



## Washing Machine

User Manual



CM 8101 BB

2820530395/ EN / 27/07/2022 16:22



## Table of Contents

|  |           |   |           |
|--|-----------|---|-----------|
| <b>1 Safety Instructions</b> .....                                 | <b>4</b>  | 6.6 Temperature Selection.....  | 25        |
| 1.1 Intended Use .....   | 4         | 6.7 Spin Speed Selection.....   | 25        |
| 1.2 Safety of Children, Vulnerable<br>Persons and Pets .....       | 4         | 6.8 Auxiliary Function Selection.....   | 26        |
| 1.3 Electrical Safety .....  | 5         | 6.8.1 Auxiliary Functions .....   | 26        |
| 1.4 Handling Safety .....  | 5         | 6.8.2 Functions/Programmes Selec-<br>ted by Pressing the Function<br>Keys for 3 Seconds ..... | 27        |
| 1.5 Installation Safety .....                                      | 6         | 6.9 End Time.....   | 28        |
| 1.6 Operational Safety.....  | 7         | 6.10 Starting the Programme.....  | 29        |
| 1.7 Maintenance and Cleaning<br>Safety .....                       | 8         | 6.11 Loading Door Lock.....   | 29        |
| <b>2 Important Instructions for Envir-<br/>onment</b> .....        | <b>9</b>  | 6.12 Changing the Selections After<br>Programme has Started.....                              | 29        |
| 2.1 Compliance with WEEE Regula-<br>tions and Waste Disposal ..... | 9         | 6.13 Cancelling the Programme .....   | 30        |
| 2.2 Package Information.....                                       | 9         | 6.14 End of Programme.....  | 30        |
| <b>3 Technical Specifications</b> .....                            | <b>10</b> | <b>7 Maintenance and Cleaning</b> .....   | <b>30</b> |
| <b>4 Installation</b> .....  | <b>11</b> | 7.1 Cleaning the Detergent Drawer ....  | 31        |
| 4.1 Appropriate Installation Location .                            | 11        | 7.2 Cleaning the Loading Door and<br>the Drum .....   | 31        |
| 4.2 Assembly of Bottom Panel Cov-<br>ers.....                      | 11        | 7.3 Cleaning the Body and Control<br>Panel.....   | 31        |
| 4.3 Removing Transportation Safety<br>Bolts.....                   | 12        | 7.4 Cleaning the Water Intake Filters..   | 31        |
| 4.4 Connecting to Water Supply .....                               | 12        | 7.5 Draining Remaining Water and<br>Cleaning the Pump Filter .....                            | 32        |
| 4.5 Connecting the Drain Hose to the<br>Drain .....                | 13        | <b>8 Troubleshooting</b> .....  | <b>33</b> |
| 4.6 Adjusting the Stands.....                                      | 13        | <b>9 DISCLAIMER / WARNING</b> .....   | <b>38</b> |
| 4.7 Electrical Connection.....                                     | 13        |   |           |
| 4.8 Start Up .....   | 14        |   |           |
| <b>5 Preparation</b> .....   | <b>14</b> |   |           |
| 5.1 Sorting the Laundry .....                                      | 14        |   |           |
| 5.2 Preparing Laundry for Washing...                               | 14        |   |           |
| 5.3 Tips for Energy and Water Sav-<br>ing.....                     | 14        |   |           |
| 5.4 Loading the Laundry.....                                       | 15        |   |           |
| 5.5 Correct Load Capacity.....                                     | 15        |   |           |
| 5.6 Using Detergent and Softener ....                              | 15        |   |           |
| 5.7 Tips for Efficient Washing.....                                | 17        |   |           |
| 5.8 Displayed Programme Duration ..                                | 18        |   |           |
| <b>6 Operating the Product</b> .....                               | <b>18</b> |   |           |
| 6.1 Control Panel.....   | 19        |   |           |
| 6.2 Symbols on the Display .....                                   | 20        |   |           |
| 6.3 Programme and Consumption<br>Table.....                        | 21        |   |           |
| 6.4 Programme Selection .....                                      | 23        |   |           |
| 6.5 Programmes .....   | 23        |   |           |

## Please read this user manual first!

---

Dear Customer,







Thank you for choosing Beko product. We hope that you get the best results from your product which has been manufactured with high quality and state-of-the-art technology. Therefore, please read this entire user manual and all other accompanying documents carefully before using the product.

Follow all warnings and information in the user manual. Thus, you protect yourself and your product against possible dangers.

Keep the user manual. If you hand over the product to someone else, provide the user manual as well. Warranty terms, usage and troubleshooting methods of your product are in user guide.

### Symbols and Definitions

The following symbols are used in the user guide:

|  |  |
|--|--|
|    | Danger that could result in death or injury.                                 |
|    | Important information or useful hints about usage.                           |
|    | Read the user manual.  |
|    | Recyclable materials.  |
| <br> | Hot surface warning.   |
| <b>WARNING</b>   | Danger that may result in property damage to the product or its environment. |

## 1 Safety Instructions

---

This section includes the safety instructions necessary to prevent the risk of personal injury or material damage.

Our company shall not be held responsible for damages that may occur if these instructions are not observed.

- Installation and repair operations shall always be performed by Authorised Service.
- Use original spare parts and accessories only.
- Do not repair or replace any component of the product unless it is clearly specified in the user manual.
- Do not modify the product.

### 1.1 Intended Use

- The product's bench life is 10 years. During this period, original spare parts will be available to operate the appliance properly.
- This product has been designed for domestic use. It is not for commercial purposes or it should not be used out of its intended use.
- The product must only be used for washing and rinsing of laundry that are marked accordingly

- This appliance is intended to be used in household and similar applications. For example;
  - Personnel kitchens of stores, offices and other work environments;
  - Ranches,
  - By customers of hotels, motels and other accommodation facilities,
  - Bed and breakfasts, hostel-like environments,
  - Common areas of apartment blocks or laundries.

### 1.2 Safety of Children, Vulnerable Persons and Pets

- This product may be used by children aged 8 years and older and persons with under-developed physical, sensory or mental capabilities or lack of experience and knowledge if they have been given supervision or instruction concerning use of the appliance in a the product safe way and the hazards involved.
- Children under the age of 3 should be kept away unless continuously supervised.
- Electrical products are dangerous for children and pets. Children or pets should not play

with, climb on top or inside the product. Check inside the product before use.

- Use child lock to prevent children from intervening with the product.
- Do not forget to close the loading door when leaving the room where the product is located. Children and pets may get locked inside and drown.
- Children should not perform cleaning and user maintenance works without an adult's supervision.
- Keep the packaging materials away from children. Risk of injury and suffocation.
- Keep all detergents and additives used for the product away from children's reach.
- Cut the power cable and break and deactivate the locking mechanism of the loading door before disposing of the product for children's safety.

### 1.3 Electrical Safety

- Product should be unplugged during installation, maintenance, cleaning and repair procedures.
- If the power cable is damaged, it must be replaced by the authorised service in order to avoid possible risks.

- Do not tuck the power cable under and behind the product. Do not place heavy objects on the power cable. Do not over bend, crush and touch the power cable to sources of heat.
- Do not use an extension cord, multi-plug or adaptor to operate your product.
- The plug shall be easily accessible. If this is not possible, a mechanism that meets the electrical legislation and that disconnects all terminals from the mains (fuse, switch, main switch, etc.) shall be available on the electrical installation.
- Do not touch the plug with wet hands.
- When unplugging the appliance, don't hold the power cord, but the plug.
- Make sure the plug is not wet, dirty or dusty.

### 1.4 Handling Safety

- Unplug the product before moving, remove the water outlet and water main connections. Drain any water left inside the product.
- The product is heavy, do not move alone. Do not hold extruding parts such as the laundry loading door to lift and

move the product. The upper tray should be tightly fixed for moving.

- Your product is heavy; it should be carried carefully by two people if a staircase is involved. It may cause injuries if your product falls on you. Do not hit and drop the product while carrying.
- Carry the product in an upright position.
- Make sure that the hoses as well as the power cable are not folded, pinched or crushed after the product is fitted into its place after installation or cleaning procedures.

### **1.5 Installation Safety**

- Check the information on the manual and installation instructions to prepare the product for installation and make sure the electrical mains, clean water mains and water outlet are suitable. If not, call a qualified electrician and plumber to have them make the necessary arrangements. These operations are the responsibility of the customer.
- Check for any damage on the product before installing it. Do not have the product installed if it is damaged.

- Injuries may occur if hands are put into uncovered slots. Close the holes of the transportation safety bolts with plastic plugs.
- Do not install or leave the product at locations where it may be exposed to external environment conditions.
- Do not install the product at locations where the temperature drops below 0 °C.
- Do not place the product on a carpet or similar surface. It would create fire hazard since it cannot receive air from underneath.
- Place the product on a level and hard surface and balance with the adjustable legs.
- Connect the product to a grounding plug protected by a fuse suitable to the current values on the type label. Make sure the grounding is carried out by an expert electrician. Do not use the product without suitable grounding to local/national regulations.
- Plug the product in a socket with voltage and frequency values suitable to those indicated on the type label.
- Do not plug the product to loose, broken, dirty, greasy sockets or sockets that has come out their seats or sockets with a risk of water contact.

- Use the new hose set provided with the product. Do not re-use old hose sets. Do not make additions to the hoses.
- Connect the water inlet hose directly to the water tap. The pressure from the tap should be minimum 0.1 MPa (1 bar) and maximum 1MPa (10 bars). 10 to 80 litres of water should be running from the tap in a minute in order for the product to function properly. If the water pressure is above 1 MPa (10 Bars), a pressure-reducing valve should be fitted. The maximum allowed temperature is 25°C.
- Fit the end of the water discharge hose to the dirty water discharge drain, the sink or the bathtub.
- Place the power cable and houses in locations without risk of tripping.
- Do not install the product behind a door, a sliding door or at another location that will prevent the door from opening completely.
- If a drier is to be placed on the product, fix with a suitable connection apparatus obtained from the authorised service.
- There is a risk of contact with electrical pieces when the upper trays is removed. Do not dismantle the upper tray of the product.
- Place the product at least 1 cm away from the edges of furniture.



## 1.6 Operational Safety

- When you are using the appliances, use only detergents, softeners and supplements suitable for washing machines.
- Do not use chemical solvents on the product. These materials contain an explosion risk.
- Do not operate defective or damaged products. Unplug the product (or turn off the fuse it is connected to), turn off the water tap and call an authorised service.
- Do not place sources of ignition (burning candle, cigarettes, etc.) or sources of heat (irons, furnaces, ovens, etc.) on top of or near the product. Do not put inflammable/explosive materials near the product.
- Do not get on the product.
- Unplug the product and turn off the tap if you will not be using the product for long periods.
- Detergent/maintenance materials may splash out of the detergent drawer if it is opened while the machine is working. Contact of the detergent with your skin and eyes is dangerous.

- Make sure pets do not climb inside the product. Check inside the product before use.
- Do not force open the locked loading door. The door will open once the washing is completed. If the door does not open, use the solutions for “loading door does not open” error in the Troubleshooting section.
- Do not wash elements contaminated with gasoline, kerosene, benzene, reducers, alcohol or other inflammable or explosive materials and industrial chemicals.
- Do not directly use dry cleaning detergent and do not wash, rinse or spin laundry contaminated with dry cleaning detergent.
- Do not place your hands into the rotating drum. Wait until the drum no longer rotates.
- Do not place your hand or a metal object under the washing machine.
- If washing laundry at high temperatures, the discharged washing water would burn your skin if in contact with your skin, for ex. when the discharge hose is connected to the tap. Do not touch the discharge water.
- Take the following precautions to prevent formation of biofilm and malodours:
  - Make sure the room where the washing machine is placed is well ventilated.
  - Wipe the door gasket and loading door glass with a dry and clean cloth at the end of the programme.
- The glass of the loading door will heat up when washing at high temperatures. Therefore, do not touch the loading door glass while washing, especially children.



## 1.7 Maintenance and Cleaning Safety

- Do not wash the product with pressure washers, by spraying vapour, water or pouring water.
- Do not use sharp or abrasive tools to clean the product. Do not use household cleaners, soap, detergent, gas, gasoline, thinner, alcohol, varnish, etc. while cleaning.
- Cleaning agents containing solvents might reek poisonous fumes( for ex. cleaning solvent. Do not use cleaning products containing solvents.



- There may be detergent residues in the detergent drawer when you open it for cleaning.
- Do not dismantle the filter of the discharge pump while the product is running.
- The temperature in the machine may rise up to 90°C. Clean the filter after the water in the machine cools down in order to avoid risk of getting burnt.

## 2 Important Instructions for Environment

---

### 2.1 Compliance with WEEE Regulations and Waste Disposal

This appliance does not contain the dangerous and prohibited materials specified in the "Regulation on The Control of Waste Electrical and Electronic Equipment" published by Ministry of Environment and Urbanisation of Republic of Turkey. Complies with WEEE Regulation.



This product was manufactured from recyclable and reusable high quality parts and materials. Therefore, do not dispose of this product with other domestic wastes at the end of its life cycle. Take it to a collection point for electrical and electronic equip-

ment. You can ask your local administration about these collection points. You can help protect the environment and natural resources by delivering the used products for recycling. Cut the power cable and break and deactivate the locking mechanism of the loading door before disposing of the product for children's safety.

---

### 2.2 Package Information

Packaging materials of the product are manufactured from recyclable materials in accordance with our National Environment Regulations. Do not dispose of the packaging materials together with the domestic or other wastes. Take them to the packaging material collection points designated by the local authorities.

### 3 Technical Specifications

|   |                  |
|---|------------------|
| Supplier's name or commercial brand     | Beko             |
| Model name                              | CM 8101 BB       |
|   | 7131820700       |
| Nominal Capacity (kg)                   | 8                |
| Maximum spin speed (cycle/min)          | 1000             |
| Built-In                                | No               |
| Height (cm)                             | 84               |
| Width (cm)                              | 60               |
| Depth (cm)                              | 55               |
| Single Water inlet / Double Water inlet | + / -            |
| Electrical input (V/Hz)                 | 220-240 V / 50Hz |
| Total current (A)                       | 10               |
| Total power (W)                         | 2000-2350        |
| Main model code                         | 1620             |

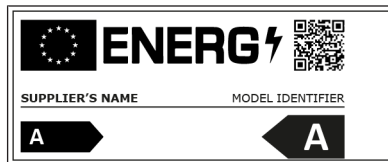

You can access technical information of the product by scanning the QR code on the energy label with a mobile device connected to the internet.

#### Symbols Table

|           |                            |                    |               |              |             |                    |       |            |                  |             |            |
|-----------|----------------------------|--------------------|---------------|--------------|-------------|--------------------|-------|------------|------------------|-------------|------------|
|           |                            |                    |               |              |             |                    |       |            |                  |             |            |
| Prewash   | Fast                       | Fast+              | Extra Rinse   | Extra Water  | Anti Crease | Pet Hair Removal   | Steam | Night Mode | Soaking          | Rinse Hold  | Sleeping   |
|           |                            |                    |               |              |             |                    |       |            |                  |             |            |
| AutoDose  | Liquid Detergent Selection | Softener Selection | Rinse         | Spin+Drain   | Drain       | Temperature        | Spin  | No Spin    | Tap Water (Cold) | No Water    | Time Delay |
|           |                            |                    |               |              |             |                    |       |            |                  |             |            |
| Door Lock | Child Lock                 | On/Off             | Start / Pause | Soil Level   | Add Garment | Downloaded Program | Wash  | Ok (End)   | Cancel           | AntiCrease+ | Drying     |
|           |                            |                    |               |              |             |                    |       |            |                  |             |            |
| Extra Dry | Cupboard Dry               | Iron Dry           | Timed Drying  | Clean & Wear |             |                    |       |            |                  |             |            |

## 4 Installation



Please read the "Safety Instructions" section first!



Your washing machine automatically detects the amount of laundry placed inside when selecting a program.

While installing the product, before the first use, calibration should be done to ensure that the laundry amount is detected in the most accurate way.

To do this, select the Drum Cleaning\* program and cancel the spin function. Start the program without laundry. Wait for the program to finish, which will take about 15 minutes.

\*The program name may vary depending on the model. For the appropriate program selection, review the program descriptions section.

- Please contact the nearest Authorised Service for the installation of the appliance.
- Make sure that the installation and electrical connections of the product are performed by authorised service agent. Manufacturer shall not be held responsible for damages caused by operations performed by unauthorised persons.
- Preparation of the location and electrical, tap water and waste water installations at the place of installation is under customer's responsibility.
- Make sure that the water inlet and discharge hoses as well as the power cable are not folded, pinched or crushed while pushing the product into its place after installation or cleaning procedures.
- Prior to installation, visually check if the product has any defects on it. Do not have the product installed if it is damaged. Damaged products cause risks for your safety.

### 4.1 Appropriate Installation Location

- Place the product on a hard and level floor. Do not place it onto a carpet with high pile or other similar surfaces. Inappropriate floor may cause problems of noise and vibration
- Total weight of the washing machine and the dryer -with full load- when they are placed on top of each other reaches to approx. 180 kilograms. Place the product on a solid and flat floor that has sufficient load carrying capacity.
- Do not place the product on the power cable.
- Do not install the product at places where temperature may fall below 0 °C. Freezing might damage your product.
- Leave a minimum space of 1 cm between the product and the furniture.
- If you will install the product on a surface with steps, never place it close to the edge.
- Do not place the product on any platform.
- Do not place heat sources such as cooker, irons, ovens, heater etc. on the appliance and do not use them on the product.

### 4.2 Assembly of Bottom Panel Covers

- In order to increase the sound comfort of the product, attach cover A after removing the package foam.

#### Cover A

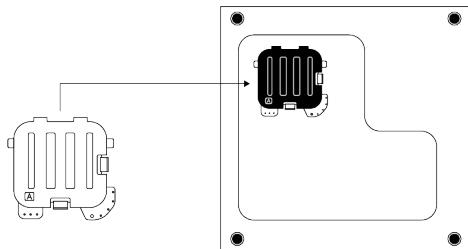

Tilt the machine back slightly. Rest the tabs of Cover A against the lower panel. Complete the assembly by rotating the cover.

- Cover B and the Cap are optional. If available, attach cover B and the Cap.

### Cover B

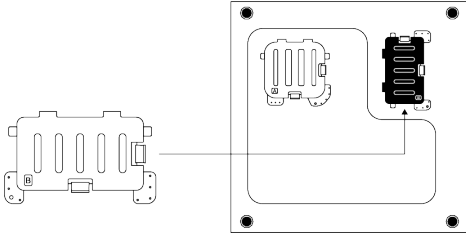

Rest the tabs of Cover B against the lower panel. Complete the assembly by rotating the cover.

### Cap

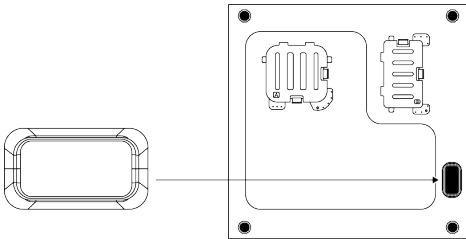

Insert the cap by pushing it with your finger.

## 4.3 Removing Transportation Safety Bolts

- Loosen all transportation safety bolts with an appropriate wrench until they turn freely.
- Bend the inner part by pressing it at the grip areas and pull the part out.
- Attach the plastic covers supplied in the User Manual bag into the holes on the rear panel.

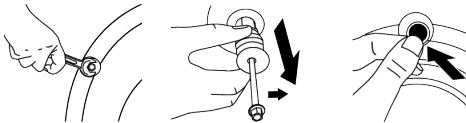

### NOTICE

Remove the transportation safety bolts before operating the product. Otherwise, the product will get damaged.



### NOTICE

Keep the transportation safety bolts in a safe place to reuse when the product needs to be moved again in the future.

Install the transportation safety bolts in reverse order of the disassembly procedure.

Never move the product without the transportation safety bolts properly fixed in place.

## 4.4 Connecting to Water Supply



### NOTICE

Models with a single water inlet shall not be connected to the hot water tap. In such a case the laundry will get damaged or the product will switch to protection mode and will not operate.

Do not use old or used water inlet hoses on a new product. It may cause water leakage from your machine and stain your laundry.

- Tighten all hose nuts by hand. Never use a tool when tightening the nuts.
- Open the taps completely after making the hose connection to check for water leaks at the connection points. If any leak occurs, turn off the tap and remove the nut. Check the gasket and tighten the nut carefully again. In order to prevent the water leaks and resultant damages, keep the taps closed when you do not use the product.

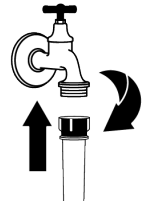

## 4.5 Connecting the Drain Hose to the Drain

- a. Attach the end of the drain hose directly to waste water drain, washbasin or bathtub.



Your house will be flooded if the water draining hose is dislocated during water draining. There is also a risk of burning due to the high washing temperatures. In order to prevent such situations and make sure that the product performs water intake and drain processes without any problem, fix the drain hose securely.

- b. Connect the drain hose to a minimum height of 40 cm and a maximum height of 100 cm.
- c. Installing the water draining hose at ground level or close to the floor (40 cm below) and then raising it makes water discharge difficult and the laundry may come out extremely wet. Thus, follow the heights provided in the figure.

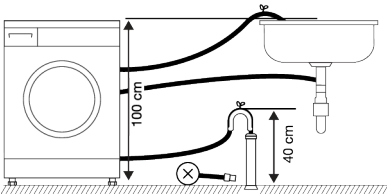

- d. To prevent the waste water to go back into the product again and to ensure easy drainage, do not immerse the end of the hose into the waste water or do not insert it into the drain for more than 15 cm. If it is too long, cut it short.
- e. The end of the hose should not be bent, it should not be stepped on and the hose must not be pinched between the drain and the product. Otherwise, water discharge issues may emerge.
- f. If the length of the hose is too short, use it by adding an original extension hose. The overall length of the hose shall not be longer than 3.2 m. To prevent water leaks, always secure the connection

between the extension hose and the draining hose of the product with a suitable clamp so that it does not come off and cause leaks.

## 4.6 Adjusting the Stands



### NOTICE

In order to ensure that the product operates more silently and vibration-free, it must stand level and balanced on its feet. Ensure that the product is balanced by adjusting the feet. Otherwise, the product may move from its place and cause crushing, noise and vibration problems.

To avoid damaging the lock nuts, do not use any tools to loosen the nuts.

- a. Loosen the lock nuts on the feet by hand.
- b. Adjust the feet until the product stands level and balanced.
- c. Tighten all lock nuts again by hand.

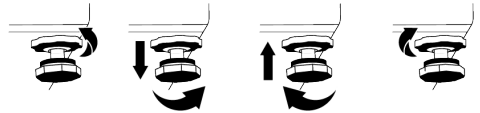

## 4.7 Electrical Connection

Connect the product to a grounded outlet protected by a 16 A fuse. Our company shall not be responsible for the damages that shall be incurred due to using the product without grounding according to local regulations.

- Connection must comply with national regulations.
- The electrical connection cable infrastructure of the product must be adequate and suitable for product requirements. It is recommended to use a residual current device.
- Power cable plug must be within easy reach after installation.
- If the current supply to the fuse or breaker in the house is less than 16 Amps, have a qualified electrician install a 16 amp supply.

- The voltage specified in the "Technical specifications" section must be equal to your mains voltage.
- Do not make connections via extension cables or multi-plugs. Overheating and burning may occur due to the connecting cable.



Damaged power cables should be replaced by the authorised service in order to prevent possible danger.

## 4.8 Start Up

Before starting to use the product make sure that the preparations described in section "Environmental instructions" and "Installation". To prepare the product for

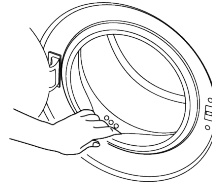

Some water has remained in the product due to the quality control processes in the production. It is not harmful for the product.

## 5 Preparation



Please read the "Safety Instructions" section first

### 5.1 Sorting the Laundry

- Sort laundry according to type of fabric, colour, and degree of soiling and allowable water temperature.
- Always observe the instructions given on the garment care labels.

### 5.2 Preparing Laundry for Washing

- Laundry items with metal attachments such as, underwiring, belt buckles or metal buttons will damage the product. Remove the metal pieces or wash such clothes by putting them in a laundry bag or pillow case.
- Take out all substances in the pockets such as coins, pens and paper clips, and turn pockets inside out and brush. Such objects may damage the product or cause noise problem.
- Put small size clothes such as infant's socks and nylon stockings in a laundry bag or pillow case.

- Place curtains in without compressing them. Remove curtain attachment items. Curtain attachment items may cause pulling and tearing on the curtain.
- Fasten zippers, sew loose buttons and mend rips and tears.
- Wash "Machine washable" or "Hand washable" labelled products only with an appropriate programme.
- Do not wash colours and whites together. New, dark coloured cottons release a lot of dye. Wash them separately.
- Tough stains must be treated properly before washing.
- Wash trousers and delicate laundry turned inside out.
- Laundry that are subjected to materials such as flour, lime dust, milk powder, etc. intensely must be shaken off before placing into the product. Such dusts and powders on the laundry may build up on the inner parts of the product in time and can cause damage.

### 5.3 Tips for Energy and Water Saving

Following information will help you use the product in an ecological and energy/water-efficient manner.

- Operate the product in the highest load capacity allowed for the programme you have selected, but do not overload. See "Programme and consumption table"
- Observe the temperature instructions on the detergent packaging.
- Wash slightly soiled laundry at low temperatures.
- Use faster programmes for small quantities of lightly soiled laundry.
- Do not use prewash and high temperatures for laundry that is not heavily soiled or stained.
- If you plan to dry your laundry in a dryer, select the highest spin speed recommended during washing process.
- Do not use more detergent than the recommended amount on the detergent packaging.

#### 5.4 Loading the Laundry

- Open the loading door.
- Put the laundry items into the product in a loose manner.
- Push the loading door to close until you hear a locking sound. Ensure that no items are caught in the door. The loading door is locked while a programme is running. The door lock will open once the programme is completed. Then you can open the loading door. If the door does not open, apply the solutions provided for "Loading door cannot be opened" error in the Troubleshooting section.

#### 5.5 Correct Load Capacity

The maximum load capacity depends on the type of laundry, the degree of soiling and the desired washing programme. The product automatically adjusts the water amount according to the weight of the laundry put inside it.

**i** Follow the instructions in "Programme and consumption table". When the appliances is overloaded product's washing performance will drop. Moreover, noise and vibration problems may occur.

#### 5.6 Using Detergent and Softener



##### WARNING

Read the manufacturer instructions on the package while using detergents, softeners, starch, bleach and decolourants, anti-limescale and follow the dosage information provided. Use a measuring cup, if any.

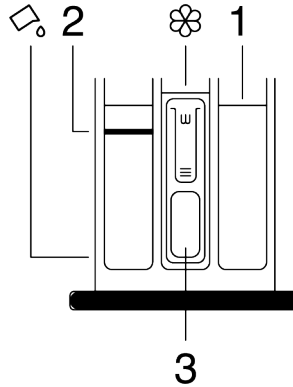

The detergent drawer comprises of three compartments:

- (1) for prewash,
  - (2) for main washing,
  - (3) for softener,
- (☞) a syphon piece in the softener compartment,
- (☞) there is a liquid detergent apparatus for liquid detergent use in the main washing compartment.

##### Detergent, Softener and Other Cleaning Agents

- Add detergent and softener before starting the washing programme.
- Do not leave the detergent drawer open when the washing programme is on.
- If you are using a programme without pre-washing, do not put detergent in the pre-wash compartment (compartment no. "1").
- If you are using a program with prewash, start the machine after adding powder detergent to the prewash and main wash compartments (compartments 1 and 2).

- Do not select a programme with pre-washing if you are using a detergent pod or dispensing ball. Place the detergent pod or the dispensing ball directly among the laundry in the product.
- If you are using a liquid detergent, follow the directions under “Liquid detergent use” and do not forget to bring the liquid detergent apparatus to the correct position.

### Choosing the Detergent type

Detergent type to be used depends on the washing programme, fabric type and colour.

- Use different detergents for coloured and white laundry.
- Wash your delicate clothes only with special detergents (liquid detergent, wool shampoo, etc.) intended solely for delicate clothes and at suggested programmes.
- When washing dark coloured clothes and quilts, it is recommended to use liquid detergent.
- Wash woollens at suggested programme with special detergent made specifically for woollens.
- Please review the programme descriptions part for suggested programme for different textiles.
- All recommendations about detergents are valid for selectable temperature range of programmes.



Only detergents, softeners and additives suitable for washing machines should be used.  
Do not use soap powder.

### Adjusting the Detergent Amount

The amount of detergent depends on the amount of laundry, how soiled they are and the water hardness.

- Do not exceed the recommended dosage values on the detergent packaging in order to eliminate excessive foam and poor rinsing problems, to save money and protect the environment.
- Use less amounts of detergent for fewer or less soiled laundry.

### Using Softeners

Put the softener in the softener compartment of the detergent drawer.

- Do not exceed the (>max<) level sign in the softener compartment.
- If the softener is not fluid, dilute with water before placing in the softener compartment.



#### WARNING

Do not use liquid detergents or other materials with cleaning properties unless they are intended for use in washing machines for softening the laundry.

### Using Liquid Detergents

#### If the Product Has a Liquid Detergent Apparatus

- Press and rotate the apparatus at where it is shown when you want to use liquid detergents. The part falling below will serve as a barrier for liquid detergent.
- Clean with water at its place or by removing from its place when it is necessary. Do not forget to place the apparatus in the main washing compartment (compartment no. “2”) after cleaning.
- The apparatus should be up if you will use a powder detergent. The fan that you would see in this position will mix the powder detergent and help it to dissolve.

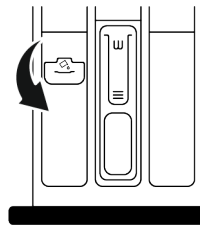

### Use of Gel and Tablet Detergents

- If the detergent is fluid and there is no liquid detergent compartment in your product, place the gel detergent in the main washing detergent compartment in first water intake. If your product has a liquid detergent compartment, fill the compartment with detergent before starting the programme.



- If the gel detergent is not fluid or is in a capsule liquid tablet, place directly inside the drum before washing.
- Put the tablet detergent in the main washing compartment (compartment no. "2") or directly inside the drum before washing.

### Using Starch

- Put in the liquid starch, powder starch or fabric dye in the softener compartment.
- Do not use softener and starch in the same washing programme simultaneously.
- Wipe the inside of the product with a damp and clean cloth after using starch.

### Using Anti-Limescale

- When necessary, only use anti-limescale produced for washing machines.

### Using Bleach and Decolourants

- Select a programme with pre-washing and add bleach at the start of pre-washing. Do not put detergent in the pre-wash compartment. As an alternative application, select a programme with additional

- rinsing and add the bleach while the product is receiving water to the detergent compartment in the first rinsing step.
- Do not mix and use bleach and detergent together.
- As bleach may cause skin irritation use only small amounts (1/2 tea cups - approximately 50 ml and rinse the laundry well.
- Do not pour bleach directly onto the laundry.
- Do not use bleach for coloured clothes.
- Select a programme with low temperature washing while using oxygen-based decolourants.
- Oxygen-based decolourants can be used together with detergents. However, if it does not have the same viscosity as the detergent, first place the detergent in compartment no. "2" in the detergent drawer and wait for the product to rinse away the detergent during water intake. Add the decolourant to the same compartment while the machine continues taking in water.

## 5.7 Tips for Efficient Washing

|  | Clothes   |  |  |  |
|--|---|--|--|--|
|  | Light Colours and Whites                                      | Colours  | Black/Dark Colours   | Delicates/Woolens/Silks  |
|  | (Recommended temperature range based on soil level: 40-90 °C) | (Recommended temperature range based on soil level: cool -40 °C) | (Recommended temperature range based on soil level: cool -40 °C) | (Recommended temperature range based on soil level: cool -30 °C) |

|                      |  |  |  |  |   |
|----------------------|--|--|--|--|---|
| <b>Soiling Level</b> | <p><b>Heavily Soiled</b><br/>(difficult stains such as grass, coffee, fruits and blood.)</p> | <p>It may be necessary to pre-treat the stains or perform prewash.</p> <p>Powder and liquid detergents recommended for whites can be used at dosages recommended for heavily soiled clothes. It is recommended to use powder detergents to clean clay and soil stains and the stains that are sensitive to bleaches.</p> | <p>Powder and liquid detergents recommended for colours can be used at dosages recommended for heavily soiled clothes. It is recommended to use powder detergents to clean clay and soil stains and the stains that are sensitive to bleaches. Detergents which do not contain decolourant should be used.</p> | <p>Liquid detergents suitable for colours and black/dark colours can be used at doses recommended for heavily soiled clothes.</p>    | <p>Prefer liquid detergents produced for delicate clothes. Woollen and silk clothes must be washed with special woollen detergents.</p> |
|                      | <p><b>Normally Soiled</b><br/>(For example, stains caused by body on collars and cuffs)</p>  | <p>Powder and liquid detergents recommended for whites can be used at dosages recommended for normally soiled clothes.</p>   | <p>Powder and liquid detergents recommended for colours can be used at dosages recommended for normally soiled clothes. Detergents which do not contain decolourant should be used.</p>  | <p>Liquid detergents suitable for colours and black/dark colours can be used at doses recommended for moderately soiled clothes.</p> | <p>Prefer liquid detergents produced for delicate clothes. Woollen and silk clothes must be washed with special woollen detergents.</p> |
|                      | <p><b>Lightly Soiled</b><br/>(No visible stains exist.)</p>                                  | <p>Powder and liquid detergents recommended for whites can be used at dosages recommended for lightly soiled clothes.</p>  | <p>Powder and liquid detergents recommended for colours can be used at dosages recommended for lightly soiled clothes. Detergents which do not contain decolourant should be used.</p>   | <p>Liquid detergents suitable for colours and black/dark colours can be used at doses recommended for lightly soiled clothes.</p>    | <p>Prefer liquid detergents produced for delicate clothes. Woollen and silk clothes must be washed with special woollen detergents.</p> |

## 5.8 Displayed Programme Duration

You can view the programme duration on the display of your machine while selecting a programme. Depending on the amount of laundry you have loaded into your machine, foaming, unbalanced load conditions, fluctuations in power supply, water pressure and programme settings, the programme duration is automatically adjusted while the programme is running.

**SPECIAL CASE:** At programme start of Cottons and Cotton Eco programmes, display shows the duration of half load. It is the most common use case. After programme starts, in 20-25 minutes actual load is detected by the machine. And if the detected load is higher than half load; washing programme will be adjusted accordingly and programme duration increased automatically. You can follow this change on the display.

## 6 Operating the Product



Please read the "Safety Instructions" section first!

## 6.1 Control Panel

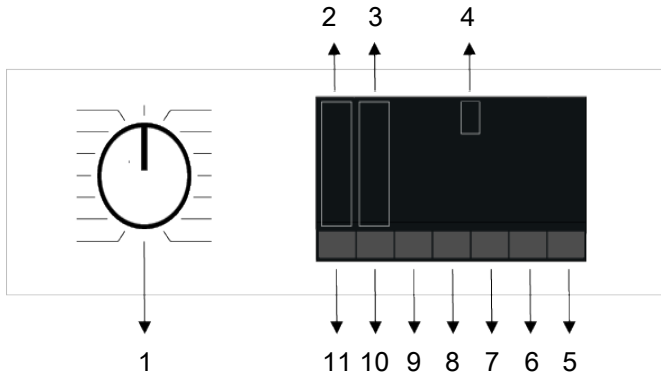

- 1 Programme Selection Button
- 3 Spin Level Indicator Lights
- 5 Start/Pause Button
- 7 Auxiliary Function Button 3
- 9 Auxiliary Function Button 1
- 11 Temperature Setting Button

- 2 Temperature Level Indicator Lights
- 4 Display
- 6 End Time Setting Button
- 8 Auxiliary Function Button 2
- 10 Spin Speed Adjustment Button

## 6.2 Symbols on the Display

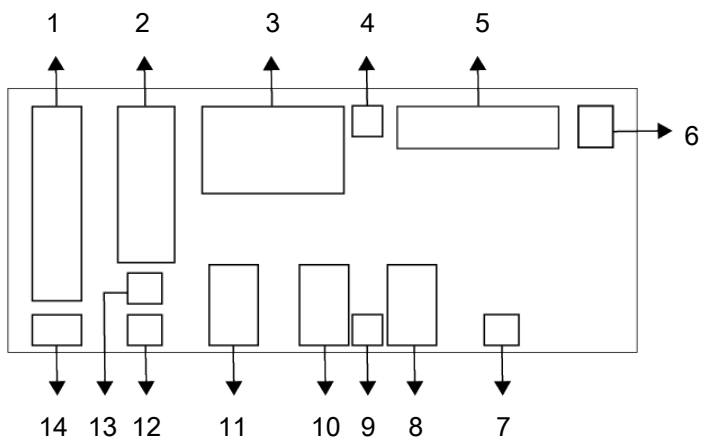

- |                                    |                                    |
|------------------------------------|------------------------------------|
| 1 Temperature Indicator            | 2 Spin Speed Indicator             |
| 3 Duration information             | 4 Door lock is engaged symbol      |
| 5 Programme follow-up indicator    | 6 No Water indicator               |
| 7 Delayed Start Enabled Indicator  | 8 Auxiliary Function Indicators 3  |
| 9 Child Lock Enabled symbol        | 10 Auxiliary Function Indicators 2 |
| 11 Auxiliary Function Indicators 1 | 12 No spin indicator               |
| 13 Rinse Hold Indicator            | 14 Cold Water indicator            |



The visuals used for machine description in this section are schematic and may not match exactly with the features of your machine.

## 6.3 Programme and Consumption Table

| Programme                            |                |                |                       |                          |            | Auxiliary Functions |             |           |              |               | Temperature °C |
|--------------------------------------|----------------|----------------|-----------------------|--------------------------|------------|---------------------|-------------|-----------|--------------|---------------|----------------|
|                                      | Temperature °C | Max. Load (kg) | Water Consumption (l) | Energy Consumption (kWh) | Max. Speed | Buhar               | Extra Water | Ön Yıkama | Anti-Crease+ | Hızlı / Yoğun |                |
| Pamuklu                              | 90             | 8              | 96                    | 2,40                     | 1000       | *                   | *           | *         | *            | *             | Cold - 90      |
|                                      | 60             | 8              | 96                    | 1,80                     | 1000       | *                   | *           | *         | *            | *             | Cold - 90      |
|                                      | 40             | 8              | 95                    | 0,97                     | 1000       | *                   | *           | *         | *            | *             | Cold - 90      |
| Eko 40-60                            | 40             | 8              | 60                    | 0,905                    | 1000       |                     |             |           |              |               | 40-60          |
|                                      | 40             | 4              | 40                    | 0,615                    | 1000       |                     |             |           |              |               | 40-60          |
|                                      | 40             | 2              | 29                    | 0,325                    | 1000       |                     |             |           |              |               | 40-60          |
| Sentetik                             | 60             | 3              | 70                    | 1,35                     | 1000       | *                   | *           | *         | *            | *             | Cold - 60      |
|                                      | 40             | 3              | 68                    | 0,85                     | 1000       | *                   | *           | *         | *            | *             | Cold - 60      |
| Ekspres / Ekspres 14                 | 90             | 8              | 66                    | 2,20                     | 1000       | *                   | *           |           | *            | *             | Cold - 90      |
|                                      | 60             | 8              | 66                    | 1,20                     | 1000       | *                   | *           |           | *            | *             | Cold - 90      |
|                                      | 30             | 8              | 66                    | 0,20                     | 1000       | *                   | *           |           | *            | *             | Cold - 90      |
| Ekspres / Ekspres 14 + Hızlı / Yoğun | 30             | 2              | 40                    | 0,15                     | 1000       | *                   | *           |           | *            | *             | Cold - 90      |
| Yünlü / Elde Yıkama                  | 40             | 1,5            | 55                    | 0,50                     | 1000       |                     | *           |           |              |               | Cold - 40      |
| Spor                                 | 40             | 3,5            | 55                    | 0,50                     | 1000       |                     |             | *         |              |               | Cold - 40      |
| Karma                                | 40             | 3,5            | 85                    | 0,90                     | 800        | *                   | *           | *         | *            | *             | Cold - 40      |
| Kazan Temizleme                      | 90             | -              | 76                    | 2,33                     | 600        | *                   |             |           |              |               | 90             |
| Leke Programı                        | 40             | 4              | 85                    | 1,55                     | 1000       |                     |             | *         |              | *             | 30-60          |
| Nevresim                             | 60             | 2              | 89                    | 1,31                     | 1000       | *                   | *           |           |              |               | Cold - 60      |
| Gömlük                               | 60             | 3              | 70                    | 1,40                     | 800        | *                   |             | *         | *            | *             | Cold - 60      |
| Bebek+                               | 90             | 8              | 125                   | 2,90                     | 1000       | *                   |             |           |              |               | 20-90          |
| Buharlı Havalandırma                 | -              | 1              | 1,1                   | 0,11                     | -          | *                   |             |           |              |               | -              |

\* : Selectable.

\* : Automatically selected, cannot be cancelled.

\*\*\* : Eco 40-60 programme is a test programme according to 40 ° C temperature selection, EU regulation EU / 2019/2014 and EN 60456: 2016 / A11: 2020 standard.  
- : See the programme description for maximum load.



Please read Installation section of the manual before first use. The auxiliary functions in the table may vary according to the model of your machine.

Water and energy consumption may vary subject to the changes in water pressure, water hardness and temperature, ambient temperature, type and amount of laundry, selection of auxiliary functions and spin speed, and changes in electric voltage.

Selection patterns for auxiliary functions can be changed by the manufacturer company. New selection patterns can be added or removed.

The spin speed of your machine may vary according to the programme; this spin speed cannot exceed the max. spin speed of your machine.

The amount of noise and humidity varies according to the spin speed; when the higher spin speed is selected during the spinning phase, the laundry contains less moisture but higher noise occurs at the end of the programme.



You can see the washing duration on the display of your machine while selecting a programme. Depending on the amount of laundry you have loaded into your machine, there may be a difference of 1-1.5 hours between the duration shown on the display and the actual duration of the wash cycle. Duration will be automatically updated soon after the washing starts.

Always select the lowest appropriate temperature. The most efficient programmes in terms of energy consumption are generally those that wash at low temperatures for a long time.

Consumption Values (EN)

|                      | Temperature Selection °C | Spin Speed (cycle/min) | Capacity (kg) | Programme Duration (h:min) | Energy Consumption (kWh/cycle) | Water Consumption (liter/cycle) | Laundry Temperature (°C) | Residual Moisture Percent (%) |
|----------------------|--------------------------|------------------------|---------------|----------------------------|--------------------------------|---------------------------------|--------------------------|-------------------------------|
| Eko 40-60            | 40                       | 1000                   | 8             | 03:38                      | 0,905                          | 60                              | 37                       | 62                            |
|                      | 40                       | 1000                   | 4             | 02:47                      | 0,615                          | 40                              | 38                       | 60                            |
|                      | 40                       | 1000                   | 2             | 02:47                      | 0,325                          | 29                              | 28                       | 66                            |
| Pamuklu              | 20                       | 1000                   | 8             | 03:30                      | 0,600                          | 95                              | 20                       | 62,9                          |
|                      | 60                       | 1000                   | 8             | 03:30                      | 1,800                          | 96                              | 60                       | 62,9                          |
| Sentetik             | 40                       | 1000                   | 3             | 02:15                      | 0,850                          | 68                              | 40                       | 45                            |
| Ekspres / Ekspres 14 | 30                       | 1000                   | 8             | 00:28                      | 0,200                          | 66                              | 23                       | 62                            |

The consumption values given for programmes other than the Eco 40-60 programme are only indicative.

## 6.4 Programme Selection

- a. Determine the programme suitable for the type, quantity and soiling level of the laundry in accordance with "Programme and consumption table".



Programmes are limited with the highest spin speed appropriate for that particular type of fabric. When selecting a programme, always consider the type of fabric, colour, degree of soiling and permissible water temperature.

- b. Select the desired programme with the Programme Selection knob.

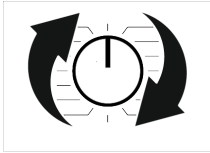

## 6.5 Programmes

### • Eko 40-60

In the Eco 40-60 programme, you may wash normally soiled cotton laundry that are specified to be washed together at 40°C or 60°C. This programme is the standard test programme according to the EU environmentally friendly design and energy labelling regulations.

Although this programme washes longer than other washing programmes, it is more efficient in terms of energy and water consumption. Actual water temperature may be different from the stated wash temperature. When you load the machine with less laundry (e.g. ½ capacity or less), periods in programme stages may automatically get shorter. In this way, energy and water consumption would be much less.

### • Pamuklu

You can wash your durable cotton laundry (sheets, bedlinen, towels, bathrobes, underwear etc.) in this programme. When the

quick wash function button is pressed, programme duration becomes notably shorter but effective washing performance is ensured with intense washing movements. If the quick wash function is not selected, effective washing and rinsing performance is ensured for your heavily soiled laundry.

### • Sentetik

You can wash your laundry (such as shirts, blouses, synthetic/cotton blended fabrics etc.) in this programme. When the quick wash function button is pressed, the programme duration will be shortened significantly and effective washing performance is provided for your laundry that is not very dirty. If the quick wash function is not selected, effective washing and rinsing performance is ensured for your heavily soiled laundry.

### • Yünlü / Elde Yıkama

Use to wash your woollen/delicate laundry. Select the appropriate temperature complying with the tag of your clothes. Your laundry will be washed with a very gentle washing action in order not to damage the clothes.

### • Bebek+

Applying a steam step at the beginning of the programme allows to soften the dirt easily.

Use this programme for your laundry (baby clothes, bed sheets, bedlinen, underwear, etc. cotton items) that requires an anti-allergic and hygienic washing at high temperature with intensive and long washing cycle. The high level of hygiene is ensured thanks to the steam application before the programme, long heating duration and additional rinsing step.

- Programme was tested by „The British Allergy Foundation„ (Allergy UK) with the 60°C temperature option selected and it was certified in terms of its efficacy in eliminating allergens in addition to bacteria and mould.



Allergy UK is the brand of the British Allergy Association. Seal of Approval is created to guide people that require recommendation about a product that the related product restricts / reduces / eliminates the allergens or reduces the allergen content significantly in the ambient where allergy patients exist. It aims to provide assurance that the products are tested scientifically or examined in a way to provide measurable results.

#### • **Nevresim**

Use this programme to wash your coats, vest, jackets etc. containing feathers with a "machine-washable" label on them. Thanks to special spinning profiles, it is ensured that the water reaches the air gaps amongst the feathers.

#### • **Sıkma+Pompa**

You can use this program to remove the water on the garment/inside the machine.

#### • **Durulama**

Use when you want to rinse or starch separately.

#### • **Buharlı Havalandırma**

Use this programme to reduce the creases and ironing times of a small amount of unspotted cotton, synthetic or mixed laundry.

#### • **Gömlek**

This programme is used to wash the shirts made from cotton, synthetic and synthetic blended fabrics altogether. It reduces wrinkles. Steam is applied at the end of the programme to help the wrinkle reducing function. The special spin profile and steam applied at the end of the programme reduce the wrinkles on your shirts. When the quick wash function is selected, the Pre-treatment algorithm is executed.

- Apply the pre-treatment chemical on your garments directly or add it together with the detergent in the powder detergent compartment. Thus, you can obtain the same performance as you obtain with normal washing in a much shorter period of time. Usage life of your shirts in-

creases. Do not use pre-wash detergent if you are planning to use delay function of your machine. Prewash detergent may pour out on your clothes and cause stains.

\*\* It is recommended to operate the cycle with no more than 6 shirts to minimize wrinkles in your shirts using this cycle. When washing more than 6 shirts, there may be differences on the wrinkle levels and humidity on shirts at the end of cycle.

#### • **Ekspres / Ekspres 14**

Use this programme to wash your lightly soiled or unspotted cotton clothes in a short time but not for towels or heavy cottons.

The programme duration can be reduced down to 14 minutes when the quick wash function is selected. When the quick wash function is selected, maximum 2 (two) kg of laundry must be washed.

#### • **Kazan Temizleme**

Regularly clean (once every 1 to 2 months) the drum for ensuring the required hygiene. Turn on the programme when the machine is completely empty. For better results, use powder anti-limescale (drum cleaning materials) suitable for washing machines when the powder detergent function is selected. Leave the loading door half closed after the programme ends for the inside of the machine to dry.



This is not a washing programme. This is a maintenance programme. Do not turn this programme on when there is something inside the machine. When you attempt to operate, the machine automatically senses that there is load inside, and may quit or resume the programme as per the model of your machine. An effective cleaning is not achieved if the programme is resumed.

#### • **Karma**

Use to wash your cotton and synthetic clothes together without sorting them.



## • Spor

You can use this programme to wash sports and outdoors garments that contain cotton/synthetics mix and water repellent covers such as gore-tex etc. It makes sure your garments are washed gently thanks to special rotating movements.

## • Leke Program

The machine has a special stain programme which enables the removal of different types of stains in the most effective way. Use this programme only for durable colourfast cotton laundry. Do not wash delicate and pigmenting clothes and laundry in this programme. Before washing, garment tags should be checked (recommended for cotton shirts, trousers, shorts, t-shirts, baby clothes, pyjamas, aprons, table clothes, bed sheets, duvet covers, pillowcases, bath-beach towels, towels, socks, cotton underwear that are suitable for washing at high temperature and long time).

In the automatic stain programme, you can wash 24 types of stains divided into three different groups according to quick function selection. Depending on the selected stain group, a special washing programme for which duration of rinse hold, washing action, washing and rinsing duration are modified.

**Below you can find the soil groups that can be selected with the “Quick/Intensive” setting button:**

### When “Intense” is selected;

Sweat, collar dirt, food, mayonnaise, salad dressing, make-up, machine oil, baby food.

### When “Quick/Intense” is not selected;

Blood, chocolate, pudding, grass, mud, eggs, butter, curry.

### When “Quick” is selected;

Tea, coffee, juice, ketchup, red wine, cola, jam, coal

- Select the stain programme.
- Select the stain you want to clean by locating it in the groups above and selecting the related group with the Quick/Intense auxiliary function button.

- Read the garment tag carefully and ensure that correct temperature and spin speed are selected.

## 6.6 Temperature Selection

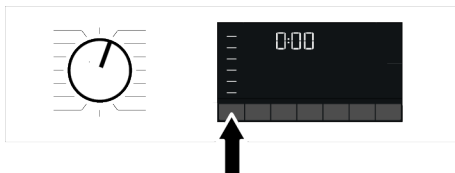

Whenever a new programme is selected, the recommended temperature for the programme appears on the temperature indicator. It is possible that the recommended temperature value is not the maximum temperature that can be selected for the current programme.

Press the Temperature Adjustment button to change the temperature. Temperature decreases gradually.

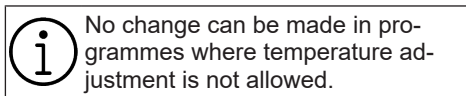

No change can be made in programmes where temperature adjustment is not allowed.

You can also change the temperature after the washing starts. This change can be made if the only washing steps allow it.

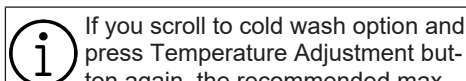

If you scroll to cold wash option and press Temperature Adjustment button again, the recommended maximum temperature for the selected programme appears on the display. Press the Temperature Adjustment button again to decrease the temperature.

## 6.7 Spin Speed Selection

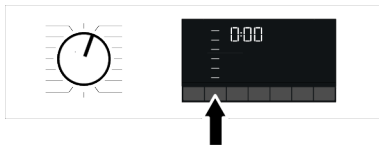



Whenever a new programme is selected, the recommended spin speed of the selected programme is displayed on the Spin Speed indicator. It is possible that the re-

commended spin speed value is not the maximum spin speed that can be selected for the current programme.

Press the Spin Speed Adjustment button to change the spin speed. Spin speed decreases gradually.

Then, depending on the model of the

product, "Rinse Hold  " and "No Spin  " options appear on the display.

If you are not going to unload your laundry immediately after the programme completes, you can use Rinse Hold function in order to prevent them from getting wrinkled when there is no water in the machine.

This function holds the laundry in the final rinsing water. If you want to spin your laundry after the Rinse Hold function:

- a. Adjust the Spin Speed.
- b. Press Start / Pause. The programme will resume. Machine drains the water and spins the laundry.

If you want to drain the water at the end of the programme without spinning, use No Spin function.



No change can be made in programmes where spin speed adjustment is not allowed.

You can change the spin speed after the washing starts if the washing steps allow it. Changes cannot be made if the steps do not allow it.

### Rinse Hold

If you are not going to unload your clothes immediately after the programme completes, you can use rinse hold function to keep your laundry in the final rinsing water in order to prevent them from getting wrinkled when there is no water in the machine. Press Start/Pause button after this process if you want to drain the water without spinning your laundry. Programme will resume and complete after draining the water.

If you want to spin the laundry held in water, adjust the Spin Speed and press Start/Pause button. The programme will resume. Water is drained, laundry is spun and the programme is completed.

## 6.8 Auxiliary Function Selection

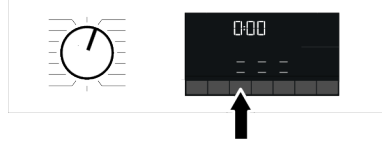

Select the desired auxiliary functions before starting the programme. Whenever a programme is selected, icons of the auxiliary function symbol that is selected together with it illuminates.



When an auxiliary function button that cannot be selected with the current programme is pressed, the washing machine will make a warning sound.

Some functions cannot be selected together. If a second auxiliary function conflicting with the first one is selected before starting the machine, the function selected first will be cancelled and the second auxiliary function selection will remain active.

An auxiliary function that is not compatible with the programme cannot be selected (See "Programme and consumption table") Some programmes have auxiliary functions that must be operated simultaneously. Those functions cannot be cancelled.

### 6.8.1 Auxiliary Functions

#### • Ön Yıkama

A Prewash is only worthwhile for heavily soiled laundry. Not using the Prewash will save energy, water, detergent and time.

#### • Hızlı / Yoğun

You can shorten or extend the programme duration with this function. Depending on the programme selection, there may be dif-

ferences in time increases and decreases. In case the FAST or INTENSIVE led is not lit, the appropriate programme duration is shown for your normally soiled clothes/laundry.

Depending on the programme selection, the Intensive feature can be selected automatically. In this case, the Intensive LED on the panel will be lit. You can use the Intensive selection to achieve a better washing performance when washing heavily soiled laundry.

You can reduce the time for your lightly soiled laundry by pressing the Fast/Intensive button in the programmes which come with intense being selected. When you press the button once, the LED will turn off and you will reach the appropriate programme duration for your normally soiled clothes/laundry. When you press the same button a second time, the fast LED will light up, the time will decrease a little and it will show the minimum programme duration, which is suitable for your less soiled laundry. The duration of programmes may shorten by 50% when this function is selected. While the duration shortens, due to optimized washing steps, mobility and optimum water consumption of the high mechanics, high washing performance is achieved.

#### • **Buhar**

This function helps to reduce the creases of your cotton, synthetic and mixed clothes, shorten the ironing time and remove the dirt by softening.

\* Under conditions where the steam function is applied at the end of the programme, your laundry may be warmer at the end of the washing. This is expected within the programme working conditions.



When you activate the steam function, do not use liquid detergent if there is no liquid container or liquid detergent dosing feature. There is the risk of staining of the clothes.

## 6.8.2 Functions/Programmes Selected by Pressing the Function Keys for 3 Seconds

### • **Anti-Crease+** 3"

This function is selected when the relevant Auxiliary function button is pressed and held for 3 seconds and the programme follow-up light for the relevant step turns on. When the function is selected, the drum rotates for up to 8 hours for preventing the laundry from creasing at the end of the programme. You can cancel the programme and take your laundry out at any time during the 8-hour duration. Press the function selection key or the machine on/off key to cancel the function. The programme follow-up light will remain on until the function is cancelled or the step is complete. If the function is not cancelled, it will be active in the subsequent washing cycles as well.

### • **Extra Water** 3"

This function can be selected by pressing and holding the related auxiliary function button for 3 seconds.

This function allows you to wash with plenty of water and rinse your laundry in all the programmes indicated as selectable in the Programme and Consumption table. Use this function for delicate laundry that creases easily.



When you select this function, load your machine with half of the maximum load specified in the programme table.

### • **Child Lock** 3"

Use Child Lock function to prevent children from tampering with the machine. Thus you can avoid any changes in a running programme.



You can switch on and off the machine with On / Off button when the Child Lock is active. When you switch on the machine again, programme will resume from where it has stopped.

When the Child Lock is enabled, an audio warning will be given if the buttons are pressed. Audio warning will be cancelled if the buttons are pressed five times consecutively.

### To activate the child lock:

Press and hold the related auxiliary function button for 3 seconds. After the countdown as "3-2-1" on the display is over, Child Lock symbol appears on the display. When this warning is displayed, you can release the Auxiliary Function button 3.

### To deactivate the child lock:

Press and hold the related auxiliary function button for 3 seconds. After the countdown as "3-2-1" on the display is over, Child Lock symbol disappears.

## 6.9 End Time

### Time display

When the end time function is selected, the remaining time until the programme starts is shown in hours such as 1h, 2h, and the remaining time to complete the programme after your programme starts is shown in hours and minutes as in the 01:30 example.



Programme duration may differ from the values in section "Programme and consumption table" depending on the water pressure, water hardness and temperature, ambient temperature, amount and the type of laundry, auxiliary functions selected and the changes at the mains voltage.

After a certain period of time after the end time function is activated, the machine goes into standby mode and some LEDs on the screen turn off. If there is any user input, the LEDs will turn on again.

With the End Time function, the end time of the programme may be set up to 24 hours. After pressing End Time button, the programme's estimated ending time is displayed. If the End Time is set, End Time indicator is illuminated.

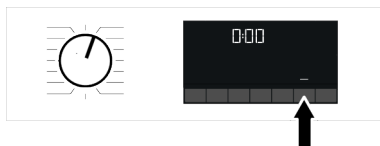

In order for the End Time function is activated and the programme is completed at the end of the specified time, you must press Start/Pause button after adjusting the time.

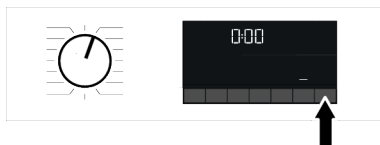

If you want to cancel End Time function, press On/Off button to turn off and on the machine.



When you have activated the End Time function, do not add liquid detergent in the powder detergent compartment no 2. There is the risk of staining of the clothes

- Open the loading door, place the laundry and put detergent, etc.
- Select the washing programme, temperature, spin speed and, if required, the auxiliary functions.
- Set the End Time of your choice by pressing the End Time button. End Time indicator lights.
- Press Start / Pause. Time countdown starts.



Additional laundry can be added into the machine during the End Time countdown. At the end of the countdown, End Time indicator turns off, washing cycle starts and the time of the selected programme appears on the display.



To avoid any water overflow before opening the loading door, make sure there is no water left inside the machine.

## 6.10 Starting the Programme

- Press Start / Pause button to start the programme.

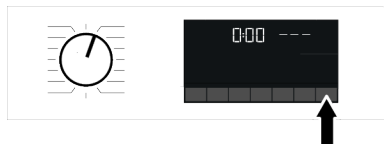

- The Start / Pause button's light which was off before starts to illuminate steadily now, indicating that the programme has started.
- Loading door is locked. The door lock symbol appears on the display after the loading door is locked.
- Programme follow-up indicator lights on the display will show the current programme step.

## 6.11 Loading Door Lock

There is a locking system on the loading door of the machine that prevents opening of the loading door in cases when the water level is unsuitable.

"Door Locked" symbol appears on the display when the loading door is locked.



**Opening the loading door in case of power failure:**



In case of power failure, you can use the loading door emergency handle under the pump filter cap to open the loading door manually.

- Turn off and unplug the appliance.
- Open the pump filter lid.

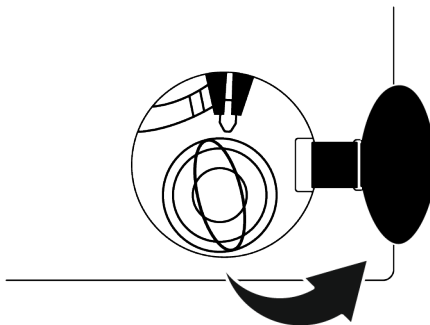

- Pull down the loading door emergency handle with a tool and release. Then open the loading door.
- If the loading door does not open then repeat the previous step.

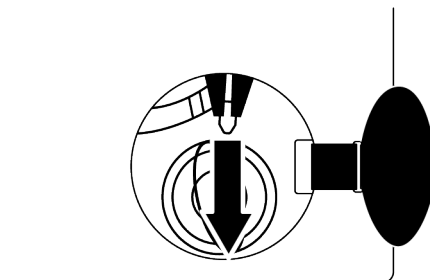

## 6.12 Changing the Selections After Programme has Started

**Adding laundry after the programme has started:**

If the water level in the machine is suitable when you press Start/Pause button, the door lock will be deactivated and the door will open, allowing you to add garments. The door lock icon on the display goes off when the door lock is deactivated. After adding garments, close the door and press Start/Pause button once again to resume the washing cycle.

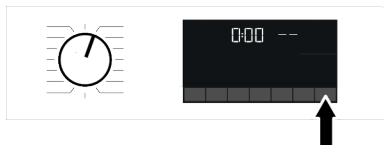

If the water level in the machine is not suitable when you press Start/Pause button, the door lock cannot be deactivated and the door lock icon on the display remains on.

**i** If the temperature of the water inside the machine is above 50°C, you cannot deactivate the door lock for safety reasons, even if the water level is suitable.

**Switching the machine to pause mode:**  
Press the Start/Pause button to switch the machine to pause mode. Pause symbol will flash on the display.

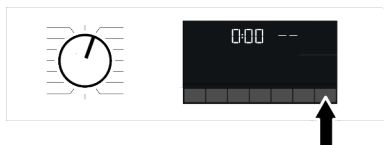

**Changing the programme selection after programme has started:**

The programme change is allowed when the current programme is running unless the Child Lock is enabled. This action will cancel the current programme.

**i** The selected programme starts anew.

**Changing the auxiliary function, speed and temperature:**

Depending on the step the programme has reached, you can cancel or activate the auxiliary functions. See "Auxiliary function selection"

## 7 Maintenance and Cleaning

**i** Please read the "Safety Instructions" section first!

You can also change the speed and temperature settings. See "Spin speed selection" and "Temperature selection".

**i** The loading door will not open if the water temperature in the machine is high or the water level is above the loading door baseline.

### 6.13 Cancelling the Programme

The programme is cancelled when programme selection knob is turned to a different programme or machine is turned off and on again using the programme selection knob.

**i** If you turn the programme selection knob when the Child Lock is enabled, the programme will not be cancelled. You should cancel the Child Lock first.

If you want to open the loading door after you have cancelled the programme but if it is not possible to open the loading door since the water level in the machine is above the loading door baseline, then turn the Programme Selection knob to Pump+Spin programme and drain the water in the machine.

### 6.14 End of Programme

End symbol appears on the display when the programme is completed.

If you do not press any button for 10 minutes, the machine will switch to OFF mode. Display and all indicators are turned off.

Completed programme steps will be displayed if you press On/Off button.

Service life of your product extends and frequently experienced problems will be reduced if it is cleaned at regular intervals.

## 7.1 Cleaning the Detergent Drawer

Clean the detergent drawer at regular intervals (once every 4 to 5 wash) as mentioned below to prevent accumulation of powder detergent.

Clean the syphon if excess amounts of water and fabric softener mixture remains in the softener compartment.

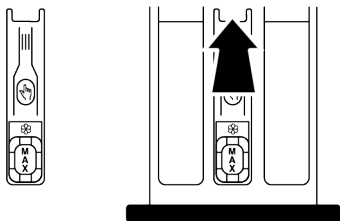

- Press the marked part of the syphon within the softener compartment and then pull the drawer towards yourself to take it out.
- Lift and remove the syphon from behind as shown.
- Rinse drawer and syphon in the sink with plenty of warm water. Use gloves or suitable brush to prevent contact of residues in the drawer with your skin.
- Firmly fit the syphon and the drawer back after cleaning.

## 7.2 Cleaning the Loading Door and the Drum

For products with drum cleaning programme, please see the Operating the product section.

 Repeat Drum Cleaning process in every 2 months.  
**NOTICE:** Use an anti-limescale suitable for the washing machines.

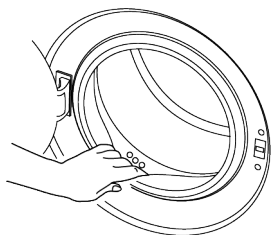

After every washing make sure that no foreign substance is left in the product.

If the holes on the door gasket shown in the figure is blocked, open the holes using a toothpick.

Foreign metal substances will cause rust stains in the drum. Clean the stains on the drum surface by using cleaning agents for stainless steel.

Never use steel wool or wire wool. These will damage the painted, chrome coated and plastic surfaces.

We recommend you to wipe the door gasket with a dry and clean cloth at the end of the programme. This will remove residues on the door gasket in your machine and prevent formation of malodours.

## 7.3 Cleaning the Body and Control Panel

Wipe the body of the product with soapy water or non-corrosive mild gel detergents as necessary, and dry with a soft cloth.

Use only a soft and damp cloth to clean the control panel. Do not use cleaning products that contain bleach

## 7.4 Cleaning the Water Intake Filters

There is a filter at the end of each water intake valve at the rear of the product and also at the end of each water intake hose where they are connected to the tap. These filters prevent foreign substances and dirt in the water to enter the product. Filters should be cleaned if they are dirty.

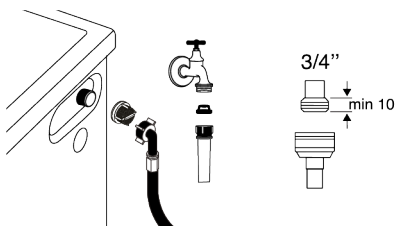

- Close the taps.
- Remove the nuts of the water intake hoses to access the filters on the water intake valves and clean them with an

appropriate brush. If the filters are too dirty, remove them from their places with a pliers and clean in this way.

- c. Take out the filters on the flat ends of the water intake hoses together with the gaskets and clean thoroughly under running water.
- d. Replace the gaskets and filters carefully and tighten their nuts by hand.

## 7.5 Draining Remaining Water and Cleaning the Pump Filter

The filter system in your product prevents solid items such as buttons, coins and fabric fibres clogging the pump impeller during draining of washing water. Thus, the water will be drained without any problem and the service life of the pump will extend.

If the product fails to drain water inside it, the pump filter is clogged. Filter must be cleaned whenever it is clogged or in every 3 months. Water must be drained off first to clean the pump filter.

In addition, prior to transporting the product (e.g., when moving to another house) water should be drained completely.



### NOTICE:

Foreign substances left in the pump filter may damage your product or may cause noise problem.

In regions where freezing is possible, the tap must be closed, system hose must be removed and the water inside the product must be drained when the product is not in use.

After each use, turn off the tap to which the mains hose is connected.

### In order to clean the dirty filter and drain the water:

- a. Unplug the product to cut off the supply power.



Temperature of the water inside the product may rise up to 90 °C. To avoid the risk of scalding, clean the filter after the water inside the product is cooled down.

- b. Open the filter cover.

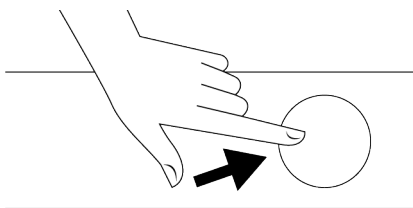

- c. Follow the below procedures in order to drain water.

### If the product does not have an emergency water draining hose, in order to drain the water:

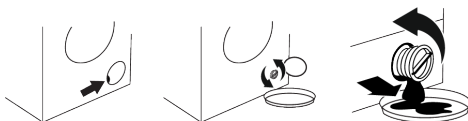

- Place a large container at the end of the hose to collect the water from the filter.
  - When the pump filter starts leaking water loosen it by turning (opposite clockwise). Fill the running water to the container you placed in front of the filter. Keep a cloth ready to clean the water that may spill.
  - Completely turn and remove the pump filter when the water in the product leaks out.
- a. Clean any residues inside the filter as well as fibres, if any, around the pump impeller region.
  - b. Replace the filter.
  - c. If the filter cap is composed of two pieces, close the filter cap by pressing on the tab. If it is one piece, seat the tabs in the lower part into their places first, and then press the upper part to close.



## 8 Troubleshooting



Please read the "Safety Instructions" section first!

### **Programmes do not start after the loading door is closed.**

- Start / Pause / Cancel button is not pressed. >>> Press Start / Pause / Cancel button.
- It may be difficult to close the loading door in case of excessive loading. >>> Reduce the amount of laundry and make sure that the loading door is closed properly.

### **Programme cannot be started or selected.**

- The product has switched to self-protection mode due to a supply problem (line voltage, water pressure, etc.). >>> Depending on the product model, select another program by turning the Program Selection button or pressing and holding the On/Off button for 3 seconds to cancel the program. Previous programme will be cancelled. See Cancelling the Programme [▶ 30]

### **Water inside the product.**

- Some water has remained in the product due to the quality control processes in the production. >>> This is not a failure; water is not harmful to the product.

### **The product does not take water in.**

- Tap is turned off. >>> Turn on the taps.
- Water inlet hose is bent. >>> Flatten the hose.
- Water inlet filter is clogged. >>> Clean the filter.
- Loading door is not closed. >>> Close the door.

### **The product does not drain water.**

- Water drain hose is clogged or twisted. >>> Clean or flatten the hose.
- Pump filter is clogged. >>> Clean the pump filter.

### **Product vibrates or makes noise.**

- Product is standing unbalanced. >>> Adjust the stands to balance the product.

- A hard substance has entered into the pump filter. >>> Clean the pump filter.
- Transportation safety bolts are not removed. >>> Remove the transportation safety bolts.
- Laundry quantity in the product is too little. >>> Add more laundry to the product.
- Excessive laundry is loaded in the product. >>> Take out some of the laundry from the product or distribute the load by hand to balance it homogeneously in the product.
- Product is leaning on a rigid item. >>> Make sure that the product is not leaning on anything.

### **There is water leaking from the bottom of the product.**

- Water drain hose is clogged or twisted. >>> Clean or flatten the hose.
- Pump filter is clogged. >>> Clean the pump filter.

### **Product stopped shortly after the programme started.**

- Machine has stopped temporarily due to low voltage. >>> Product will resume running when the voltage restores to the normal level.

### **Product directly drains the water it takes in.**

- Draining hose is not at adequate height. >>> Connect the water draining hose as described in the user manual.

### **No water can be seen in the product during washing.**

- Water is inside the invisible part of the product. >>> This is not a failure.

### **Loading door cannot be opened.**

- Loading door lock is activated because of the water level in the product. >>> Drain the water by running the Pump or Spin programme.
- Product is heating up the water or it is at the spinning cycle. >>> Wait until the programme completes.

- Loading door may be stuck because of the pressure it is subjected to. >>> Grab the handle and push and pull the loading door to release and open it.
- If there is no power, loading door of the product will not open. >>> To open the loading door, open the pump filter cap and pull down the emergency handle positioned at the rear side of the said cap. See Loading Door Lock [▶ 29]

### **Washing takes longer than specified in the user manual. (\*)**

- Water pressure is low. >>> Product waits until taking in adequate amount of water to prevent poor washing quality due to the decreased amount of water. Therefore, the washing time extends.
- Voltage is low. >>> Washing time is prolonged to avoid poor washing results when the supply voltage is low.
- Input temperature of water is low. >>> Required time to heat up the water extends in cold seasons. Also, washing time can be lengthened to avoid poor washing results.
- Number of rinses and/or amount of rinsing water have increased. >>> Product increases the amount of rinsing water when good rinsing is needed and adds an extra rinsing step if necessary.
- Excessive foam has occurred and automatic foam absorption system has been activated due to too much detergent usage. >>> Use recommended amount of detergent.

### **Programme duration does not count-down. (On models with display) (\*)**

- Timer may stop during water intake. >>> Timer indicator will not countdown until the product takes in adequate amount of water. The product will wait until there is sufficient amount of water to avoid poor washing results due to lack of water. Timer indicator will resume countdown after this.
- Timer may stop during heating step. >>> Timer indicator will not countdown until the product reaches the selected temperature.

- Timer may stop during spinning step. >>> Automatic unbalanced load detection system is activated due to the unbalanced distribution of the laundry in the product.

### **Programme duration does not count-down. (\*)**

- There is unbalanced load in the product. >>> Automatic unbalanced load detection system is activated due to the unbalanced distribution of the laundry in the product.

### **Product does not switch to spinning step. (\*)**

- There is unbalanced load in the product. >>> Automatic unbalanced load detection system is activated due to the unbalanced distribution of the laundry in the product.
- The product will not spin if water is not drained completely. >>> Check the filter and the draining hose.
- Excessive foam has occurred and automatic foam absorption system has been activated due to too much detergent usage. >>> Use recommended amount of detergent.

### **Washing performance is poor: Laundry turns gray. (\*\*)**

- Insufficient amount of detergent has been used over a long period of time. >>> Use the recommended amount of detergent appropriate for water hardness and the laundry.
- Washing has been made at low temperatures for a long time. >>> Select the proper temperature for the laundry to be washed.
- Insufficient amount of detergent is used with hard water. >>> Using insufficient amount of detergent with hard water causes the soil to stick on the cloth and this turns the cloth into gray in time. It is difficult to eliminate graying once it happens. Use the recommended amount of detergent appropriate for water hardness and the laundry.

- Excessive amount of detergent is used. >>> Use the recommended amount of detergent appropriate for water hardness and the laundry.

**Washing performance is poor: Stains persist or the laundry is not whitened. (\*\*)**

- Insufficient amount of detergent is used. >>> Use the recommended amount of detergent appropriate for water hardness and the laundry.
- Excessive laundry is loaded in. >>> Do not load the product in excess. Load with amounts recommended in the "Programme and consumption table".
- Wrong programme and temperature were selected. >>> Select the proper programme and temperature for the laundry to be washed.
- Wrong type of detergent is used. >>> Use original detergent appropriate for the product.
- Excessive amount of detergent is used. >>> Put the detergent in the correct compartment. Do not mix the bleaching agent and the detergent with each other.

**Washing performance is poor: Oily stains appeared on the laundry. (\*\*)**

- Regular drum cleaning is not applied. >>> Clean the drum regularly. For this procedure, see Cleaning the Loading Door and the Drum [► 31]

**Washing performance is poor: Clothes smell unpleasantly. (\*\*)**

- Odours and bacteria layers are formed on the drum as a result of continuous washing at lower temperatures and/or in short programmes. >>> Leave the detergent drawer as well as the loading door of the product ajar after each washing. Thus, a humid environment favourable for bacteria cannot occur in the machine

**Colour of the clothes faded. (\*\*)**

- Excessive laundry was loaded in. >>> Do not load the product in excess.
- Detergent in use is damp. >>> Keep detergents closed in an environment free of humidity and do not expose them to excessive temperatures.

- A higher temperature was selected. >>> Select the proper programme and temperature according to the type and soiling degree of the laundry.

**Washing machine does not rinse well.**

- The amount, brand and storage conditions of the detergent used are inappropriate. >>> Use a detergent appropriate for the washing machine and your laundry. Keep detergents closed in an environment free of humidity and do not expose them to excessive temperatures.
- Detergent was put in the wrong compartment. >>> If detergent is put in the pre-wash compartment although prewash cycle is not selected, the product can take this detergent during rinsing or softener step. Put the detergent in the correct compartment.
- Pump filter is clogged. >>> Check the filter.
- Draining hose is folded. >>> Check the drain hose.

**Laundry became stiff after washing. (\*\*)**

- Insufficient amount of detergent is used. >>> Using insufficient amount of detergent for the water hardness can cause the laundry to become stiff in time. Use appropriate amount of detergent according to the water hardness.
- Detergent was put in the wrong compartment. >>> If detergent is put in the pre-wash compartment although prewash cycle is not selected, the product can take this detergent during rinsing or softener step. Put the detergent in the correct compartment.
- Detergent was mixed with the softener. >>> Do not mix the softener with detergent. Wash and clean the drawer with hot water.

**Laundry does not smell like the softener. (\*\*)**

- Detergent was put in the wrong compartment. >>> If detergent is put in the pre-wash compartment although prewash cycle is not selected product, the can take this detergent during rinsing or

softener step. Wash and clean the drawer with hot water. Put the detergent in the correct compartment.

- Detergent was mixed with the softener. >>> Do not mix the softener with detergent. Wash and clean the drawer with hot water.

#### **Detergent residue in the detergent drawer. (\*\*)**

- Detergent was put in wet drawer. >>> Dry the detergent drawer before putting in detergent.
- Detergent has gotten damp. >>> Keep detergents closed in an environment free of humidity and do not expose them to excessive temperatures.
- Water pressure is low. >>> Check the water pressure.
- The detergent in the main wash compartment got wet while taking in the prewash water. Holes of the detergent compartment are blocked. >>> Check the holes and clean if they are clogged.
- There is a problem with the detergent drawer valves. >>> Call the Authorised Service Agent.
- Detergent was mixed with the softener. >>> Do not mix the softener with detergent. Wash and clean the drawer with hot water.
- Regular drum cleaning is not applied. >>> Clean the drum regularly. For this procedure, see *Cleaning the Loading Door and the Drum* ► 31]

#### **Too much foam forms inside the product. (\*\*)**

- Improper detergents for the washing machine is used. >>> Use detergents appropriate for the washing machine.
- Excessive amount of detergent is used. >>> Use only sufficient amount of detergent.
- Detergent was stored under improper conditions. >>> Store detergent in a closed and dry location. Do not store in excessively hot places.

- Some meshed laundry such as tulle may foam too much because of their texture. >>> Use smaller amounts of detergent for this type of item.
- Detergent was put in the wrong compartment. >>> Make sure you place the detergent in the appropriate compartment.
- Softener is being taken early by the product. >>> There may be problem in the valves or in the detergent drawer. Call the Authorised Service Agent.

#### **Foam is overflowing from the detergent drawer.**

- Too much detergent is used. >>> Mix 1 tablespoonful softener and ½ l water and pour into the main wash compartment of the detergent drawer. >>> Put detergent into the product suitable for the programmes and maximum loads indicated in the "Programme and consumption table". When you use additional chemicals (stain removers, bleaches and etc.), reduce the amount of detergent.

#### **Laundry remains wet at the end of the programme. (\*)**

- Excessive foam has occurred and automatic foam absorption system has been activated due to too much detergent usage. >>> Use recommended amount of detergent.
- (\*) The product does not switch to spinning step when the laundry is not evenly distributed in the drum to prevent any damage to the product and to its surrounding environment. Laundry should be rearranged and re-spun.

(\*\*) Regular drum cleaning is not applied. Clean the drum regularly. See *Cleaning the Loading Door and the Drum* ► 31]



If you cannot eliminate the problem although you follow the instructions in this section, consult your dealer or the Authorised Service Agent. Never try to repair a nonfunctional product yourself.



## 9 DISCLAIMER / WARNING

---

Some (simple) failures can be adequately handled by the end-user without any safety issue or unsafe use arising, provided that they are carried out within the limits and in accordance with the following instructions. (See the "Self-Repair" section.)

Therefore, except for the parts mentioned in the "Self-Repair" section that can be repaired by end users, repair by an authorized service station is strictly recommended in order to avoid safety problems and is mandatory for the Beko product warranty to continue.

### SELF-REPAIR

Self-repair can be done by the end-user with regard to the following spare parts: door, door hinge and seals, other seals, door locking assembly and plastic peripherals such as detergent dispensers (an updated list of spare parts is also available in <https://www.beko.com.tr/destek> as of 1st of March 2021).

Moreover, to ensure product safety and to prevent risk of serious injury, the mentioned self-repair shall be done following the instructions in the user manual for self-repair or which are available in <https://www.beko.com.tr/destek>. For your safety, unplug the product before attempting any self-repair.

Cannot be held responsible for safety problems that may occur due to repair operations or attempts applied by end users to parts other than those in the current parts list that are not made in accordance with the instructions specified in the user manuals or at <https://www.beko.com.tr/destek> address and that are not included in the current parts <https://www.beko.com.tr/destek> Beko In such a case, the Beko product warranty will be void.

Therefore, it is highly recommended that end-users refrain from the attempt to carry out repairs falling outside the mentioned list of spare parts, contacting in such cases authorized service stations. Such attempts by end-users may cause safety issues and

damage the product and subsequently cause fire, flood, electrocution and serious personal injury to occur.

By way of example, but not limited to, the repair of following parts must be made by authorized service stations: Motor, Pump, Main board, Motor board, Display board, etc.

The manufacturer/seller cannot be held liable in any case where end-users do not comply with the conditions stated above.



