



Dryer
User Manual



KT 700



EN

2960313351_EN/120422.1234

Please read this user manual first!

Dear Customer,
Thank you for preferring a Arçelik product. We hope that your product which has been manufactured with high quality and technology will give you the best results. We advise you to read through this manual and the other accompanying documentation carefully before using your product and keep it for future reference. If you transfer the product to someone else, give its manual as well. Pay attention to all details and warnings specified in the user manual and follow the instructions given therein.
Use this user manual for the model indicated on the cover page.

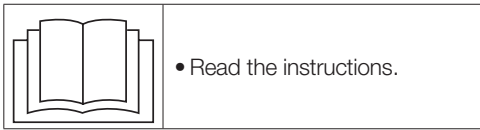

Explanation of symbols

Throughout this user manual the following symbols are used:

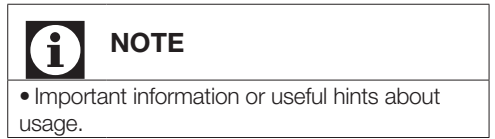
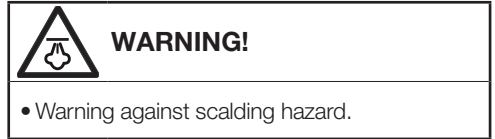
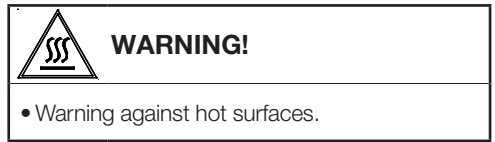
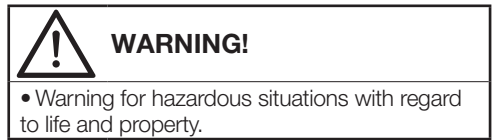
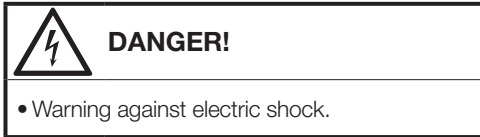

Do not dispose of the packaging wastes with the domestic waste or other wastes, discard them to the dedicated collection points designated by the local authorities.



.This product was manufactured using the latest technology in environmentally friendly conditions

1 Important instructions for safety and environment



NOTE

- This section contains safety instructions that will help protect from risk of personal injury or property damage. Failure to follow these instructions shall void any warranty.

1.1 General safety



WARNING!

The dryer can be used by children at and above 8 years old and by persons whose physical, sensory or mental capabilities were not fully developed or who lack experience and knowledge provided that they are supervised or trained on the safe usage of the product and the risks it brings out. Children should not play with the product. Cleaning and maintenance works should not be performed by children unless they are supervised by someone. Children of less than 3 years should be kept away unless continuously supervised.

- Adjustable feet should not be removed. The gap between the dryer and the floor should not be reduced with materials such as carpet, wood and tape. This will cause problems with the dryer.



WARNING!

Always have the installation and repairing procedures carried out by the Authorized Service. Manufacturer shall not be held liable for damages that may arise from procedures carried out by unauthorized persons.

- Never wash the dryer by spraying or pouring water onto it! There is the risk of electric shock!

For the products with a steam function:



WARNING!

- Use only distilled water or water condensed in the water tank of the machine in steam programs. Do not use mains water or additives. When using condensed water in the water tank, it should be filtered and cleared of fibres.
- Do not open the door when steam programs are running. Hot water may be expelled.
- Before putting laundry in a steam program, stains on it should be removed.
- You may only put laundry that is not dirty or stained but permeated with unpleasant odour in steam (odour removal) program.
- Do not use any dry cleaning sets or additional materials in a steam program or in any program.

1.1.1 Electrical safety



DANGER!

- Electrical safety instructions should be followed while electrical connection is made during the installation.
- The appliance must not be supplied through an external switching device, such as a timer, or connected to a circuit that is regularly switched on and off by utility.
- Connect the dryer to a grounded outlet protected by a fuse at the value specified on the type label. Have the grounding installation performed by a qualified electrician. Our company shall not be liable for any damages that will arise when the dryer is used without grounding in accordance with the local regulations.
- The voltage and allowed fuse protection is stated on the type label plate.
- The voltage specified on the type label must be equal to your mains voltage.
- Unplug the dryer when it is not in use.
- Unplug the dryer from the mains during installation, maintenance, cleaning and repair works.
- Do not touch the plug with wet hands! Never unplug by pulling on the cable, always pull out by grabbing the plug.



DANGER!

- Do not use extension cords, multi-plugs or adaptors to connect the dryer to power supply in order to decrease the risk of fire and electric shock.
- Power cable plug must be easily accessible after installation.
- Damaged mains cable should be changed notifying the Authorized Service.
- If the dryer is faulty, it must not be operated unless it is repaired by an authorized service agent! There is the risk of electric shock!

1.1.2 Product safety



DANGER!

- Superheating of the clothes inside of the dryer can occur if you cancel the programme or in the event of a power failure whilst the dryer is running, this concentration of heat can cause self-combustion and fire so always activate the ventilation programme to cool down or quickly remove all laundry from the dryer in order to hang them up and dissipate the heat.



DANGER!

Points to be taken into

consideration for fire hazard:

Below specified laundry or items must not be dried in the dryer considering fire hazard.

- Unwashed laundry items
- Items soiled with oil, acetone, alcohol, fuel oil, kerosene, stain removers, turpentine, paraffin or paraffin removers must be washed in hot water with plenty of detergent before being dried in the dryer.

For this reason especially the items containing the above specified stains must be washed very well, to do this use adequate detergent and choose a high washing temperature.

Below specified laundry or items must not be dried in the dryer due to the fire hazard:

- Garments or pillows bolstered with rubber foam (latex foam), shower bonnets, water resistant textiles, materials with rubber reinforcement and rubber foam pads.

Clothing cleaned with industrial chemicals.

Items such as lighter, match, coins, metal parts, needle etc. may damage the drum set or may lead to functional problems. Therefore check all the laundry that you will load into your dryer.



DANGER!

- Never stop your dryer before the programme completes. If you must do this, remove all laundry quickly and lay them out to dissipate the heat.
- Clothes that are washed inadequately may ignite on their own and even may ignite after drying ends.
- You must provide enough ventilation in order to prevent gases exiting from devices operating with other types of fuels including the naked flame from accumulating in the room due to the back fire effect.



WARNING!

- Underwear that contains metal reinforcements should not be dried in the dryer. Dryer may be damaged if metal reinforcements come loose and break off during drying.



NOTE

- Use softeners and similar products in accordance with the instructions of their manufacturers. Always clean the lint filter before or after each loading. Never operate the dryer without the lint filter installed.



WARNING!

- Never attempt to repair the dryer by yourself. Do not perform any repair or replacement procedures on the product even if you know or have the ability to perform the required procedure unless it is clearly suggested in the operating instructions or the published service manual. Otherwise, you will be putting your life and others' lives in danger.
- There must not be a lockable, sliding or hinged door that may block the opening of the loading door in the place where your dryer is to be installed.
- Install your dryer at places suitable for home use. (Bathroom, closed balcony, garage etc.)
- Make sure that pets do not enter the dryer. Check the inside of the dryer before operating it.
- Do not lean on the loading door of your dryer when it is open, otherwise it may fall over.
- The lint must not be allowed to accumulate around the tumble dryer
- The tumble dryer is not to be used if industrial chemicals have been used for cleaning.
- Fabric softeners, or similar products, should be used as specified by the fabric softener instructions.
- Exhaust air must not be discharged into a flue which is used for exhausting fumes from appliances burning gas or other fuels.

1.2 Mounting over a washing machine

- A fixing device should be used between the two machines when installing the dryer above a washing machine. The fitting device must be installed by the authorized service agent.
- Total weight of the washing machine and the dryer -with full load- when they are placed on top of each other reaches to approx. 180 kilograms. Place the products on a solid floor that has sufficient load carrying capacity!



WARNING!

- Washing machine cannot be placed on the dryer. Pay attention to the above warnings during the installation on your washing machine.

Installation Table for Washing Machine and Dryer

Dryer Depth	Washing Machine Depth			
	62 cm	60 cm	54 cm	< 50 cm
54 cm	Can be installed		Cannot be installed	
60 cm	Can be installed	Cannot be installed		

1.3 Intended use

- Dryer has been designed for domestic use. It is not suitable for commercial use and it must not be used out of its intended use.
- Use the dryer only for drying laundry that are marked accordingly.
- The manufacturer waives any responsibility arisen from incorrect usage or transportation.
- The service life of the dryer that you purchased is 10 years. During this period, original spare parts will be available to operate the dryer properly.

1.4 Child safety

- Packaging materials are dangerous for the children. Keep packaging materials away from children.
- Electrical products are dangerous for the children. Keep children away from the product when it is operating. Do not let them tamper with the dryer. Use the child-proof lock in order to prevent the children to tamper with the dryer.

 NOTE
Child-proof lock is on the control panel. (See Child lock)

- Keep loading door closed even when the dryer is not in use.

1.5 Compliance with the WEEE Directive and Disposing of the Waste Product:



This product complies with EU WEEE Directive (2012/19/EU). This product bears a classification symbol for waste electrical and electronic equipment (WEEE).

This symbol indicates that this product shall not be disposed with other household wastes at the end of its service life. Used device must be returned to official collection point for recycling of electrical and electronic devices. To find these collection systems please contact to your local authorities or retailer where the product was purchased. Each household performs important role in recovering and recycling of old appliance. Appropriate disposal of used appliance helps prevent potential negative consequences for the environment and human health.

1.6 Compliance with RoHS Directive

The product you have purchased complies with EU RoHS Directive (2011/65/EU). It does not contain harmful and prohibited materials specified in the Directive.

1.7 Package information

Packaging materials of the product are manufactured from recyclable materials in accordance with our National Environment Regulations. Do not dispose of the packaging materials together with the domestic or other wastes. Take them to the packaging material collection points designated by the local authorities.

1.8 Technical Specifications

EN

Height (Min. / Max.)	84,6 cm / 86,6 cm*
Width	59,7 cm
Depth	56,8 cm
Capacity (max.)	7 kg**
Net weight (\pm %10)	34,5 kg
Voltage	See type label***
Rated power input	
Model code	

* Min. height: Height with adjustable feet are closed.

Max. height: Height with adjustable feet are opened maximum.

** Dry laundry weight before washing.

*** Type label is located behind the loading door.

 NOTE
<ul style="list-style-type: none">• Technical specifications of the dryer are subject to specification without notice to improve the quality of the product.• Figures in this manual are schematic and may not match the product exactly.• Values stated on markers on the dryer or in the other published documentation accompanying with the dryer are obtained in laboratory in accordance with the relevant standards. Depending on operational and environmental conditions of the dryer, these values may vary.





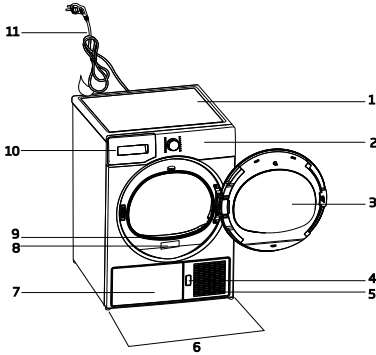

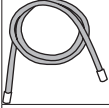

2 Your Dryer

2.1 Overview

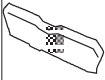

1. Top panel
2. Control panel
3. Loading door
4. Kick plate opening button
5. Ventilation grids
6. Adjustable legs
7. In models where the tank is placed below, the water tank is inside the toe board
8. Type label
9. Lint filter
10. Water tank drawer (in models where the tank is placed above)
11. Power cord

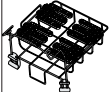
2.2 Package Contents

	1. Water drain hose *		5. Drying basket user manual*
	2. Filter drawer spare sponge*		6. Water Filling Container*
	3. User Manual		7. Pure Water*
	4. Drying basket*		8. Fragrance Capsules Group*

*Optional - may not be included, depends on model.

3 Installation

Before the calling the nearest Authorized Service for the installation of the dryer, ensure that electrical installation and water drain is appropriate referring to the user's manual. If they are not suitable, contact a qualified electrician and technician to make necessary arrangements.



NOTE

- Preparation of the dryer's location as well as the electrical and waste water installations is under customer's responsibility.



WARNING!

- Prior to installation, visually check if the dryer has any defects on it. If the drier is damaged, do not have it installed. Damaged products cause risks for your safety.

3.1 Appropriate installation location

Install the dryer on a stable and level surface. Dryer is heavy. Do not move it by yourself.

- Operate your dryer in a well ventilated, dust-free environment.
- The gap between the dryer and the surface should not be reduced by the materials such as carpet, wood and tape.
- Do not cover the ventilation grills of the dryer.
- There must not be a lockable, sliding or hinged door that may block the opening of the loading door in the place where your dryer is to be installed.
- Once the dryer is installed, it should stay at the same place where its connections have been made. When installing the dryer, make sure that its rear wall does not touch anywhere (tap, socket, etc.).
- Place the dryer at least 1 cm away from the edges of other furniture.
- Your dryer can be operated at temperatures between +5°C and +35°C. If the operating conditions fall outside of this range, operation of the dryer will be adversely affected and it can get damaged.

- The rear surface of the tumble dryer shall be placed against a wall.

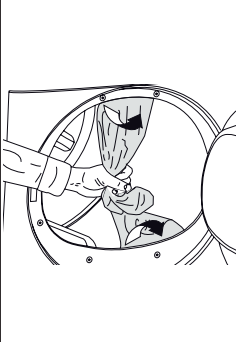

	DANGER!
<ul style="list-style-type: none"> • Do not place the dryer on the power cable. 	

3.2 Removing the transportation safety assembly

	WARNING!
	<ul style="list-style-type: none"> • Remove the transportation safety assembly before using the dryer for the first time. • If the door swing side of your appliance can be modified, see the reversible door mounting instructions.

3.3 Connecting to the drain

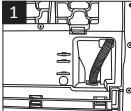
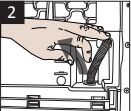
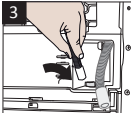
You can directly drain accumulated water through the water drain hose supplied with the product instead of periodically draining the water collected in the water tank.

		1-2 Pull hose at the behind of the dryer by hand in order to disconnect it from where it is connected. Do not use any tools to remove the hose.
		
3 Connect one end of the drain hose supplied with the dryer to the connection point from where you removed the hose of the product in previous step.		
4 Connect the other end of the drain hose directly to the wastewater drain or to the washbasin.		

	NOTE
<ul style="list-style-type: none"> • Water drain hose should be attached to a height of maximum 80 cm. • Make sure that the water drain hose is not stepped on and it is not folded between the drain and the machine. • If there is an accessories pack supplied with your product, please see the detailed description. 	

3.4 Adjusting the feet

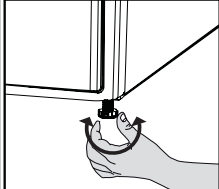
	Turn the feet to left or right until the dryer stands level and firmly.
---	---

3.5 Transportation of the dryer

Drain all water that has remained in the dryer. If direct water drain connection is made, then remove the hose connections.

	WARNING!
<ul style="list-style-type: none"> • We recommend carrying the dryer in upright position. If it is not possible to carry the machine in the upright position, we recommend carrying it by tilting towards the right side when looked from the front. 	

3.6 Changing the illumination lamp

In case an illumination lamp is used in your laundry dryer. To change the Bulb/LED used for illumination of your tumble dryer, call your Authorized Service. The lamp(s) used in this appliance is not suitable for household room illumination. The intended purpose of this lamp is to assist the user to place laundry in the tumble dryer in a comfortable way. The lamps used in this appliance have to withstand extreme physical conditions such as vibrations and temperatures above 50 °C

4 Preparation

4.1 Laundry suitable for drying in the dryer

Always obey the instructions given on the garment tags. Dry only the laundry having a label stating that they are suitable for drying in a dryer.

4.2 Laundry not suitable for drying in the dryer



Items with this symbol should not be dried in the dryer.

i	NOTE
<ul style="list-style-type: none"> Delicate embroidered fabrics, woollen, silk garments, delicate and valuable fabrics, airtight items and tulle curtains are not suitable for machine drying. 	

4.3 Preparing laundry for drying

- Laundry may be tangled with each other after washing. Separate the laundry items before placing them into the dryer.
- Dry garments having metal accessories such as zippers, inside out.
- Fasten the zippers, hooks and buckles and button sheets.

4.4 Things to be done for energy saving

- Spin your laundry at the highest speed possible when washing them. Thus, the drying time is shortened and energy consumption is reduced.
- Sort out the laundry depending on their type and thickness. Dry the same type of laundry together. For example thin kitchen towels and tableclothes dries earlier than thick bathroom towels.
- Follow the instructions in the user manual for programme selection.
- Do not open the loading door of the machine during drying unless necessary. If you must open the loading door, do not keep it open for a long time.
- Do not add wet laundry while the dryer is in operation

- For models with a condenser unit: clean the condenser once in a month or after every 30 operations regularly. .
- Clean the filter periodically. Read the Maintenance and cleaning of filters for detailed information.
- For models with flue unit: comply with the flue connection instructions and clean the flue.
- During the drying process, air the room well where your tumble dryer is operating.

4.5 Correct load capacity

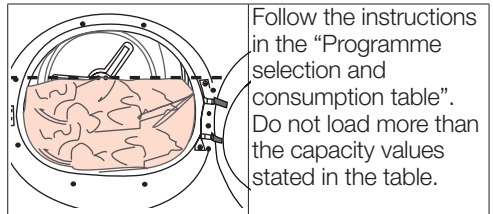

Following weights are given as examples.

Laundry	Approximate weights (g)*	Laundry	Approximate weights (g)*
Cotton quilt covers (double)	1500	Blouses	150
Cotton quilt covers (single)	1000	Cotton shirts	300
Bed sheets (double)	500	Shirts	250
Bed sheets (single)	350	Cotton dresses	500
Large tablecloths	700	Dresses	350
Small tablecloths	250	Jeans	700
Tea napkins	100	Handkerchiefs (10 pieces)	100
Bath towels	700	T-Shirts	125
Hand towels	350		

*Dry laundry weight before washing.

5 Operating the product

5.1 Control Panel

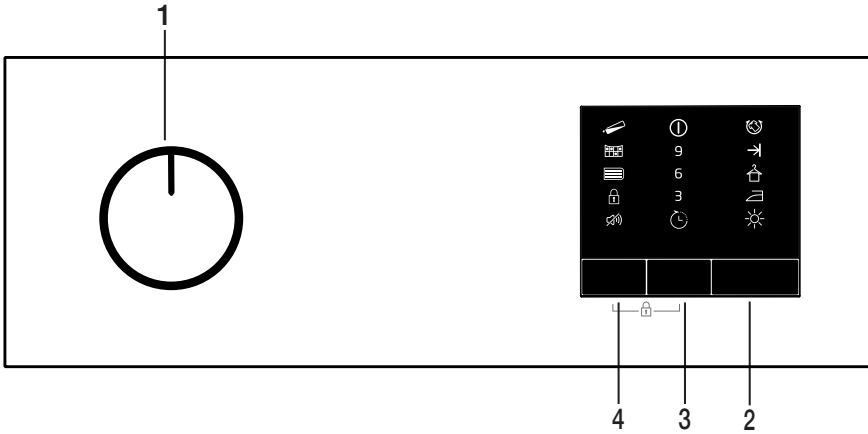

- 1. On/Off/Programme selection button
- 2. Start/Pause button

- 3. Time Delay button
- 4. Audio warning level button

5.2 Symbols

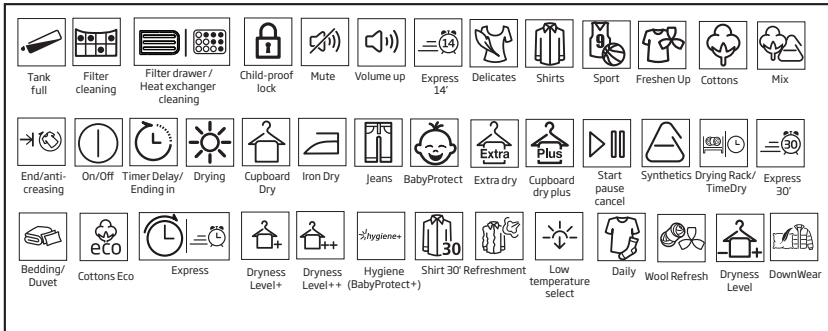

5.3 Preparation of drying machine

- Plug the drying machine.
- Open the loading door.
- Place the laundry to the drying machine without jamming them.
- Push and close the loading door.

Select the desired programme using the On/Off/Programme selection knob, the machine will turn on.

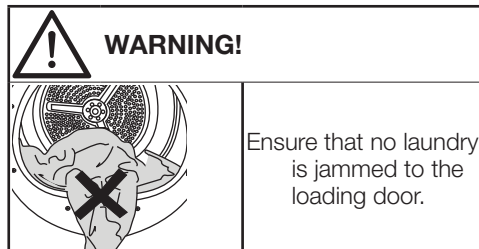

NOTE

- Selecting a programme using the On/Off/Programme selection button does not mean that the programme started. Press the Start / Stand-by button to start the programme.

5.4 Programme selection and consumption table

EN				
Programmes	Programme Description	Capacity (kg)	Spin speed in washing machine (rpm)	Drying Time (minutes)
Cottons Iron Dry	You may dry your cotton laundry to be ironed in this program to have them slightly damp for ease of ironing. (Shirt, T-shirt, tablecloth, etc.)	7	1000	90
Cottons Eco	You may dry all your cotton laundry in this program. (T-shirt, pants, pyjamas, baby clothes, underwear, linen, etc.) You can put your laundry in the wardrobe without ironing.	7	1000	121
Cottons Cupboard Dry	You may use this program for extra dryness in thick laundry such as pants, tracksuit. You can put your laundry in the wardrobe without ironing.	7	1000	126
Cottons Extra Dry	You may dry your thick cotton laundry in this program such as towels, bathrobe, etc. You can put your laundry in the wardrobe without ironing.	7	1000	131
Synthetics Iron Dry	You may dry your synthetic laundry to be ironed in this program to have them slightly damp for ease of ironing. (Shirt, T-shirt, tablecloth, etc.)	3,5	800	35
Synthetics Cupboard Dry	You may dry all your synthetic laundry in this program. (Shirt, T-shirt, underwear, tablecloth, etc.) You can put your laundry in the wardrobe without ironing.	3,5	800	48
Jeans	You may dry denim pants, skirts, shirts or jackets in this program.	4	1200	80
Cool Refresh	Ventilates for 10 minutes without blowing hot air. You can ventilate the cotton and linen clothes that have been enclosed for a long time with this program to remove their odour. You can use this program to ventilate and soften wool laundry that can be washed in a washing machine. Do not use for full drying.	-	-	10
Time Programmes	You may select from time programmes between 10 and 30 minutes to achieve the desired drying level at low temperature. In this programme, tumble drier's operation lasts for the set time independently from the dryness of laundry.	-	-	-
Outdoor/Sport	Use it to dry your clothes made of synthetics, cotton or mixed fabrics or waterproof products such as functional jacket, raincoat etc. Turn them inside out prior to drying.	2	1000	78
Mix/Daily	You can dry both cotton and synthetic laundry with this programme. Sports and fitness clothes may be dried with this program.	4	1000	83
Towels	It is a long-term program that you can use for the clothes (baby clothes, towels, underwear, etc. cotton) you require hygiene. Hygiene is provided with high temperature. It is especially suitable for durable fabrics. ((This program is identified and approved by England's "The British Foundation" (Allergy UK).))	5	800	105
GentleCare	It dries the shirts in a more sensitive manner, and causes less creasing and easier ironing.	1,5	1200	40
Super Short 0.5kg	Use this program to have 2 shirts ready for ironing.	0,5	1200	14

Energy consumption values				
Programmes	Capacity (kg)	Spin speed in washing machine (rpm)	Approximate amount of remaining humidity	Energy consumption value kWh
Cottons Eco *	7	1000	60%	4,21
Cottons Iron dry	7	1000	60%	3,25
Synthetics cupboard dry	3,5	800	40%	1,42
	"Cottons Eco programme" used at full and partial load is the standard drying programme to which the information in the label and the fiche relates, that this programme is suitable for drying normal wet Cottons laundry and that it is the most efficient programme in terms of energy consumption for Cottons.			

* : Energy Label standard programme (EN 61121:2012)

All the values on the chart are identified according to EN 61121:2012 standard. Consumption values may vary from the values in the chart depending on laundry type, wringing speed, ambient conditions and voltage levels.



Allergy UK is the brand of the British Allergy Association. Seal of Approval is created to guide people that require recommendation about a product that the related

product restricts / reduces / eliminates the allergens or reduces the allergen content significantly in the ambient where allergy patients exist. It aims to provide assurance that the products are tested scientifically or examined in a way to provide measurable results.

5.5 Auxiliary functions

Audible warning

Drying machine makes an audible warning when the programme is completed. If you don't want it to make an audible warning, press the "Buzzer" button. When you press the Buzzer button, a light will illuminate and no audible warning will be made when the programme ends.



NOTE

- You can select this function before or after the programme starts.

Time Delay

If you wish to dry your clothes at a later time, thanks to the time delay function, you can delay the program start up to 3 hours, 6 hours or 9 hours.

Open the loading door and put the laundry in. Select the drying program. Press the time delay button to set the desired delay time. When the time delay button is pressed once, a 3-hour delay is selected and the relevant indicator lights up. When the same button is pressed again, 6 hours; and if pressed once more, 9 hours delay will be selected.

If you press the time delay button again, delayed start will be cancelled. After selecting the delayed start, press the "Start/Pause" button to start the delayed start for the selected program.



NOTE

- Additional laundry may be loaded/taken out during the delayed start time. At the end of the time delay countdown, the warning symbol disappears and the drying process starts.

Changing the delay time

If you want to change the time during countdown, turn the on/off/programme selection knob to cancel the program. Select the desired program and repeat the delayed start process.

Cancelling the delayed start function

If you wish to cancel the delayed start countdown and start the program right away, rotate the on/off/programme selection knob to cancel the program. Select the desired program and press "Start/Pause".

5.6 Warning indicators



NOTE

- Warning indicators may vary depending on the model of your dryer.

Filter cleaning

When the programme is completed, the warning indicator for filter cleaning turns on.

Water tank

If the water tank fills up while the programme continues, the warning indicator starts flashing and the machine goes into stand-by. In this case, empty the water tank and start the programme by pressing the Start / Stand-by button. Warning indicator turns off and programme resumes.

Filter drawer /Heat exchanger cleaning

When the programme is finished, the cleaning symbol of the heat exchanger or filter drawer may light up.

5.7 Starting the programme

Press the Start/Stand-by button to start the programme.

Drying indicator will light up, indicating that the programme has started.

5.8 Child Lock

The drying machine has a child lock which prevents the programme flow from being interrupted when the buttons are pressed during a programme. When the child lock is activated, all buttons on the panel except the On/Off/Programme selection knob are deactivated.

Press the End Time and Buzzer buttons simultaneously for 3 buttons to activate the child lock.

The child lock has to be deactivated to be able to start a new programme after the current programme is finished or to be able to interfere with the programme. To deactivate the child lock, keep the same buttons pressed for 3 seconds.



NOTE

- When the child lock is activated, the child lock warning indicator on the screen turns on.
- Child lock deactivates when the drying machine is turned off and on by the On/Off/Cancel knob.

When the child lock is active:

When the drying machine runs, or in stand-by state, the indicator symbols won't change upon changing the position of the programme selection knob.



NOTE

- When the drying machine runs and the child lock is active, it beeps twice when the programme selection knob is turned. If the child lock is deactivated without returning the programme selection knob to its previous position, programme will terminate due to the change in the programme selection knob position.

5.9 Changing the programme after it is started

You can change the programme you selected to dry your laundry with a different programme after the drying machine starts running

- For instance, select Extra Dry programme by turning the On/Off/Programme selection knob to select Extra Dry instead of Iron Dry.
- Press the Start/Stand-by button to start the programme.

Adding and removing clothes during stand-by

If you want to add or remove clothes to/from the drying machine after the drying programme starts:

- Press the Start/Stand-by button to put the drying machine in Stand-by state. The drying operation stops.
- Open the loading door while in Stand-by state, and close the door after you remove or add laundry.
- Press the Start/Stand-by button to start the programme.



NOTE

- Adding laundry after the drying operation starts may cause the dried laundry inside the machine to mix with wet laundry and leave the laundry damp at the end of operation.
- Adding or removing laundry during drying may be repeated as many times as you wish. But this operation continuously interrupts the drying operation, and thus increases programme duration and energy consumption. So, it is recommended to add laundry before the programme starts.
- If a new programme is selected by turning the programme selection knob while the drying machine is in stand-by, the running programme terminates.

5.11 End of programme

When the program ends, the Last/Anti-Wrinkle and Fibre Filter Cleaning Warning LEDs on the program follow up indicator will illuminate. Loading door may be opened and the dryer machine becomes ready for another run. Bring the On/Off/Programme selection knob to On/Off position to turn the drying machine off.



NOTE

- If the laundry is not removed after the programme is completed, the wrinkle prevention function activates for 2 hours to prevent the laundry inside the machine to get wrinkled. The programme tumbles the laundry with 10-minute intervals to prevent them from wrinkling.



WARNING!

- Do not touch the inner surface of the drum while adding or removing clothes during a continuing programme. The drum surface is hot.

5.10 Cancelling the programme

If you want to cancel the programme and terminate the drying operation for any reason after the drying machine starts running, turn the On/Off/Cancel knob, the programme will be cancelled.



WARNING!

- The inside of the drying machine shall be extremely hot when you cancel the programme during machine operation, so run the refresh programme to allow it to cool down.

6 Maintenance and cleaning

Service life of the product extends and frequently faced problems decrease if cleaned at regular intervals.



DANGER!

This product must be unplugged during maintenance and cleaning works (control panel, body, etc.).

6.1 Lint Filter / Loading Door Inner Surface

Lint and fiber released from the laundry to the air during the drying cycle are collected in the Lint Filter.



WARNING!

- Always clean the lint filter and the inner surfaces of the loading door after each drying process.



NOTE

- You can clean the lint filter housing with a vacuum cleaner.

To clean the lint filter:

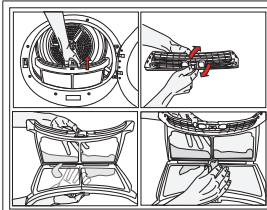

- Open the loading door.
- Remove the lint filter by pulling it up and open the lint filter.

- Clean lint, fiber, and cotton raveling by hand or with a soft piece of cloth.
- Close the lint filter and place it back into its housing.

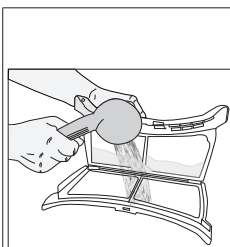

A layer can build up on the filter pores that can cause clogging of the filter after using the dryer for a while. Wash the lint filter with warm water to remove the layer that builds up on the lint filter surface. Dry the lint filter completely before reinstalling it.

- Clean the entire inner surface of the loading door and loading door gasket with a soft damp cloth.

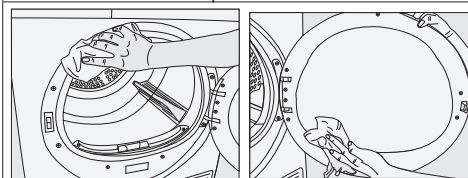

6.2 Cleaning the sensors

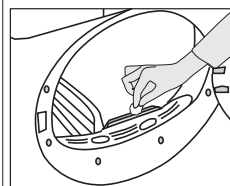

There are dampness sensors in the dryer that detect whether the laundry is dry or not. To clean the sensors:

- Open the loading door of the dryer.
- Allow the machine to cool down if it is still hot due to the drying process.
- Wipe the metal surfaces of the sensor with a soft cloth, dampened with vinegar and dry them.



NOTE

- Clean metal surfaces of the sensors 4 times a year.
- Do not use metal tools when cleaning metal surfaces of the sensors.

 **WARNING!**

- Never use solvents, cleaning agents or similar substances for cleaning due to the risk of fire and explosion!

6.3 Draining the water tank

Dampness of the laundry is removed and condensed during drying process and the water that arise accumulates in the water tank. Drain the water tank after each drying cycle.

 **WARNING!**

- Condensed water is not drinkable!
- Never remove the water tank when the program is running!

If you forget to drain the water tank, the machine will stop during the subsequent drying cycles when the water tank is full and the Water Tank warning symbol will flash. If this is the case, drain the water tank and press Start / Pause button to resume the drying cycle. To drain the water tank:

1. Remove the water tank in the drawer or container carefully.

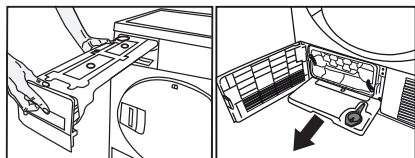

2. Drain the water in the tank.

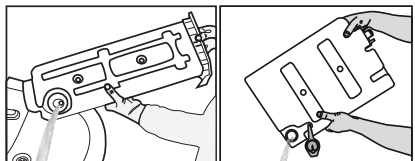

- If there is lint accumulation in the funnel of the water tank, clean it under running water.
- Place the water tank into its seat.

 **NOTE**

- If the direct water draining is used as an option, there is no need to empty the water tank.

6.4 For the condenser;

 **NOTE**

- Clean the condenser after every 30 drying cycles or once a month.

o clean the condenser:

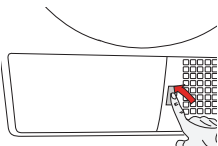

- If a drying process has been carried out, open the door of the machine and wait until it cools down

- Unlock the 2 condenser locks after opening the kick plate
- Pull out the condenser.

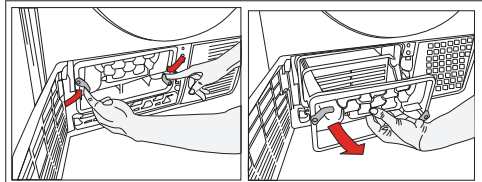

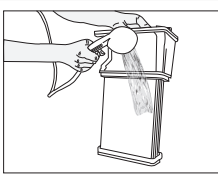

Clean the condenser by applying pressurized water with a shower armature and wait until the water drains.

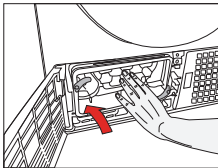

Place the condenser in its housing. Fasten the 2 locks and make sure that they are seated securely.

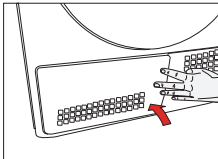

Close the kick plate cover.

7 Troubleshooting

Drying operation takes too long.

Fibre filter pores might be clogged. >>> Wash the filter with warm water.

Filter drawer might be clogged. >>> Clean the sponge and filter cloth (if any) in the filter drawer. (for the products with a heat pump)

The condenser might be blocked. >>> Wash the condenser.(for the products with a condenser)

The ventilation grills in front of the machine may be closed. >>> Remove any objects in front of the ventilation grills that blocks air.

Ventilation may be inadequate because the area the machine is installed in is too small. >>> Open the door or windows to prevent the room temperature from rising very high.

A lime layer may have accumulated on the humidity or temperature sensors. >>> Clean the humidity or temperature sensors.

Excessive amount of laundry might be loaded. >>> Do not load the drying machine excessively.

Laundry might not have been wrung adequately. >>>

Perform a higher speed wringing on the washing machine.

Clothes come out damp after drying.

A program not suitable for the laundry type may have been used.>>> Check the maintenance labels on the clothes and select a program suitable for the clothes' type or use time programs as extra.

Fibre filter pores might be clogged. >>> Wash the filter with warm water.

The condenser might be blocked. >>> Wash the condenser. (for the products with a condenser)

Filter drawer might be clogged. >>> Clean the sponge and filter cloth (if any) in the filter drawer.(For the products with a heat pump)

Excessive amount of laundry might be loaded. >>> Do not load the drying machine excessively.

Laundry might not have been wrung adequately. >>>

Perform a higher speed wringing on the washing machine.

Drying machine does not turn on or program cannot be started. Drying machine does not run after it is configured.

Power plug might be unplugged. >>> Make sure the power cord is plugged in.

Loading door might be open. >>> Ensure that the loading door is properly closed.

A program might not be set or Start/Stand-by button might not be pressed. >>> Check that the program is set and it is not in Stand-by position.

Child lock may be activated. >>> Turn off the child lock.

Program terminated prematurely for no reason.

Loading door might not be closed completely. >>> Ensure that the loading door is properly closed.

There might be a power outage. >>> Press the Start/Stand-by button to start the program.

Water tank may be full. >>> Empty the water tank.

Clothes have shrunk, hardened or spoiled.

A program not suitable with the laundry type might have been used. >>> Check the maintenance labels on the clothes and select a program suitable for the clothes.

The lighting inside the drying machine does not turn on.

(For models with a lamp)

Drying machine might not be turned on with the On/Off button or program might not be selected for machines without an On/Off button. >>> Make sure that the drying machine is turned on.

Lamp might be malfunctioning. >>> Contact Authorized Service to replace the lamp.

Filter cleaning warning symbol/LED is on/flashing.

Fibre filter might not be cleaned. >>> Clean the filter.

The filter slot might be clogged with lints. >>> Clean the filter slot.

A layer of fluff might have accumulated clogging up the lint filter pores. >>> Wash the filter with warm water.

The condenser might be blocked. >>> Wash the condenser.

Water drips from the loading door.

Fibres might have gathered on the inner sides of the loading door and the loading door gasket. >>> Clean the inner surfaces of the loading door and the loading door gasket surfaces.

Loading door opens by itself.

Loading door might not be closed completely. >>> Push the loading door until the closing sound is heard.

Water tank warning symbol / led is on/flashing.

Water tank may be full. >>> Empty the water tank.

Water discharge hose might have collapsed. >>> If the product is connected directly to the water drain check the water discharge hose.

Steam symbol is flashing.(For the products with a steam function)

Steam tank may be empty => Fill the steam tank with distilled or condensed water.

Steam programs do not start (For the products with a steam function)

Steam tank may be empty, steam tank warning icon may light up on the screen => Fill the steam tank until the steam icon goes off.

Wrinkles are not removed with wrinkle removing program. (For the products with a steam function)

Excess amount of laundry may have been placed =>

Place specified amount of laundry.

Steam application time may be selected in low level =>

Choose a program with high amount of steam.

After completion of the program, the laundry may have stayed in the machine for a long time => Take the laundry out as soon as the program finishes, and hang it out.

Laundry odour not lessened with the odour removal program.(For the products with an odour removal program)

Excess amount of laundry may have been placed =>

Place specified amount of laundry.

Steam application time may be selected in low level =>

Choose a program with high amount of steam.



WARNING!

- If the problem persists after following the instructions in this section, contact your vendor or an Authorized Service. Never try to repair your product yourself.



NOTE

- In an event that you encounter an issue on any part on your appliance, you can ask for a replacement by contacting the authorized service with the appliance model number.
- Operating the appliance with non-authentic parts may lead the appliance to malfunction.
- Manufacturer and distributor are not liable for malfunctions resulting from using non-authentic parts.

PRODUCT FICHE

Complying Commission Delegated Regulation (EU) No 392/2012

Supplier name or trademark		ARÇELİK
Model name		700KT 7182570140
Rated capacity (kg)		7.0
Type of Tumble Dryer	Air Vented	-
	Condenser	•
Energy efficiency class ⁽¹⁾		B
Annual Energy Consumption (kWh) ⁽²⁾		504,2
Type of Control	Automatic	•
	Non-automatic	-
Energy consumption of the standard cotton programme at full load (kWh)		4,21
Energy consumption of the standard cotton programme at partial load (kWh)		2,31
Power consumption of the off-mode for the standart cotton programme at full load, P ₀ (W)		0,50
Power consumption of the left-on mode for the standart cotton programme at full load, P _L (W)		1,00
The duration of the left on mode (min)		30
Standard cotton programme ⁽³⁾		•
Programme time of the standard cotton programme at full load, T _{day} (min)		121
Programme time of the standard cotton programme at partial load, T _{day/2} (min)		72
Weighted programme time of the standard cotton programme at full and partial load (T _j)		93
Condensation efficiency class ⁽⁴⁾		B
Average condensation efficiency of the standard cotton programme at full load, C _{day}		81%
Average condensation efficiency of the standard cotton programme at partial load, C _{day/2}		81%
Weighted condensation efficiency of the standard cotton programme at full load and partial load, C _t		81%
Sound power level for the standard cotton programme at full load ⁽⁵⁾		65
Built-in		-

• : Yes - : No

(1) Scale from A+++ (most efficient) to D (least efficient)

(2) Energy consumption based on 160 drying cycles of the standard cotton programme at full and partial load, and the consumption of the low-power modes. Actual energy consumption per cycle will depend on how the appliance is used.

(3) "Cotton cupboard dry programme" used at full and partial load is the standard drying programme to which the information in the label and the fiche relates, that this programme is suitable for drying normal wet cotton laundry and that it is the most efficient programme in terms of energy consumption for cotton

(4) Scale from G (lest efficient) to A (most efficient)

(5) Weighted average value — L_{WA} expressed in dB(A) re 1 pW

