

# beko

## Refrigerator

User Manual

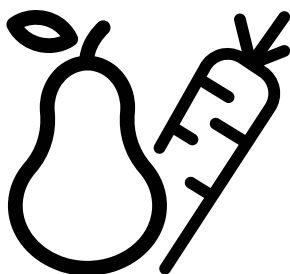

684580MB

CE

EN  
58 6556 0000/AD

## Please read this manual before using the product!

Dear Customer,

We'd like you to make the best use of our product, which has been manufactured in modern facilities with care and meticulous quality controls.





Thus, we advice you to read the entire user manual before you use the product. In case the product changes hands, do not forget to hand the guide to its new owner along with the product.

### This guide will help you use the product quickly and safely.

- Please read the user guide carefully before installing and operating the product.
- Always observe the applicable safety instructions.
- Keep the user guide within easy reach for future use.
- Please read any other documents provided with the product.

Keep in mind that this user guide may apply to several product models. The guide clearly indicates any variations of different models.

	Important information and useful tips.
	Risk of life and property.
	Risk of electric shock.
	The product's packaging is made of recyclable materials, in accordance with the National Environment Legislation.

 <b>INFORMATION</b>	
	
SUPPLIER'S NAME 	MODEL IDENTIFIER → (*) 
.The model information as stored in the product data base can be reached by entering following website and searching for your model identifier (*) found on energy label. <a href="https://eprel.ec.europa.eu/">https://eprel.ec.europa.eu/</a>	

<b>1. Safety and environment instructions</b>	<b>3</b>	<b>4 Preparation</b>	<b>13</b>
1.1. General safety . . . . .	3	<b>5 Using your appliance</b>	<b>14</b>
1.2. Intended use . . . . .	6	5.1. Indicator panel . . . . .	14
1.3. Child safety . . . . .	6	5.2. Dual cooling system . . . . .	16
1.4. Compliance with WEEE Directive and Disposing of the Waste Product . . . . .	7	5.3. Freezing fresh food . . . . .	16
1.5. Compliance with RoHS Directive . . . . .	7	5.4. Recommendations for preserving the frozen food . . . . .	17
1.6. Package information . . . . .	7	5.5. Placement of food . . . . .	17
<b>2 Your appliance</b>	<b>8</b>	5.6. Deep-freeze information . . . . .	17
<b>3 Installation</b>	<b>9</b>	5.7. Ice machine . . . . .	18
3.1. Appropriate installation location . . . . .	9	5.8. Icematic . . . . .	18
3.2. Installing the plastic wedges . . . . .	9	5.9. Ice container . . . . .	19
3.3. Electrical connection . . . . .	10	5.10. Blue Light/HarvestFresh . . . . .	19
3.4. Adjusting the feet . . . . .	10	5.11. Egg holder . . . . .	19
3.5. Illumination lamp . . . . .	10	5.12. Description and cleaning of odor filter . . .	20
3.6. Door open warning . . . . .	10	5.13. The dairy (cold storage) compartment . . .	20
3.7. Transportation of the product . . . . .	11	5.14. Sliding storage container . . . . .	21
<b>4 Preparation</b>	<b>12</b>	5.15. Rotary storage container . . . . .	21
4.1. Things to be done for energy saving . . . . .	12	5.16. Crisper . . . . .	22
4.2. Recommendations on the fridge compartment . . . . .	12	5.17. Using the water dispenser . . . . .	23
4.3. Initial use . . . . .	13	5.18. Filling the water dispenser's tank . . . . .	23
		5.19. Cleaning the water tank . . . . .	24
		5.20. Drip tray . . . . .	25
		5.21. Humidity-controlled crisper (Ever Fresh+) .	25
		5.22. Quick bottle cooling/quick ice making compartment . . . . .	26
		<b>6 Maintenance and Cleaning</b>	<b>28</b>
		6.1. Preventing Bad Odour . . . . .	28
		6.2. Protecting Plastic Surfaces . . . . .	28
		<b>7 Troubleshooting</b>	<b>29</b>

# 1 Safety and environment instructions

This section provides the safety instructions necessary to prevent the risk of injury and material damage. Failure to observe these instructions will invalidate all types of product warranty.

## Intended use



### WARNING:

Keep ventilation openings, in the appliance enclosure or in the built-in structure, clear of obstruction.



### WARNING:

Do not use mechanical devices or other means to accelerate the defrosting process, other than those recommended by the manufacturer.



### WARNING:

Do not damage the refrigerant circuit.



### WARNING:

Do not use electrical appliances inside the food storage compartments of the appliance, unless they are of the type recommended by the manufacturer.

This appliance is intended to be used in household and similar applications such as

- staff kitchen areas in shops, offices and other working environments;
- farm houses and by clients in hotels, motels and other residential type environments;
- bed and breakfast type environments;
- catering and similar non-retail applications.

## 1.1. General safety

- This product should not be used by persons with physical, sensory and mental disabilities, without sufficient knowledge and experience or by children. The device can only be used by such persons under supervision and instruction of a person responsible for their safety. Children should not be allowed to play with this device.
- In case of malfunction, unplug the device.
- After unplugging, wait at least 5 minutes before plugging in again.
- Unplug the product when not in use.
- Do not touch the plug with wet hands! Do not pull the cable to plug off, always hold the plug.

## Important instructions for safety and environment

- Do not plug in the refrigerator if the socket is loose.
- Unplug the product during installation, maintenance, cleaning and repair.
- If the product will not be used for a while, unplug the product and remove any food inside.
- Do not use the product when the compartment with circuit cards located on the upper back part of the product (electrical card box cover) (1) is open.
- Do not wash the product by spraying or pouring water on it! Danger of electric shock!
- In case of malfunction, do not use the product, as it may cause electric shock. Contact the authorised service before doing anything.
- Plug the product into an earthed socket. Earthing must be done by a qualified electrician.
- If the product has LED type lighting, contact the authorised service for replacing or in case of any problem.

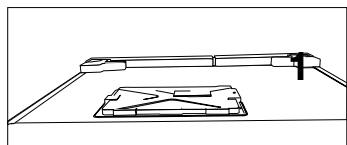
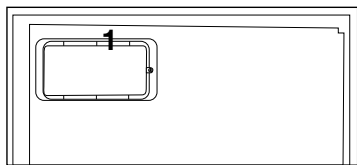

- Do not touch frozen food with wet hands! It may adhere to your hands!
- Do not place liquids in bottles and cans into the freezer compartment. They may explode.
- Place liquids in upright position after tightly closing the lid.
- Do not spray flammable substances near the product, as it may burn or explode.
- Do not keep flammable materials and products with
- Do not use steam or steamed cleaning materials for cleaning the refrigerator and melting the ice inside. Steam may contact the electrified areas and cause short circuit or electric shock!

## Important instructions for safety and environment

flammable gas (sprays, etc.) in the refrigerator.

- Do not place containers holding liquids on top of the product. Splashing water on an electrified part may cause electric shock and risk of fire.
- Exposing the product to rain, snow, sunlight and wind will cause electrical danger. When relocating the product, do not pull by holding the door handle. The handle may come off.
- Take care to avoid trapping any part of your hands or body in any of the moving parts inside the product.
- Do not step or lean on the door, drawers and similar parts of the refrigerator. This will cause the product to fall down and cause damage to the parts.
- Take care not to trap the power cable.

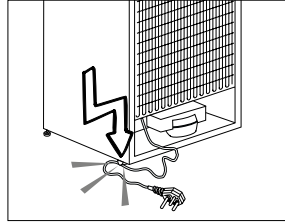

### 1.1.1 HC warning

If the product comprises a cooling system using R600a gas, take care to avoid damaging the cooling system and its pipe while using and moving the product. This gas is flammable. If the cooling system is damaged, keep the product away from sources of fire and ventilate the room immediately.



The label on the inner left side indicates the type of gas used in the product.

### 1.1.2 For models with water dispenser

- Pressure for cold water inlet shall be maximum 90 psi (6.2 bar). If your water pressure exceeds 80 psi (5.5 bar), use a pressure limiting valve in your mains system. If you do not know how to check your water

## Important instructions for safety and environment

- pressure, ask for the help of a professional plumber.
- If there is risk of water hammer effect in your installation, always use a water hammer prevention equipment in your installation. Consult Professional plumbers if you are not sure that there is no water hammer effect in your installation.
  - Do not install on the hot water inlet. Take precautions against the risk of freezing of the hoses. Water temperature operating interval shall be 33°F (0.6°C) minimum and 100°F (38°C) maximum.
  - Use drinking water only.

### 1.2. Intended use

- This product is designed for home use. It is not intended for commercial use.
- The product should be used to store food and beverages only.
- Do not keep sensitive products requiring controlled temperatures (vaccines, heat sensitive medication,

medical supplies, etc.) in the refrigerator.

- The manufacturer assumes no responsibility for any damage due to misuse or mishandling.

### 1.3. Child safety

- Keep packaging materials out of children's reach.
- Do not allow the children to play with the product.
- If the product's door comprises a lock, keep the key out of children's reach.
- Original spare parts will be provided for 10 years, following the product purchasing date.

## Important instructions for safety and environment

### 1.4. Compliance with WEEE Directive and Disposing of the Waste Product

This product complies with EU WEEE Directive (2012/19/EU). This product bears a classification symbol for waste electrical and electronic equipment (WEEE).

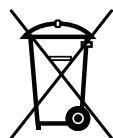

This product has been manufactured with high quality parts and materials which can be reused and are suitable for recycling. Do not dispose of the waste product with normal domestic and other wastes at the

end of its service life. Take it to the collection center for the recycling of electrical and electronic equipment. Please consult your local authorities to learn about these collection centers.

### 1.5. Compliance with RoHS Directive

- This product complies with EU WEEE Directive (2011/65/EU). It does not contain harmful and prohibited materials specified in the Directive.

### 1.6. Package information

- Packaging materials of the product are manufactured from recyclable materials in accordance with our National Environment Regulations. Do not dispose of the packaging materials together with the domestic or other wastes. Take them to the packaging material collection points designated by the local authorities.



## 2 Your appliance

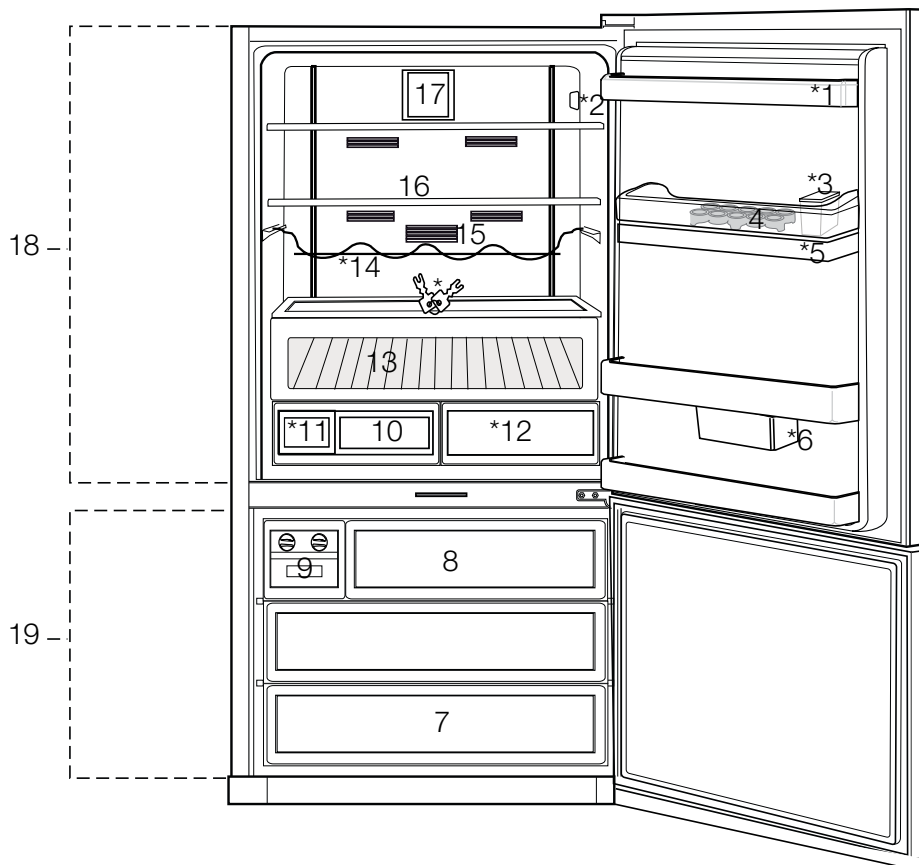

1. Door shelves of fridge compartment
  2. Display
  3. Water dispenser filling tank
  4. Egg section
  5. Water dispenser reservoir
  6. Rotary storage container
  7. Freezer compartment drawers
  8. Icematic drawer
  9. Icematic
  10. Crisper
  11. Water tank
  12. Crisper
  13. The dairy (cold storage) compartment
  14. Bottle shelf
  15. Odor filter
  16. Glass shelves of fridge compartment
  17. Fan
  18. Glass shelves of fridge compartment
  19. Freezer compartment
- \*optional







**\*optional:** Figures in this user manual are given as an example and may not match the product exactly. If the relevant parts are not available in the product you purchased, the figure applies to other models.

## 3 Installation

Always have the installation and repairing procedures carried out by the Authorized Service Agent. Manufacturer shall not be held liable for damages that may arise from procedures carried out by unauthorized persons.

Refer to the nearest Authorized Service Agent for installation of the product. To make the product ready for use, make sure that the electricity installation is appropriate before calling the Authorized Service Agent. If not, call a qualified electrician to have any necessary arrangements carried out.

	Preparation of the location and electrical installation at the place of installation is under customer's responsibility.
	Product must not be plugged in during installation. Otherwise, there is the risk of death or serious injury!
	<b>WARNING:</b> Installation and electrical connections of the product must be carried out by the Authorised Service Agent. Manufacturer shall not be held liable for damages that may arise from procedures carried out by unauthorised persons.
	<b>WARNING:</b> Prior to installation, visually check if the product has any defects on it. If so, do not have it installed. Damaged products cause risks for your safety.
	Make sure that the power cable is not pinched or crushed while pushing the product into its place after installation or cleaning procedures.

### 3.1. Appropriate installation location

	<b>WARNING:</b> If the door of the room where the product will be placed is too small for the product to pass, then the product's doors must be removed and the product must be turned aside to pass it through.
--	--

- Choose a place at where you would use the product comfortably.
- Install the product at least 30 cm away from heat sources such as hobs, ovens, heater cores and stoves and at least 5 cm away from electrical ovens. Product must not be subjected

to direct sun light and kept in humid places after installation.

- Your product requires adequate air circulation to function efficiently. If the product will be placed in an alcove, remember to leave at least 5 cm clearance between the product and the ceiling, rear wall and the side walls.
- If the product will be placed in an alcove, remember to leave at least 5 cm clearance between the product and the ceiling, rear wall and the side walls. Check if the rear wall clearance protection component is present at its location (if provided with the product). If the component is not available, or if it is lost or fallen, position the product so that at least 5 cm clearance shall be left between the rear surface of the product and the wall of the room. The clearance at the rear is important for efficient operation of the product.
- Do not place the product on the materials such as rugs or carpets.
- Place the product on an even floor surface to prevent jolts.
- Do not install the product in places where the temperature falls below 10°C.

	If two coolers are to be installed side by side, there should be at least 8 cm distance between them. Otherwise, adjacent side walls may get damp.
---	--

### 3.2. Installing the plastic wedges

Plastic wedges are used to create the distance for the air circulation between the product and the rear wall. Insert the 2 plastic wedges onto the rear ventilation cover as illustrated in the figure. To install the wedges, remove the screws on the product and use the screws given in the same pouch with the wedges.

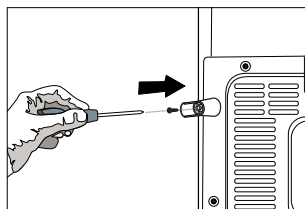
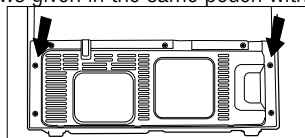



## Installation

### 3.3. Electrical connection

Connect the product to a grounded outlet protected by a fuse complying with the values in the rating plate. Our company shall not be liable for any damages that will arise when the product is used without grounding in accordance with the local regulations.

- Electrical connection must comply with national regulations.
- Power cable plug must be within easy reach after installation.
- The voltage and allowed fuse or breaker protection are specified in the Rating Plate which is affixed to interior of the product. If the current value of the fuse or breaker in the house does not comply with the value in the rating plate, have a qualified electrician install a suitable fuse.
- The specified voltage must be equal to your mains voltage.
- Do not make connections via extension cables or multi-plugs.

	<b>WARNING:</b> Damaged power cable must be replaced by the Authorized Service Agent.
	<b>WARNING:</b> If the product has a failure, it should not be operated unless it is repaired by the Authorised Service Agent! There is the risk of electric shock!

### 3.4. Adjusting the feet

If the product stands unbalanced after installation adjust the feet. Taking help from someone to slightly lift the product will facilitate this process.

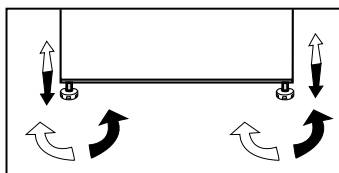

	<b>WARNING:</b> First unplug the product. Product must not be plugged in when adjusting the feet. There is the risk of electric shock!
---	--

Turn the front feet to balance the product. The corner where the foot exists is lowered when you turn in the direction of arrow and raised when you turn it in the opposite direction.

### 3.5. Illumination lamp

Do not attempt to repair yourself but call the Authorized Service Agent if the illumination lamps do not go on or are out of order.

The lamp(s) used in this appliance is not suitable for household room illumination. The intended purpose of this lamp is to assist the user to place foodstuffs in the refrigerator/freezer in a safe and comfortable way.

### 3.6. Door open warning

**(This feature is optional)**

An audio warning signal will be given when the door of your product is left open for 1 minute. This warning will be muted when the door is closed or any of the display buttons (if any) are pressed.

## Installation

### 3.7. Transportation of the product

1. Unplug the product before transporting it.
2. Clean the interior of the product as recommended in the “Maintenance and cleaning” section.
3. Secure the shelves, accessories, crisper and etc. in the product by adhesive tape before repackaging it.

	Packaging must be tied with thick tapes or strong ropes and the rules of transportation printed on the package must be followed.
	Original packaging and foam materials should be kept for future transportations.
	Packaging materials are dangerous for the children. Keep packaging materials in a safe place away from reach of the children.

## 4 Preparation

### 4.1. Things to be done for energy saving



Connecting the product to electric energy saving systems is risky as it may cause damage on the product.

- For a freestanding appliance; 'this refrigerating appliance is not intended to be used as a built-in appliance' ;
- Do not leave the doors of your product open for a long time.
- Do not put hot food or drinks in your product.
- Do not overload the product. Cooling capacity will fall when the air circulation inside is hindered.
- Do not place the product in places subject to direct sunlight. Install the product at least 30 cm away from heat sources such as hobs, ovens, heater cores and stoves and at least 5 cm away from electrical ovens.
- Store your food in product in closed containers.
- You can load maximum amount of food to the freezer compartment of the product by removing the freezer compartment shelf of drawer. Declared energy consumption value of the product was determined with the freezer compartment shelf or drawer removed and with maximum amount of food loaded. There is no risk in using a shelf or drawer suitable for the shapes and sizes of the foods to be frozen.
- Thawing frozen food in fridge compartment will both provide energy saving and preserve the food quality.
- Since hot and humid air will not directly penetrate into your product when the doors are not opened, your product will optimize itself in conditions sufficient to protect your food. In this energy saving function, functions and components such as compressor, fan, heater, defrost, lighting, display and so on will operate according to the needs to consume minimum energy while maintaining the freshness of your foodstuff.
- In case of multiple options are present glass shelves must be placed so that the air outlets at the backwall are not blocked, preferably air outlets are remaining below the glass shelf. This combination may help improving air distribution and energy efficiency.



The ambient temperature of the room where you install the product should at least be  $-5^{\circ}\text{C}$ . Operating your product under cooler conditions than this is not recommended.



Inside of your product must be cleaned.



If two coolers are to be installed side by side, there should be at least 4 cm distance between them.

### 4.2. Recommendations on the fridge compartment

- Do not allow the food to touch the temperature sensor in fridge compartment. To allow the fridge compartment keep its ideal storage temperature, sensor must not be hindered by food.
- The baskets/drawers that are provided with the chill compartment must always be in use for low energy consumption and for better storage conditions.
- Food contact with the temperature sensor in the freezer compartment may increase energy consumption of the appliance. Thus any contact with the sensor(s) must be avoided.
- Do not put hot food and beverages inside the product.

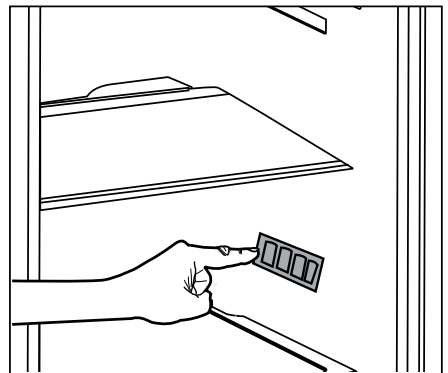

## 4 Preparation

### 4.3. Initial use

Before starting to use the product, check that all preparations are made in accordance with the instructions in sections "Important instructions for safety and environment" and "Installation".

- Clean the interior of the product as recommended in the "Maintenance and cleaning" section. Check that inside of it is dry before operating it.
- Plug the product into the grounded wall outlet. When the door is opened the interior illumination will turn on.
- Run the product without putting any food for 6 hours and do not open its door unless certainly required.



You will hear a noise when the compressor starts up. The liquids and gases sealed within the refrigeration system may also give rise to noise, even if the compressor is not running and this is quite normal.



Front edges of the product may feel warm. This is normal. These areas are designed to be warm to avoid condensation.



In some models, the instrument panel automatically turns off 5 minutes after the door has closed. It will be reactivated when the door has opened or pressed on any key.

## 5 Using your appliance

### 5.1. Indicator panel

Indicator panels may vary according to the product model.

Audio – visual functions on the indicator panel helps you in using your product.

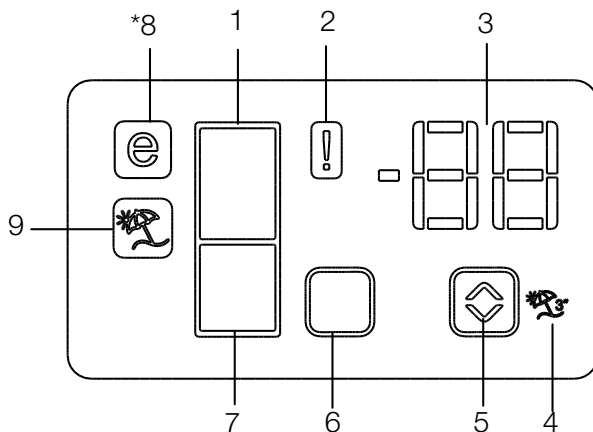

1. Fridge Compartment Indicator
2. Error status indicator
3. Temperature indicator
4. Vacation function button
5. Temperature setting button
6. Compartment selection button
7. Freezer compartment indicator
8. Economy mode indicator
9. Vacation function indicator

**\*optional**



**\*Optional:** Figures in this user manual are given as an example and may not match the product exactly. If the relevant parts are not available in the product you purchased, the figure applies to other models.

## 5 Using your appliance

### 1. Fridge compartment indicator

Fridge compartment light is illuminated while the fridge compartment temperature is set.

### 2. Error status indicator

If your refrigerator does not perform enough cooling or in case of a sensor fault, this indicator is activated. When this indicator is activated, "E" is displayed on the freezer compartment temperature indicator, and numbers such as "1,2,3..." are displayed on the fridge compartment temperature indicator. These numbers on the indicator inform service personnel about the error.

### 3. Temperature indicator

Indicates freezer, fridge compartment temperature.

### 4. Vacation function button

Press on Vacation Button for 3 seconds to activate this function. When the vacation function is activated, "- -" is displayed on the fridge compartment temperature indicator and no active cooling is performed on the fridge compartment. It is not suitable to keep the food in the fridge compartment when this function is activated. Other compartments shall be continued to be cooled as per their set temperature.

To cancel this function press **Vacation** button again.

### 5. Temperature setting button

Changes the temperature of the relevant compartment between -24°C... -18°C and 8°C...1°C.

### 6. Compartment selection button

Selection button: Press compartment selection button to switch between fridge and freezer compartments.

### 7. Freezer compartment indicator

Fridge compartment light is illuminated while the freezer compartment temperature is set.

### 8. Economy mode indicator

Indicates that the refrigerator operates in energy saving mode. This display shall be activated if the freezer compartment temperature is set to -18°C.

### 9. Vacation function indicator

Indicates that vacation is activated.



## Using your appliance

### 5.2. Dual cooling system

Your product is equipped with two separate cooling systems to cool the fresh food compartment and freezer compartment. Thus, air and odor in the fresh food compartment and frozen food compartment do not get mixed. Thanks to these two separate cooling systems, cooling speed is much higher than other refrigerators. Also additional power saving is provided since the defrosting is performed individually.

### 5.3. Freezing fresh food

- Place the food in the product wrapped or covered.
- Hot food must be cooled down to the room temperature before putting them in the product.
- The food that you want to freeze must be fresh and in good quality.
- Divided the food into portions according to your family's daily or meal based consumption needs.
- Pack the food in an airtight manner to prevent them from drying even if they are going to be stored for a short time.

- Materials to be used for packaging must be tear-proof and resistant to cold, humidity, odor, oils and acids and they must also be airtight. Moreover, they must be well closed and they must be made from easy-to-use materials that are suitable for deep-freezers.
- Frozen food must be used immediately after they are thawed and they should never be re-frozen.
- Do not freeze too large quantities of food at one time. The quality of the food is best preserved when it is frozen right through to the core as quickly as possible.
- Placing warm food into the freezer compartment causes the cooling system to operate continuously until the food is frozen solid.
- Take special care not to mix already frozen food and fresh food.
- If the product has a quick freeze function, activate the quick freeze function when you want to freeze the food.

Freezer compartment setting	Fridge compartment setting	Remarks
-18°C	4°C	This is the normal recommended setting.
-20, -24 or -24°C	4°C	These settings are recommended when the ambient temperature exceeds 30°C.
Quick freeze	4°C	Use when you wish to freeze your food in a short time. Your product will return to its previous mode when the process is over.
-18°C or colder	2°C	Use these settings if you think that your fridge compartment is not cold enough because of the hot ambient conditions or frequent opening and closing of the door.
-18°C or colder	Quick fridge	Use this function when you place too much into the fridge compartment or when you need to cool your food quickly. It is recommended that you activate quick fridge function 4-8 hours before placing the food.

## Using your appliance

### 5.4. Recommendations for preserving the frozen food

• Frozen food that you have purchased should be stored in accordance with the frozen food manufacturer's instructions for a frozen food storage compartment.

Note the following to ensure that the high quality achieved by the frozen food manufacturer and the food retailer is maintained:

1. Put packages in the freezer as quickly as possible after purchase.
2. Ensure that contents are labeled and dated.
3. Do not exceed "Use By", "Best Before" dates on the packaging.

### 5.5. Placement of food

Freezer compartment shelves	Various frozen food such as meat, fish, ice cream, vegetables and etc.
Egg section	Eggs
Refrigerator compartment shelves	Food in pans, covered plates and closed containers
Door shelves of fridge compartment	Small and packaged food and beverage (such as milk, fruit juice, beer and etc.)
Crisper	Vegetables and fruits
Freshzone compartment	Delicatessen products (cheese, butter, salami and etc.)

### 5.6. Deep-freeze information

Food must be frozen as rapidly as possible when they are put in a product refrigerator in order to keep them in good quality.

It is possible to preserve the food for a long time only at -18°C or lower temperatures.

You can keep the freshness of food for many months (at -18°C or lower temperatures in the deep freeze).

Divided the food into portions according to your family's daily or meal based consumption needs.

Pack the food in an airtight manner to prevent them from drying even if they are going to be stored for a short time.

Materials necessary for packaging:

- Cold resistant adhesive tape
- Self-adhesive label
- Rubber rings
- Pen

Materials to be used for packaging the foodstuff must be tear-proof and resistant to cold, humidity, dour, oils and acids.

Foods to be frozen should not be allowed to come in contact with the previously frozen items to prevent them from getting thawed partially.

Frozen food must be used immediately after they are thawed and they should never be re-frozen.

## Using your appliance

### 5.7. Ice machine

#### \*optional

Icematic allows you to obtain ice from the product easily.

Using the icematic

1. Remove the water tank from the fridge compartment.
2. Fill water tank with water.
3. Replace the water tank. First ice cubes will be ready in approximately four hours in the icematic drawer located in the freezer compartment.



While the water tank is completely filled, you will be able to obtain approximately 60-70 ice cubes.



The water within the tank should be renewed in every 2-3 weeks.

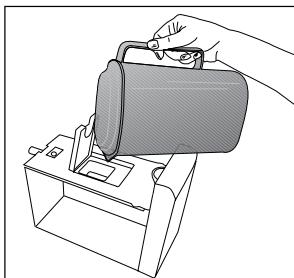
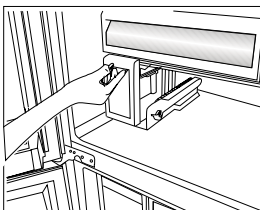
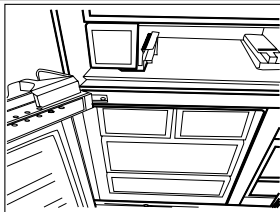

### 5.8. Icematic

#### \*optional

Icematic allows you to obtain ice from the product easily.

#### Using the icematic

1. Take out the icematic pulling it out carefully.
2. Fill the Icematic with water.
3. Place Icematic in place. About two hours later, the ice is ready.
4. To obtain ice, turn the knobs on the ice reservoirs clockwise by 90° degrees. Ice cubes in the reservoirs will fall down into the ice storage container below.
5. You may take out the ice storage container and serve the ice cubes.



Do not remove the Icematic from its seating to obtain ice.



If you wish, you may keep the ice cubes in the ice storage container. The ice storage container is just for accumulating ice cubes. Do not put water in it. Otherwise, it will break.

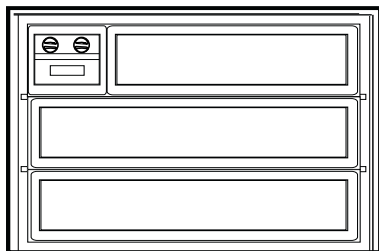
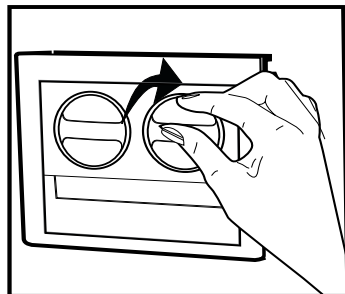

## Using your appliance

### 5.9. Ice container

#### \*optional

Icematic allows you to obtain ice from the product easily.

#### Using the ice container

1. Remove the ice container from the freezer compartment.
2. Fill the ice container with water.
3. Place the ice container in the freezer compartment. About two hours later, the ice is ready.
4. Remove the ice container from the freezer compartment and bend it over the service plate. Ice cubes will easily fall down to the service plate.

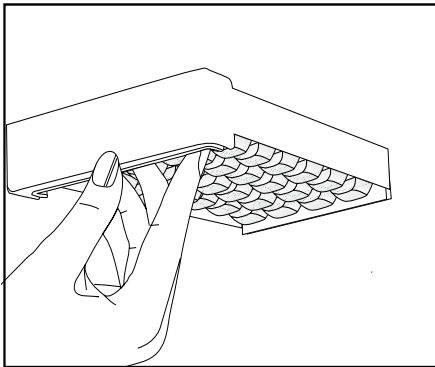

### 5.10. Blue Light/HarvestFresh

#### (Optional)

#### For Blue light,

Vegetables and fruit stored in crispers illuminated with blue light continue to perform photosynthesis and retain their levels of C vitamin thanks to the effect of the wavelength of the blue light.

#### For HarvestFresh,

Vegetables and fruit stored in crispers illuminated with HarvestFresh technology retain their vitamin levels (vitamins A and C) for a longer period thanks to the cycles of blue, green, red lights and dark that simulate the cycle of the day.

When the door of your refrigerator is opened during the dark period of the HarvestFresh technology, your refrigerator shall sense this automatically and illuminate the crisper with one of the blue, green or red lights respectively for your convenience. The dark period shall be continued when you close the door of your refrigerator so that it shall represent the night period of the day cycle.

### 5.11. Egg holder

You can install the egg holder to the desired door or body shelf. If it will be placed on body shelves than the lower cooler shelves are recommended.



Never place the egg holder in the freezer compartment



Make sure that eggs are not in direct contact with other food products.

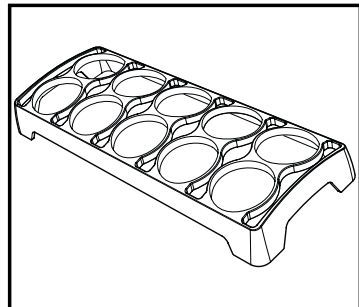

## Using your appliance

### 5.12. Description and cleaning of odor filter

Odor filter prevents unpleasant odor build-up in your product.

1. Pull the cover into which the odor filter is installed downwards from the front section and remove as illustrated.
2. Leave the filter under sunlight for one day. Filter will be cleaned during this time.
3. Install the filter back to its place.



Odor filter must be cleaned once in a year.

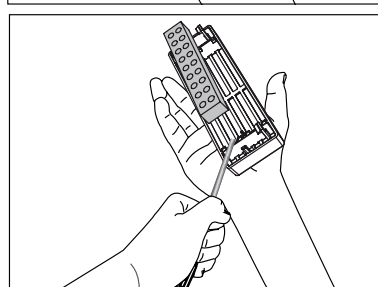
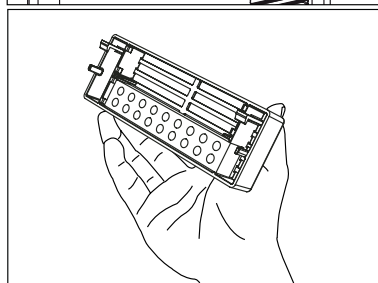
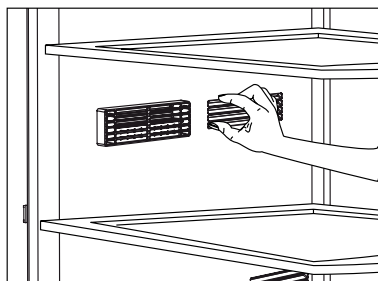

### 5.13. The dairy (cold storage) compartment

The dairy (cold storage) compartment” provides lower temperature than the refrigerator compartment. Use this compartment to store delicatessen (salami, sausages, dairy products and etc. ) that requires lower storage temperature or meat, chicken or fish products for immediate consumption. Do not store fruits and vegetables in this compartment.

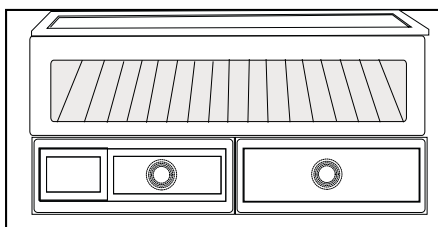

## Using your appliance

### 5.14. Sliding storage container

#### \*optional

This accessory is designed to increase the usable volume of the door shelves. It allows you to easily place the tall bottles, jars and tins to the lower bottle shelf thanks to its ability to move right or left.

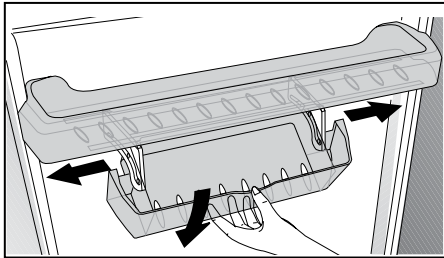

### 5.15. Rotary storage container

#### \*optional

Rotary storage container can also be moved to right or left. In this way, long bottles, jars or boxes can be placed easily in the bottom shelf (Fig. 1).

You can reach the food that you have placed into the shelf by grabbing and turning it from its right edge (Fig.2).

When you want to load or remove it to clean, turn it by 90 degrees, raise it up and pull towards yourself (Fig. 3-4).

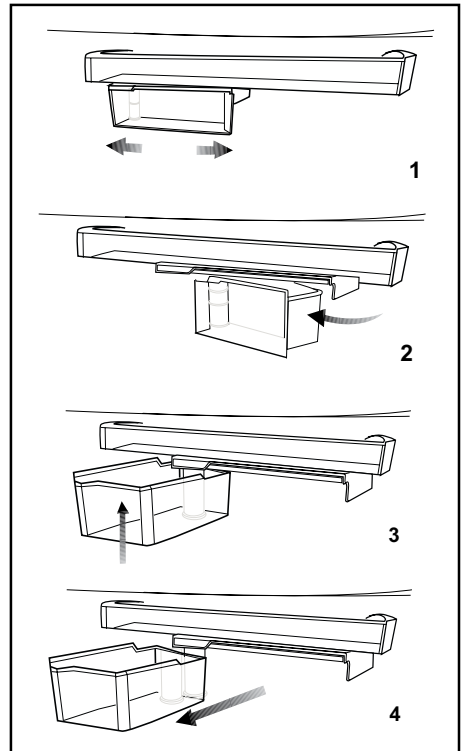

## Using your appliance

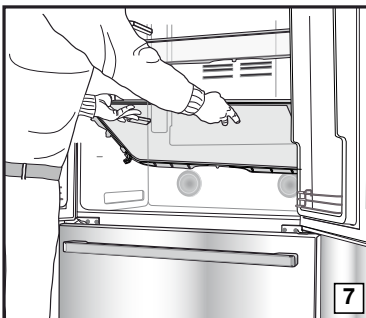
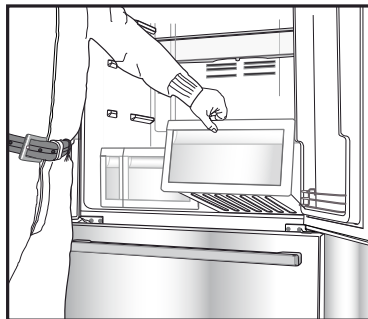
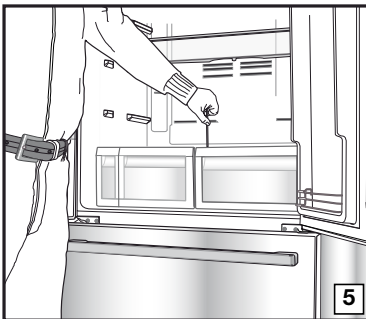
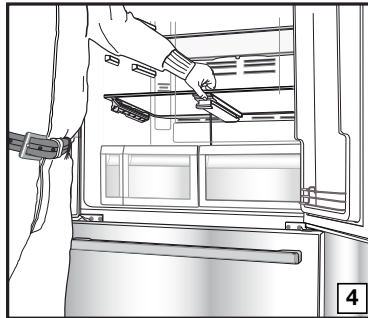
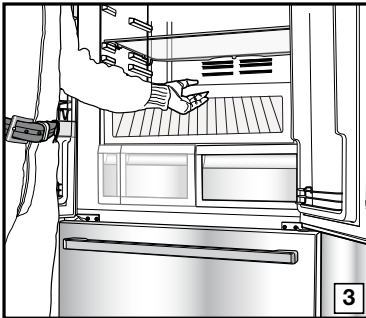
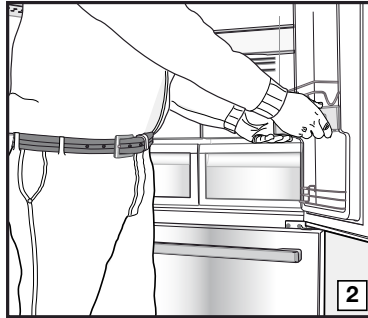
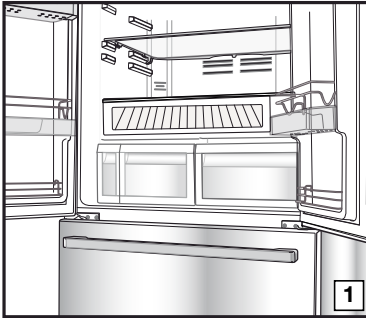



### 5.16. Crisper

Crisper of the product is designed specially to keep the vegetables fresh without losing their humidity. For this purpose, cool air circulation is intensified around the crisper in general. Remove the door shelves that stand against the crisper before removing the crispers.

## Using your appliance

### 5.17. Using the water dispenser

\*optional

	It is normal for the first few glasses of water taken from the dispenser to be warm.
	If the water dispenser is not used for a long period of time, dispose of first few glasses of water to obtain fresh water.

1. Push in the lever of the water dispenser with your glass. If you are using a soft plastic cup, pushing the lever with your hand will be easier.
2. After filling the cup up to the level you want, release the lever.

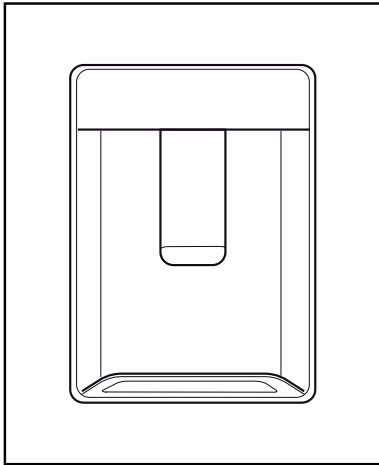

	Please note, how much water flows from the dispenser depends on how far you depress the lever. As the level of water in your cup / glass rises, gently reduce the amount of pressure on the lever to avoid overflow. If you slightly press the arm, the water will drip; this is quite normal and not a failure.
---	--

### 5.18. Filling the water dispenser's tank

Water tank filling reservoir is located inside the door rack.

1. Open the cover of the tank.
2. Fill the tank with fresh drinking water.
3. Close the cover.

	Do not fill the water tank with any other liquid except for water such as fruit juices, carbonated beverages or alcoholic drinks which are not suitable to use in the water dispenser. Water dispenser will be irreparably damaged if these kinds of liquids are used. Warranty does not cover such usages. Some chemical substances and additives contained in these kinds of drinks/liquids may damage the water tank.
---	--

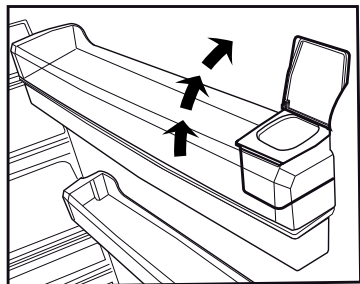
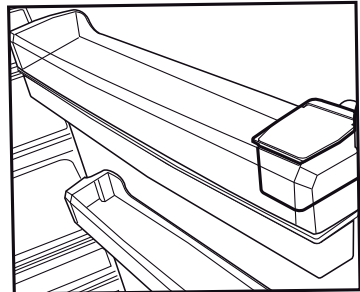



## Using your appliance



Use clean drinking water only.



Capacity of the water tank is 3 liters; do not overfill.

### 5.19. Cleaning the water tank

1. Remove the water filling reservoir inside the door rack.
2. Remove the door rack by holding from both sides.
3. Grab the water tank from both sides and remove it with an angle of 45°C.
4. Remove the cover of the water tank and clean the tank.



Components of the water tank and water dispenser should not be washed in dishwasher.

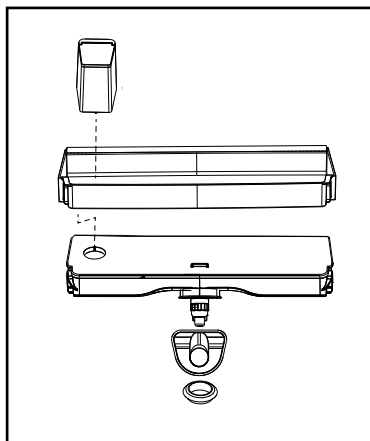
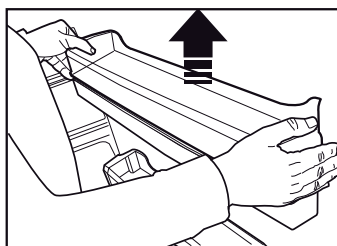
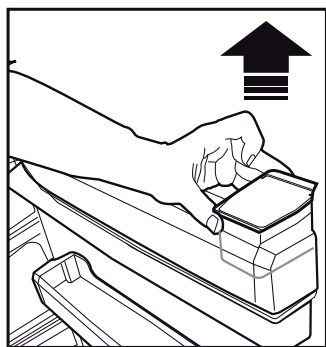
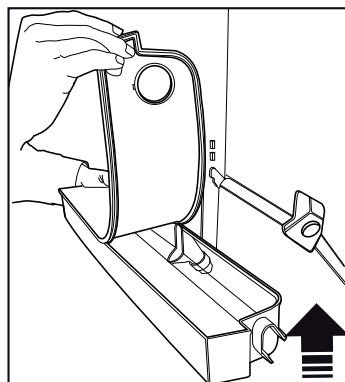
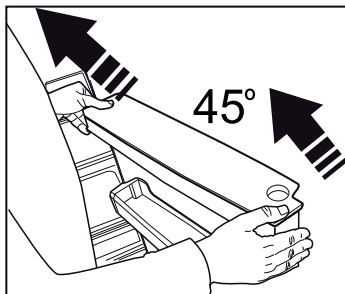

## Using your appliance

### 5.20. Drip tray

Water that dripped while using the water dispenser accumulates in the spillage tray.

Remove the plastic filter as shown in the figure.

With a clean and dry cloth, remove the water that has accumulated.

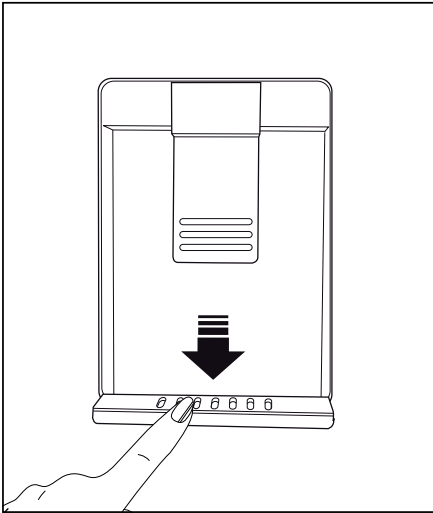

### 5.21. Humidity-controlled crisper (Ever Fresh+)

#### \*optional

Humidity rates of the vegetables and fruit are kept under control with the feature of humidity-controlled crisper and the food is ensured to stay fresh for longer.

Never leave the vegetables inside the crisper in their bags. If the vegetables are left inside their bags, this will cause them to decompose in a short period of time. When a high level of humidity is set, your vegetables keep their humidity content and can be preserved for a reasonable period of time without needing to leave them inside their bags. In case contacting with other vegetables is not preferred for hygiene concerns, use a perforated paper, foam and other similar packaging materials instead of a bag.

While the vegetables are being placed, specific gravity of the vegetables should be taken into consideration. Heavy and hard vegetables should be put at the bottom of the crisper and the lightweight and soft vegetables should be placed over.

Do not place together the pear, apricot, peach, etc. and apple in particular which have a high level of generation of ethylene gas in the same crisper with the other vegetables and fruit. The ethylene gas which is emitted by these fruit may cause the other fruit to ripen faster and decompose in a shorter time.

Do not take the crisper main body out of the refrigerator apart from the drawers unless you have to, and call for technical service if necessary. Before removing the crisper main body from its place, wipe and clean it with a wet piece of cloth.

## Using your appliance

### 5.22. Quick bottle cooling/quick ice making compartment

**(Rapid Cooler)**

**(This feature is optional)**

You can use the quick bottle cooling compartment for making ice or cooling your beverages quickly.

This closed compartment, which is located at the lower left part in the fridge compartment, is cooled with the help of a separate fan and cooler surface.

After placing the icebox or the beverage you want to cool in this compartment, you can initiate the quick fridge function by pressing the relevant buttons on the indicator.



When the cooling is done, the "=" symbol on the indicator disappears. After the process ends, remove the beverage or the ice you have placed in the compartment. If you want to cool them further, you can activate the same function again while your beverage or icebox is inside the compartment.



If you see "0" warning message on the display when you want to activate the quick bottle cooling function, wait for a while. This warning message may appear when you have used the compartment 4 times at frequent intervals. When you see this message, your refrigerator will not allow the compartment to be used for a while in order to deliver the best cooling performance and maintain the storage temperature of the food. When the inner temperatures of the refrigerator are balanced, the compartment will be ready to be used again. Please try again later.



If you see "0" warning message on the display when you want to activate the ice making function, wait for a while. This warning message may appear when you have used the compartment 2 times at frequent intervals. When you see this message, your refrigerator will not allow the compartment to be used for a while in order to deliver the best cooling performance and maintain the storage temperature of the food. When the inner temperatures of the refrigerator are balanced, the compartment will be ready to be used again. Please try again later.



Do not place any other material in this compartment other than beverages and the supplied icebox. Make sure that the caps of the beverages you are going to put in the compartment are closed.



Before activating the function, ensure that the door of the compartment is completely closed. This compartment has been designed to cool 1.5 liters of water at 20°C down to 10°C in 15 minutes. If you think that the beverage you are going to remove from the compartment is not cold enough, you can activate the compartment again.

## Using your appliance



Do not leave a cold beverage inside the compartment for your own hygiene and safety. Keeping your fizzy drinks in the compartment for a long time may lead to risks such as cracking etc.

When the ice making function is over, the ice in the icebox may melt as the compartment will return to fresh food storing temperatures.

Do not leave frozen ice in the compartment.

When this compartment is activated, the fan in the compartment will operate at the highest speed in order to deliver the best cooling performance in the shortest period of time. For this reason, the sound that will arise when the compartment is operating is normal.

## 6 Maintenance and Cleaning

Cleaning the product regularly will prolong its service life.



**WARNING:** Disconnect the power before cleaning the refrigerator.

- Do not use sharp and abrasive tools, soap, house cleaning materials, detergents, gas, gasoline, varnish and similar substances for cleaning.
- Melt a teaspoonful of carbonate in the water. Moisten a piece of cloth in the water and wring out. Wipe the device with this cloth and dry off thoroughly.
- Take care to keep water away from the lamp's cover and other electrical parts.
- Clean the door using a wet cloth. Remove all items inside to detach the door and chassis shelves. Lift the door shelves up to detach. Clean and dry the shelves, then attach back in place by sliding from above.
- Do not use chloric water or cleaning products on the exterior surface and chrome-coated parts of the product. Chlorine will cause rust on such metallic surfaces.
- Do not use sharp, abrasive tools, soap, household cleaning agents, detergents, kerosene, fuel oil, varnish etc. to prevent removal and deformation of the prints on the plastic part. Use lukewarm water and a soft cloth for cleaning and then wipe it dry.

### 6.1. Preventing Bad Odour

The product is manufactured free of any odorous materials. However, keeping the food in inappropriate sections and improper cleaning of internal surfaces may lead to malodour.

To avoid this, clean the inside with carbonated water every 15 days.

- Keep the foods in sealed holders. Microorganisms may spread out of unsealed food items and cause malodour.
- Do not keep expired and spoilt foods in the refrigerator.

### 6.2. Protecting Plastic Surfaces

Oil spilled on plastic surfaces may damage the surface and must be cleaned immediately with warm water.

## 7 Troubleshooting

Check this list before contacting the service. Doing so will save you time and money. This list includes frequent complaints that are not related to faulty workmanship or materials. Certain features mentioned herein may not apply to your product.

### **The refrigerator is not working.**

- The power plug is not fully settled. >>> Plug it in to settle completely into the socket.
- The fuse connected to the socket powering the product or the main fuse is blown. >>> Check the fuses.

### **Condensation on the side wall of the cooler compartment (MULTI ZONE, COOL, CONTROL and FLEXI ZONE).**

- The environment is too cold. >>> Do not install the product in environments with temperatures below -5°C.
- The door is opened too frequently >>> Take care not to open the product's door too frequently.
- The environment is too humid. >>> Do not install the product in humid environments.
- Foods containing liquids are kept in unsealed holders. >>> Keep the foods containing liquids in sealed holders.
- The product's door is left open. >>> Do not keep the product's door open for long periods.
- The thermostat is set to too low temperature. >>> Set the thermostat to appropriate temperature.

### **Compressor is not working.**

- In case of sudden power failure or pulling the power plug off and putting back on, the gas pressure in the product's cooling system is not balanced, which triggers the compressor thermic safeguard. The product will restart after approximately 6 minutes. If the product does not restart after this period, contact the service.
- Defrosting is active. >>> This is normal for a fully-automatic defrosting product. The defrosting is carried out periodically.
- The product is not plugged in. >>> Make sure the power cord is plugged in.
- The temperature setting is incorrect. >>> Select the appropriate temperature setting.
- The power is out. >>> The product will continue to operate normally once the power is restored.

### **The refrigerator's operating noise is increasing while in use.**

- The product's operating performance may vary depending on the ambient temperature variations. This is normal and not a malfunction.

### **The refrigerator runs too often or for too long.**

## Troubleshooting

- The new product may be larger than the previous one. Larger products will run for longer periods.
- The room temperature may be high. >>> The product will normally run for long periods in higher room temperature.
- The product may have been recently plugged in or a new food item is placed inside. >>> The product will take longer to reach the set temperature when recently plugged in or a new food item is placed inside. This is normal.
- Large quantities of hot food may have been recently placed into the product. >>> Do not place hot food into the product.
- The doors were opened frequently or kept open for long periods. >>> The warm air moving inside will cause the product to run longer. Do not open the doors too frequently.
- The freezer or cooler door may be ajar. >>> Check that the doors are fully closed.
- The product may be set to temperature too low. >>> Set the temperature to a higher degree and wait for the product to reach the adjusted temperature.
- The cooler or freezer door washer may be dirty, worn out, broken or not properly settled. >>> Clean or replace the washer. Damaged / torn door washer will cause the product to run for longer periods to preserve the current temperature.

### **The freezer temperature is very low, but the cooler temperature is adequate.**

- The freezer compartment temperature is set to a very low degree. >>> Set the freezer compartment temperature to a higher degree and check again.

### **The cooler temperature is very low, but the freezer temperature is adequate.**

- The cooler compartment temperature is set to a very low degree. >>> Set the freezer compartment temperature to a higher degree and check again.

### **The food items kept in cooler compartment drawers are frozen.**

- The cooler compartment temperature is set to a very low degree. >>> Set the freezer compartment temperature to a higher degree and check again.

### **The temperature in the cooler or the freezer is too high.**

## Troubleshooting

- The cooler compartment temperature is set to a very high degree. >>> Temperature setting of the cooler compartment has an effect on the temperature in the freezer compartment. Wait until the temperature of relevant parts reach the sufficient level by changing the temperature of cooler or freezer compartments.
- The doors were opened frequently or kept open for long periods. >>> Do not open the doors too frequently.
- The door may be ajar. >>> Fully close the door.
- The product may have been recently plugged in or a new food item is placed inside. >>> This is normal. The product will take longer to reach the set temperature when recently plugged in or a new food item is placed inside.
- Large quantities of hot food may have been recently placed into the product. >>> Do not place hot food into the product.

### **Shaking or noise.**

- The ground is not level or durable. >>> If the product is shaking when moved slowly, adjust the stands to balance the product. Also make sure the ground is sufficiently durable to bear the product.
- Any items placed on the product may cause noise. >>> Remove any items placed on the product.

### **The product is making noise of liquid flowing, spraying etc.**

- The product's operating principles involve liquid and gas flows. >>> This is normal and not a malfunction.

### **There is sound of wind blowing coming from the product.**

- The product uses a fan for the cooling process. This is normal and not a malfunction.

### **There is condensation on the product's internal walls.**

- Hot or humid weather will increase icing and condensation. This is normal and not a malfunction.
- The doors were opened frequently or kept open for long periods. >>> Do not open the doors too frequently; if open, close the door.
- The door may be ajar. >>> Fully close the door.

### **There is condensation on the product's exterior or between the doors.**

- The ambient weather may be humid, this is quite normal in humid weather. >>> The condensation will dissipate when the humidity is reduced.

### **The interior smells bad.**



## Troubleshooting

- The product is not cleaned regularly. >>> Clean the interior regularly using sponge, warm water and carbonated water.
- Certain holders and packaging materials may cause odour. >>> Use holders and packaging materials without free of odour.
- The foods were placed in unsealed holders. >>> Keep the foods in sealed holders. Micro-organisms may spread out of unsealed food items and cause malodour. Remove any expired or spoilt foods from the product.

### **The door is not closing.**

- Food packages may be blocking the door. >>> Relocate any items blocking the doors.
- The product is not standing in full upright position on the ground. >>> Adjust the stands to balance the product.
- The ground is not level or durable. >>> Make sure the ground is level and sufficiently durable to bear the product.

### **The vegetable bin is jammed.**

- The food items may be in contact with the upper section of the drawer. >>> Reorganize the food items in the drawer.

### **If The Surface Of The Product Is Hot.**

- High temperatures may be observed between the two doors, on the side panels and at the rear grill while the product is operating. This is normal and does not require service maintenance! Be careful when touching these areas.



**WARNING:** If the problem persists after following the instructions in this section, contact your vendor or an Authorised Service. Do not try to repair the product.

## DISCLAIMER/WARNING

Some (simple) malfunctions may be repaired by end users without creating any safety issue or causing unsafe usage provided that they are carried out under the following instructions.

(Please see the section "I Want to Repair Myself".)

**For this reason, except for parts specified at the section "I Want to Repair Myself" as could be repaired by end users, repair by an authorized service station is definitely suggested for the purpose of preventing any safety issues and this is required so that Beko product warranty may continue.**

## I WANT TO REPAIR MYSELF

Repair that will be carried out by end users can be performed within the following spare parts: Door Handles and Door Hinges, Door Joints and peripheral Trays, Baskets, Racks. (You may have access to current list of spare parts from <https://www.beko.com.tr/destek> as of 1 March 2021)

Further, in order to ensure product safety and to prevent risk of severe injuries, repair has to be carried out according to instructions from user manual or <https://www.beko.com.tr/destek>. For your own safety, please unplug product prior to carrying out any repair.

Beko may not be held responsible for safety issues that may arise because of repairs or attempts not carried out in accordance with instructions specified at user manuals or located at <https://www.beko.com.tr/destek> and performed on parts other than parts contained at current list of parts accessed from <https://www.beko.com.tr/destek>. In such a case, Beko product warranty will be invalid.

For this reason, we strongly recommend end users to avoid carrying out repairs for parts other than above-mentioned spare parts themselves and apply to an authorized service station in case of requirement. Such repair attempts by end users may cause safety issues, may damage product and may cause fire, flood, electrocution and severe personal injuries afterwards.

Including but not limited to the listed items, repairs of the following parts have to be performed by authorized service stations: Compressor, Cooling system elements, Motherboard, Inverter card, Display card, etc.

Manufacturer/dealer may not be held responsible for any circumstances where end users fail to act in accordance with the foregoing.

This product is equipped with a lighting source of the "G" energy class.

The lighting source in this product shall only be replaced by professional repairers.