



# Dishwasher

## User Manual



BDFN26530W, BDFN26530X, BDFN26531W, BDFN26531X

17 5749 0100/ EN/ AA/ 18.12.2025 18:59  
7675303977, 7675403977, 7688203977, 7688303977



## Please read this manual first!

---

Dear Customer,



Beko thank you for choosing the product. We hope that you get the best results from your product which has been manufactured with high quality and state-of-the-art technology. Therefore, please read this entire user manual and all other accompanying documents carefully before using the product.

Follow all warnings and information in the user manual. By this way, you will protect yourself and your product against possible dangers.

Keep the user manual as a reference for future use. If you handover the product to someone else, give the user manual as well. The warranty conditions, usage and troubleshooting methods for your product are provided in this manual.

### Symbols and Their Explanations

Throughout this user manual the following symbols are used:

	Danger that may result in death or injury.
	Important information or useful hints about usage.
	Read the user manual.
<b>NOTICE</b>	Danger to the product or its surroundings that may result in material damage.

<b>1 Safety Instructions</b> .....	<b>5</b>	6.12 Foldable lower basket wires .....	24
1.1 Intended Use.....	5	6.13 Tray Washing Support Piece.....	25
1.2 Child, vulnerable person and pet safety.....	5	6.14 Lower basket multi-purpose / height adjustable service shelf .....	25
1.3 Electrical safety .....	6	6.15 Bottom basket bottle wire.....	26
1.4 Transportation Safety .....	7	6.16 Upper basket multi-purpose service shelf .....	26
1.5 Installation Safety.....	7	6.17 Lower Basket Bottle and Plate Holder Part .....	27
1.6 Operation Safety.....	8	6.18 Height Adjustable Upper Basket Shelf .....	27
1.7 Maintenance and Cleaning Safety	9	6.19 Adjusting the height of the upper basket.....	27
<b>2 Environmental Instructions</b> .....	<b>9</b>	6.20 Adjusting the height of the upper basket.....	28
2.1 Compliance with WEEE Regulation and Disposal of Waste Products.....	9	6.21 Tray Washing Support Piece.....	29
2.2 Package Information.....	10	6.22 Foldable upper basket wires .....	29
2.3 Note for Test Institutes .....	10	6.23 Adjusting the height of the upper basket.....	30
2.4 Standard conformity and test information / EC declaration of conformity.....	10	6.24 Ceiling cutlery basket .....	30
2.5 This section applies for products with Wifi feature. ....	10	6.25 Ceiling cutlery basket .....	30
2.6 Energy Label .....	10	6.26 Parts that are not suitable for washing in the dishwasher.....	31
<b>3 Technical Specifications</b> .....	<b>11</b>	6.27 Lower Propeller.....	31
<b>4 General View</b> .....	<b>12</b>	6.28 Upper Propeller .....	31
<b>5 Installation</b> .....	<b>12</b>	6.29 Ceiling cutlery basket [Soft Spike]	31
5.1 Correct location for installation....	13	<b>7 Operation of the Product</b> .....	<b>32</b>
5.2 Connecting to the water supply....	13	7.1 Operating the product.....	32
5.3 Connecting to the water drain .....	14	7.2 Program information and average consumption values table .....	33
5.4 Adjusting the feet .....	14	7.3 Additional functions .....	34
5.5 Electricity connection.....	15	7.4 Functions.....	36
<b>6 Preliminary</b> .....	<b>15</b>	7.5 Starting of the programme.....	37
6.1 What to do to save energy .....	15	7.6 Cancelling the Cycle .....	37
6.2 Water softening system.....	15	7.7 End of programme.....	37
6.3 Adjusting the water softener system test strip .....	16	7.8 Low Salt Warning indicator .....	37
6.4 Setting the Water Softening System .....	16	7.9 Low Rinse Aid Warning indicator..	37
6.5 Mechanical Water Hardness Adjustment .....	17	<b>8 Maintenance and Cleaning</b> .....	<b>38</b>
6.6 Filling the salt .....	17	8.1 Maintenance and cleaning.....	38
6.7 Detergent .....	18	8.2 Cleaning the filters.....	38
6.8 Polisher .....	21	8.3 Cleaning the hose filter.....	39
6.9 Placing the dishes in the machine	22	8.4 Cleaning the propellers.....	39
6.10 Cutlery basket.....	23	<b>9 Troubleshooting</b> .....	<b>41</b>
6.11 Cutlery basket.....	24	9.1 Error Codes, Causes and Solutions .....	41
		9.2 Troubleshooting.....	41



## 1 Safety Instructions

---

This section contains safety instructions that will help protect from risk of personal injury or property damage.

Our company shall not be held responsible for any damages that may arise in case of non-compliance with these instructions.

- Installation and repair procedures must always be performed by Authorised Service Agents.
- Use only original spare parts and accessories.
- Do not repair or replace any component of the product unless it is clearly specified in the user manual.
- Do not make technical modifications to the product.

### 1.1 Intended Use

This product is intended for use in homes and in the following types of enclosed spaces: For example;

- Staff kitchens of shops, offices and other working environments;
- Farm houses;
- Areas for the use of guests of hotels, motels and other accommodation facilities;
- Places serving bed and breakfast, hostel-like environments.

- The product should only be used for household dish washing.

- The product is not suitable for commercial or public use.
- The lifetime of the product you have purchased is 10 years. This is the period for which the spare parts required for the operation of this product as defined.
- This product is intended for use in the home and under counter.

### 1.2 Child, vulnerable person and pet safety

- 8 years and older children and people with reduced physical, sensory, and mental abilities as well as unskilled or inexperienced persons can use this appliance provided that they are supervised and instructed on safe use of the appliance as well as to the related dangers.
- Children under 3 years of age should be kept away from the product unless constantly supervised.
- Children should not play with the appliance.

- Electrical products are dangerous for children and pets. Children and pets must not play with, climb on or enter into the product.
- Remember to close the door of the product when leaving the room where the product is located. Children and pets can be locked inside the product and suffocate.
- Cleaning and user maintenance must not be made by children without supervision.
- Keep the packing materials away from the children. Risk of injury and suffocation.
- Keep all detergents and additives used in the product out of the reach of children.
- For the safety of children, disconnect the power plug and break the locking mechanism before disposing of the product.
- Do not pinch the power cord under or behind the product. Do not place a heavy object on the power cord. The power cord must not be excessively bent or crushed, and must not come into contact with any heat source.
- Do not use an extension cord, multiple power outlets, or adapters to operate the product.
- Portable multiple power outlets or portable power supplies can overheat and cause a fire. Therefore, do not keep multiple power outlets behind and near the product.
- The plug must be within easy reach. If this is not possible, the electrical installation to which the product is connected must be equipped with a device (fuse, switch, circuit breaker, etc.) that complies with electrical regulations and disconnects all poles from the mains.
- Do not touch the plug with wet hands.
- When removing the plug from the socket, pull it by the plug, not by the cable.

### 1.3 **Electrical safety**

- The product must not be plugged in during installation, maintenance, cleaning, repair and transport.
- If the power cord is damaged, it must be replaced by an authorised service centre to prevent possible hazards.

## 1.4 Transportation Safety

- Before transporting the product, unplug the plug and disconnect the drain and water supply connections. Drain the water remaining inside the product completely.
- Do not carry the product alone as it is heavy.

NOTICE Do not hold the door or panel to move the product.

NOTICE If you have to move the product, move it in an upright position and hold it by the back. Tilting the product towards the front may cause the electronic parts inside to get wet and damaged.

NOTICE When putting the product in place after installation or cleaning, take care not to fold, pinch or break the hoses.

## 1.5 Installation Safety

- To make the product ready for use, check the information in the manual and installation instructions to make sure that the electrical installation, clean water installation and drainage are appropriate. Otherwise, call a qualified electrician and plumber to make the neces-

sary arrangements. These processes are at the customer's expense.

- Before installing the product, inspect the product for any damage. Do not install the product if it is damaged.
- Do not install the product in places where the temperature drops below 0 °C.
- Do not place the product on a carpet or similar surface. It causes fire risk since it cannot get air from the bottom.
- Place the product on a clean, flat and hard floor and balance it with the help of adjustable feet. If the feet are not adjusted properly, the door may not close completely and hot vapour may escape. It may cause serious burns and injuries and may also damage your furniture.
- Do not install the product near heat sources (radiators, stoves, etc.) and do not install it under the cooking area of a hob.
- If the product is intended to be used in a cupboard/cabinet/module, keep the cupboard doors open during operation if there are no gaps to ensure sufficient air circulation.

- Connect the product to an earth-grounded socket protected by a fuse rated in accordance with the current ratings indicated on the rating plate. Have the earthing installation done by a qualified electrician. Do not use the product without earthing in accordance with local/national regulations.
- Plug the product into an outlet complying with the voltage and frequency values indicated on the rating plate.
- Do not plug the product into sockets that are loose, out of the socket, broken, dirty, greasy, at risk of contact with water (e.g. water that may leak from the workbench).

**NOTICE** The new hose sets supplied with the product must be used. Do not reuse old hose assemblies. Do not splice the hoses.

**NOTICE** Connect the water inlet hose directly to the water tap. The pressure supplied from the tap must be at least 0.03 MPa (0.3 bar) and no more than 1 MPa (10 bar). If the water pressure exceeds 1 MPa (10 Bar), a pressure reducing valve must be installed. Maximum allowable water temperature is 25°C.

- Position the power cable and hoses so that there is no risk of tripping.

## 1.6 Operation Safety

Only detergents, rinse agents and additives intended for dishwashers should be used.

Never use chemical solvents in the product. These substances pose a risk of explosion.

Do not drink the wash water in your product.

Dishwasher detergents contain strong alkali, which can be extremely dangerous if swallowed. Avoid contact with skin and eyes and do not allow children near the product when the lid is open. Check that the detergent tank is empty after the wash cycle is completed.

When you pull out the upper and lower baskets completely, the door of the product takes the entire load of the baskets. Do not sit or place other loads on the door, otherwise the product may tip over.



Product's Maximum Washing capacity: Indicated on the Energy Label and Quick Use Card under Cycle Table.

To avoid possible injury, always place long and pointed dishes such as serving forks, bread knives, etc. in the cutlery basket

with the pointed end downwards or horizontally on the dishwasher baskets.

If you need to open the door while the product is running, open it carefully. Be careful of hot steam and splashes of hot water.

Do not operate a faulty or damaged product. Unplug the product (or switch off the fuse to which it is connected), turn off the water tap and call for authorised service.

Do not place a flame source (burning candle, cigarette, etc.) on or near the product. Do not place flammable/explosive materials near the product.

Do not climb on the product.

Unplug the product and switch off the tap when you will not use the product for a long time.

This product is designed to operate up to 2000 m. above sea level.

## 2 Environmental Instructions

### 2.1 Compliance with WEEE Regulation and Disposal of Waste Products

This product does not contain harmful and prohibited substances specified in the "Regulation on the Control of Waste Electrical and Electronic Equipment" published by the Ministry of Environment and Urbanisation of the Republic of Turkey. It complies with WEEE Regulation.

## 1.7 Maintenance and Cleaning Safety



Do not wash the product by spraying or pouring water on it.



Do not use sharp or abrasive tools to clean the product. Do not use materials such as household cleaning agents, detergents, gas, gasoline, alcohol, wax, etc.



Wear gloves worn when cleaning the product.



Be careful of possible injuries when cleaning sharp surfaces on the back of the product!

**NOTICE! Remember to install the filter of your machine back after cleaning it. Otherwise, the pumps may get clogged and the product may get damaged.**

### Interior Lighting



Contact a service when you need to replace the LED/bulb used for lighting according to the model of your machine.



This product is manufactured from high quality parts and materials that are recyclable and reusable. Therefore, do not dispose of the product with household or other waste at the end of its service life. Take it to a collection point for recycling electrical and electronic equipment. Ask the local authority in your area for these collection points. Help protect the environment and natural resources by recycling used products. Be-

fore disposing of the product, disconnect the power plug for the safety of children and break the locking mechanism of the loading door to render it inoperable.

---

## 2.2 Package Information

The packaging of the product is made of recyclable materials in accordance with our National Legislation. Do not dispose of packaging waste with household or other waste, dispose of it at the packaging collection points specified by the local authorities.

## 2.3 Note for Test Institutes

The information required for performance tests is available on request.

You can send your request via the e-mail address below:

dishwasher@standardloading.com

In your enquiry e-mail, be sure to include your contact details as well as the code, stock number and serial number of the product to be tested. The product code, stock number and serial number can be found on the type label attached to the side of the door

## 2.4 Standard conformity and test information / EC declaration of conformity

**CE** The development, production and sale of this product are carried out in accordance with the safety regulations of all relevant directives of the European Community.  
2014/35/EU, 2014/30/EU, 93/68/EC, IEC 60436 / EN 60436

## 2.5 This section applies for products with Wifi feature.

Frequency Band 2.4Ghz

Max. Conduction Power : < 100mW

Declaration of conformity for CE Arçelik A.Ş. hereby declares that this appliance complies with Directive 2014/53/EU. The full text of EU Conformity Declaration is on the web site:  
Products, address  
support.beko.com

## 2.6 Energy Label

 You can access technical information about the product by scanning the QR code on the energy label with a mobile device connected to the internet.



XXXXXXXXXX (\*)



### 3 Technical Specifications

Maximum washing capacity: Indicated on the Energy Label and Quick Use Card under Cycle Table.
Height:
Width:
Depth:
Electricity input:
Total power:
Heater power:
Total current: *
Pump power:
Drain pump power: *
* For detailed electrical values see the type label on the dishwasher's door.
Water Pressure 0.3 -10 bar (= 3 – 100 N/cm <sup>2</sup> = 0.03-1.0 Mpa)



Technical specifications may be amended without prior notice to improve product quality.



The figures in the manual are schematic and may not be in exact harmony with the product.



The values provided with the appliance or its accompanying documents are laboratory readings in accordance with the respective standards. These values may differ depending on the use and ambient conditions.

## 4 General View

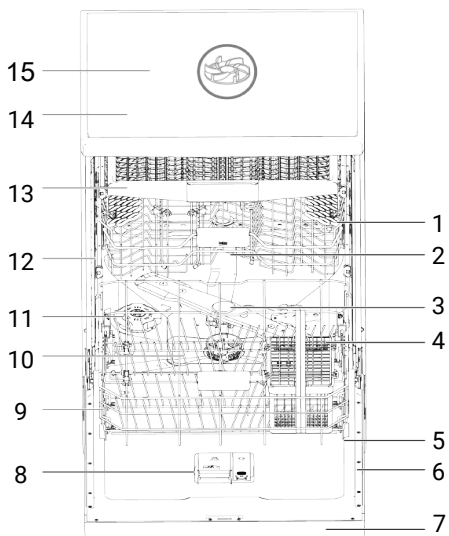

- |  |                                       |
|--|---------------------------------------|
| 1 Upper Basket                                 | 2 Upper Propeller                     |
| 3 Lower Propeller                              | 4 Cutlery Basket (depending on model) |
| 5 Door   | 6 Type Label                          |
| 7 Control Panel                                | 8 Detergent Zone                      |
| 9 Lower Basket                                 | 10 Filters                            |
| 11 Salt Compartment Cover                      | 12 Upper Basket Rail                  |
| 13 Ceiling Cutlery Basket (depending on model) | 14 Top Table (model dependent)        |
| 15 Ceiling Fan (model dependent)               |                                       |

Type label varies depending on the model.



Illustration 1:

## 5 Installation



Read the 'Safety Instructions' section first!

The preparation of the electrical, clean water and waste water installation of the place where the product will be placed is under the responsibility of the customer. Before calling the authorised service to make the product ready for use, if the electrical installation, clean water installation and water drainage are not suitable, call a qualified electrician and plumber to make the necessary arrangements.



Installation and electrical connections must be carried out by the authorised service. The manufacturer cannot be held responsible for any damages that may arise from the operations performed by unauthorised persons.



Before installing the product, inspect the product for any damage. Do not install the product if it is damaged. Damaged products pose a danger to your safety.



For free-standing and under-counter models, do not remove the kick plate of the appliance. This will void the warranty.

- When placing the product in place after installation or cleaning, make sure that the water inlet and drain hoses are not folded, pinched or broken.
- Be careful not to damage the floor, wall, pipes, etc. when placing the product. Do not hold the door or panel to move the product.

### 5.1 Correct location for installation

- There must not be any lockable, sliding or hinged doors in the place where the product is installed, which would restrict the full opening of the door.
- Place the product on a solid and level surface with sufficient load-bearing capacity! Placing the dishwasher on a level surface is essential for the door to close properly and tightly.
- Do not install the product in places where the temperature drops below 0 °C.

- Place the product on a hard floor. Do not place it on a long-pile carpet or similar surface.
- Choose a place where you can load and unload the dishes easily and quickly.
- Place the product close to the tap and drain. Choose the location of the product in such a way that you do not change it after it has been connected.



Do not place the product on the power cable. The cable may be damaged, causing a risk of electric shock or fire.

### 5.2 Connecting to the water supply

To prevent dirt (sand, clay, rust, etc.) from the city network or your water supply system from damaging the dishwasher and your dishes, we recommend installing a filter on the water inlet.

Maximum allowable water inlet temperature:

- With AquaSafe+ feature containing models, it is 60 °C.
- Up to 25 °C for other models.

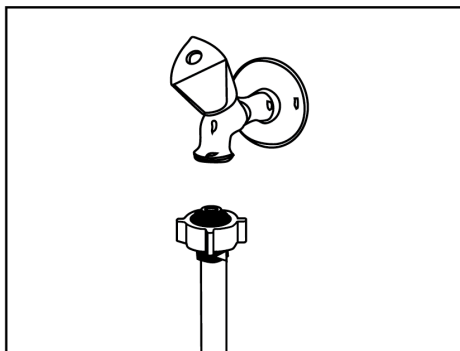

## AquaSafe+ feature

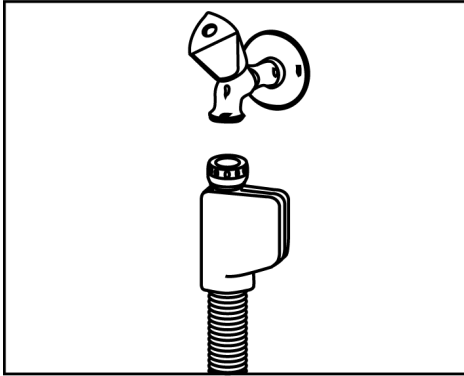

- Protect the AquaSafe+ against water leaks at the hose inlet. Water contact with the valve box of the system must be prevented. Otherwise, electrical components will be damaged.
  - Do not shorten the hose in any way or extend it with additional parts as the hose contains electrical connections and components.
  - If the system is damaged, unplug the product and call the authorised service.
- The dishwasher must not be connected to warm water appliances or running water heaters.

**NOTICE** Do not use an old or used water inlet hose on a new product. Use the new water inlet hose supplied with the dishwasher. Do not splice the hoses.

**NOTICE** Connect the water inlet hose directly to the water tap. The pressure supplied from the tap must be at least 0.3 and no more than 10 bar. If the water pressure exceeds 10 Bar, a pressure reducing valve must be installed.

**NOTICE** The water supply and drain hose must be securely fastened and undamaged.

**NOTE** After making the connections, open the tap fully and check for water leaks.

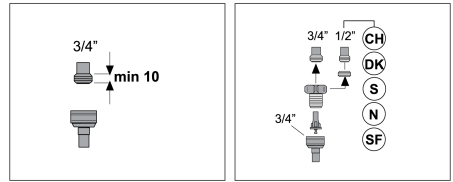

## 5.3 Connecting to the water drain

The water drain hose can be connected directly to the waste water drain or to the drain of the sink. For more detailed information, refer to the installation instructions supplied with your dishwasher.

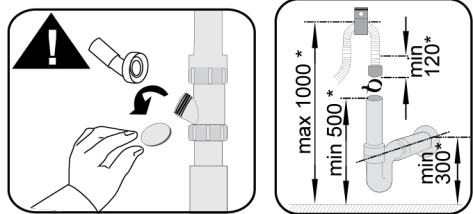
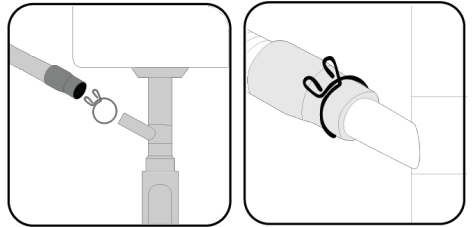

\* mm

The waste water drain must be connected to the sewer and must not be connected to surface water.

## 5.4 Adjusting the feet

If the door of the product does not close properly or shakes when you push it gently with your hand, this means that the feet are not adjusted. Adjust the feet of the product as shown in the installation manual supplied with the product.



Hot steam may escape if the dishwasher door is not adjusted properly. Serious burns can cause injury and damage your furniture.

## 5.5 Electricity connection



Connect the product to a grounded socket protected by a fuse in accordance with the values in the "Technical specifications" table. Our company shall not be responsible for any damages that may occur if the product is used without grounding in accordance with local regulations.

- The connection must comply with national regulations.

- The plug of the power cord must be easily accessible following the installation.
- Connect the product to a grounded socket protected by a 16 ampere fuse.
- The specified voltage must be equivalent to your mains voltage.



Do not connect with extension cords or multiple sockets.



A damaged power cord must be replaced by authorised service.

## 6 Preliminary



Read the "Safety Instructions" section first!

### 6.1 What to do to save energy

The following information will help you use the product in an ecological and energy-saving way.

Clean all the coarse waste on the dishes before placing them in the machine.



It is not recommended to pre-clean the dishes before loading them into the machine as this will cause energy and water consumption.



Washing dishes with a dishwasher consumes less energy and water than washing them by hand.

After the machine is fully filled, start it.

When choosing a program, pay attention to the "Program Information and Average Consumption Values Table".

Do not use more detergent than recommended on the detergent packaging.

### 6.2 Water softening system

The machine has a special water softening system that reduces the hardness of the mains water. This system softens the water to the required level to wash the dishes to the desired quality.



If the tap water hardness is over 7°dH, it should be softened. Otherwise, hardness ions will accumulate on the washed items and may affect the washing, polishing and drying performance of the machine.

### Adjusting the water softener system

When the water softening system is adjusted correctly, washing efficiency will increase.

Read the section on adjusting the water softener system first.

The regeneration of the water softening system can be carried out in all programs during the drying step. When the regeneration process is performed, the duration, energy and water consumption of the program increase. For the regeneration process; when the dishwasher is operated with a water supply of 14 dH under standard conditions in the Eco 50°C program, the frequency of the regeneration process, maximum additional time, water and energy consumption depending on the water consumption of the Eco 50°C program are given in the table below.

Eco 50°C water consumption (l)	... cycle then renewal	Additional time (min)	Additional water consumption (l)	Additional energy consumption (kWh)
12.3-14.7	5	5	3.0	0.05
9.6-12.2	6	5	3.0	0.05
9.0-9.5	7	5	3.0	0.05
8.0-9.0	8	5	3.0	0.05
7.0-7.9	9	5	3.0	0.05

For water consumption in the Eco 50°C program of your dishwasher, please refer to the Program Information and Average Consumption Values Table given in the Program Table.

### 6.3 Adjusting the water softener system test strip

When the water softening system is adjusted correctly, the washing, rinsing and drying performance of your dishwasher will increase.

To adjust the system, first find out the water hardness in your area and adjust as indicated below.

- Remove the test strip from its packaging.
- Turn on the tap and let the water run for about 1 minute.
- Dip the test strip in water for 1 second.
- Remove the strip from the water and shake it. Wait 1 minute.
- Make the necessary adjustments based on the test strip.



### 6.4 Setting the Water Softening System



Setting the water softening system correctly will improve your dishwasher's washing, rinsing, and drying performance.

**NOTICE! To set the system, first find out your water hardness level from the authorised service in your region and set it as follows.**

After determining the water hardness:

1. After switching on your dishwasher with the On/Off button, enter the Settings menu by pressing the Settings button for 3 seconds depending on the model or by pressing the On/Off and P2 program buttons simultaneously for 3 seconds.
2. Navigate to the "r" position on the screen by pressing the P2 key.
3. Set the correct level by selecting one of the "r:1", "r:2", "r:3", "r:4" or "r:5" positions with the P3 program key.
4. To save, exit the settings menu by pressing on/off button of your dishwasher for 3 seconds. Your settings will be saved automatically.

Hardness Level	English Hardness °dE	German Hardness °dH	French Hardness °dF	Water Hardness Level Indicator
0. Level 	0-5	0-4	0-8	Bring the water hardness setting to position 1 by pressing the Select key. (r1)
1. Level 	6-9	5-7	9-13	Bring the water hardness setting to position 1 by pressing the Select key. (r1)
2. Level 	10-15	8-12	14-22	Bring the water hardness setting to position 2 by pressing the Select key. (r2)

3. Level 	16-19	13-15	23-27	Bring the water hardness setting to position 3 by pressing the Select key. (r3)
4. Level 	20-24	16-19	28-34	Bring the water hardness setting to position 4 by pressing the Select key. (r4)
5. Level 	25-62	20-50	35-90	Bring the water hardness setting to position 5 by pressing the Select key. (r5)

**Table 1: Water Hardness Level Setting Table**

- If the hardness of the water you use is above 50°dH (French hardness) or if you use well water, you should use filters and water purifiers.
- If the hardness of the water you use is below 7°dH, you do not need to use salt in your dishwasher. In this case, the "Low Salt Indicator Light" on your dishwasher control panel will be on continuously.
- If your water hardness setting is at level 1, the "Low Salt Indicator Light" will remain on continuously even though you do not need to use salt. If you do add salt in this position, the salt will not be consumed and the lamp will not come on.

**NOTICE! If you move house, you may need to adjust the water hardness setting of your dishwasher again according to the water hardness of the place you move to, taking into account the information given above. If the water hardness setting of your dishwasher has been adjusted before, the last water hardness setting will be displayed on your dishwasher's display panel.**

## 6.5 Mechanical Water Hardness Adjustment

(model dependent)

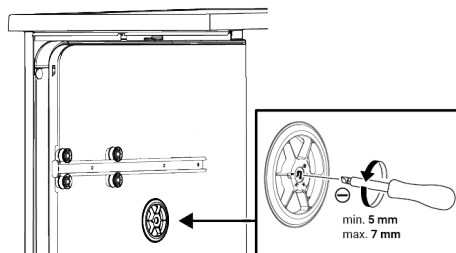

If your product has a glass care function setting, it is used to adjust the water hardness level of the pre-softened wash water in the dishwasher. This setting should be made according to the water hardness setting level. Adjustment is made using a wide, flat screwdriver. The screwdriver is used to turn the mechanical glass care adjustment switch. Simply set the mechanical switch to the same position as the water hardness setting level.

For example

For water hardness level "r3", set the Mechanical Glass Care setting switch to position 3

For water hardness level "r4", set the Mechanical Glass Care setting switch to position 4

Make the same hardness level that you set on the control panel with the regeneration setting switch. For example, if the setting you made on the control panel is 3, set the regeneration setting switch to 3 as well.

## 6.6 Filling the salt

In order for the machine to operate at the same performance continuously, the water softening system needs to be renewed. Dishwasher salt is used for this purpose.

**i** Use only special softening salt produced for use in dishwashers.

**i** It is recommended to use granulated or powdered softening salts in the water softening system. Do not use table salt, rock salt, etc. that do not fully dissolve in water. Otherwise, the performance of the system may deteriorate over time.

**i** The salt compartment fills with water when you turn the machine on, so fill the salt compartment before starting the machine.

1. To add softening salt, first remove the lower basket.
2. Open the salt compartment cover by turning it counterclockwise (A).

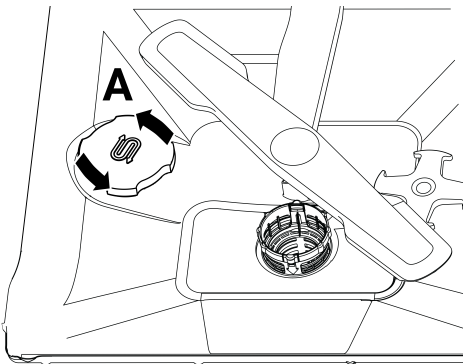

3. Add 1 litre of water to the salt compartment only when using your machine for the first time.
4. Fill the salt container with salt (D). Stir with a spoon to speed up the dissolution of the salt in the water.

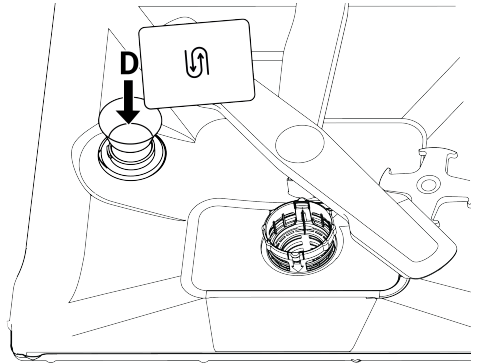

**i** You can put about 2 kg of softening salt into the salt compartment.

5. Once the compartment is full, replace the cap and turn it.

**i** Salt should be added just before starting the machine. In this way, the overflowing salt water is cleaned immediately and the risk of corrosion inside the machine is prevented. If you are not going to wash immediately, run your machine empty and without detergent in the shortest program.

**i** Depending on the different brands of salt in the market and the water hardness, it may take several hours for the salt to dissolve in water. Therefore, after the salt is filled into the machine, the "Salt Deficiency Warning Indicator" will continue to light for a certain period of time.

## 6.7 Detergent

You can use powder, liquid/gel and tablet detergent in the dishwasher.



Use only detergents designed for use in dishwashers. We recommend that you do not use detergents containing chlorine or phosphates, as they are harmful to the environment.

- Do not use expired detergents.

- Do not use other cleaning materials other than powder/liquid or tablet detergent types.

### Filling the detergent

To obtain good washing and drying results, pay attention to the warnings given on the detergent packaging. For additional questions, please contact the detergent manufacturer.



Do not put solvents in the detergent compartment. There is a risk of explosion!

Put the detergent into the detergent compartment just before starting the machine as follows.

1. Open the detergent compartment cover by pushing the latch to the right (A).  
(depending on model)

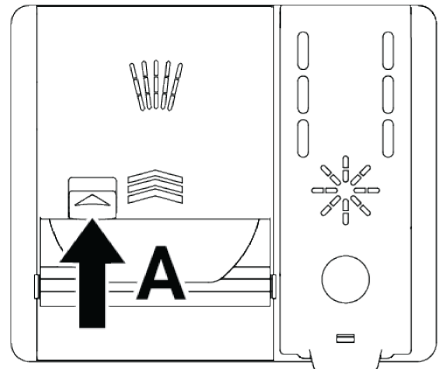
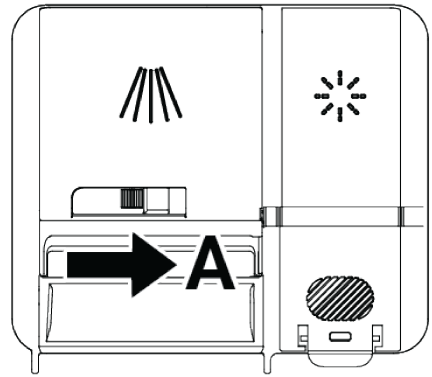

2. Put the specified amount of powder, liquid/gel or tablet detergent into the compartment.



There are level lines inside the detergent compartment to help you use the right amount of powder detergent. When the detergent compartment is full, it takes 45 cm<sup>3</sup> of detergent. Depending on the filling level of the machine and / or the dirtiness of your dishes, fill the detergent compartment up to the 15 cm<sup>3</sup> or 25 cm<sup>3</sup> level lines. In case of tablet detergent, one tablet is sufficient.

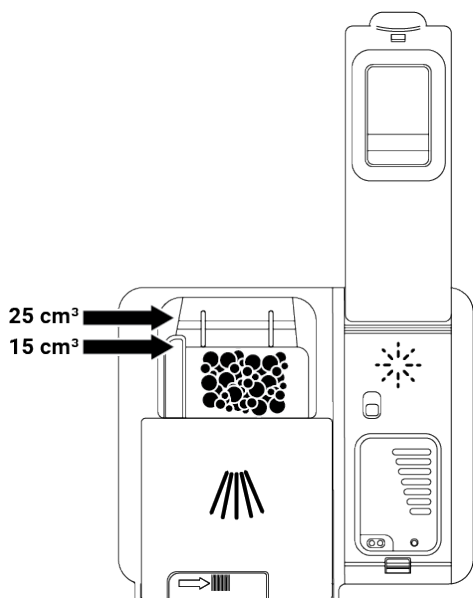

3. Close the detergent compartment cover by pushing it in the direction of the arrow. A "click" sound will be heard when the cover is closed.

**1**

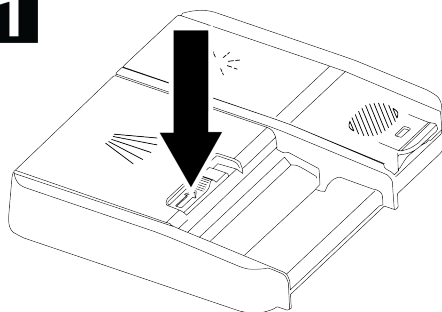

**2**

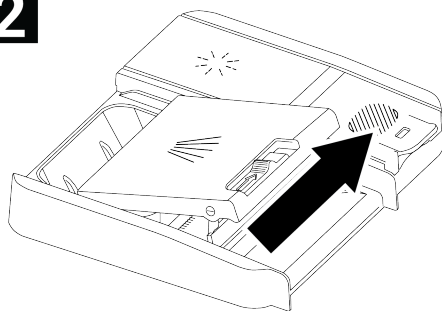

**3**

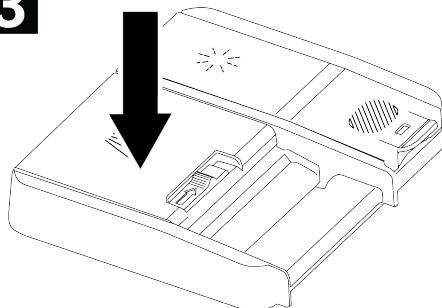

Since the solubility of tablet detergents varies depending on temperature and time, be sure to use powder or liquid/gel detergent in short programmes without pre-washing.

### Tablet Detergents

In addition to classic tablet detergents, there are also tablet detergents on the market that contain water softening salt and/or rinse aid. Some also contain special components such as glass protector and stainless steel protector. These tablets work up

to a certain water hardness level (21°dH). Above this level, water softening salt and rinse aid should be used together with the tablet detergent.

The best washing performance in dishwashers is achieved by using detergent, rinse aid and water softening salt separately.

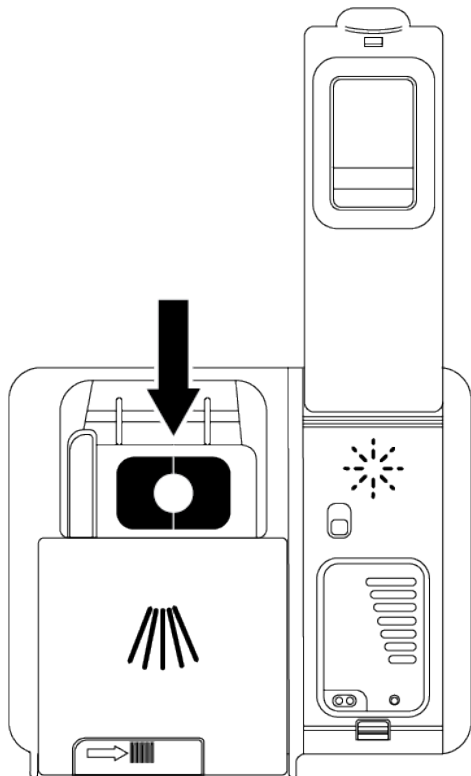

When using tablet detergents, follow the manufacturer's instructions on the detergent packaging.

If your dishes are wet when the wash cycle ends and/or you see limescale stains, especially on your glasses, contact the detergent manufacturer.

#### **When you switch from tablet detergent to powder detergent:**

- Make sure the salt and rinse aid compartments are full.
- Set the water hardness setting to the highest position and run a wash program with the machine empty.

- After an empty wash, readjust the water hardness setting appropriate for your tap water by referring to the user manual.
- Adjust the rinse aid setting appropriately.

## **6.8 Polisher**

The rinse aid used in dishwashers is a special compound designed to increase drying efficiency and prevent water or limescale residues from remaining on the washed items. Therefore, care should be taken to ensure that there is rinse aid in the rinse aid compartment and that only rinse aids produced for use in dishwashers should be used.

### **Filling the rinse aid**

1. Open the rinse aid lid using the latch.

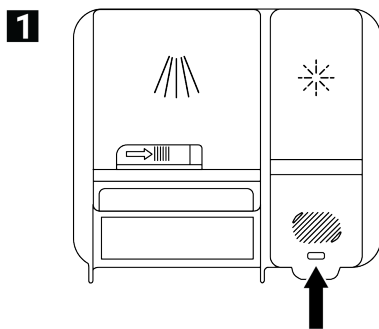

2. Fill the compartment to the MAX level.

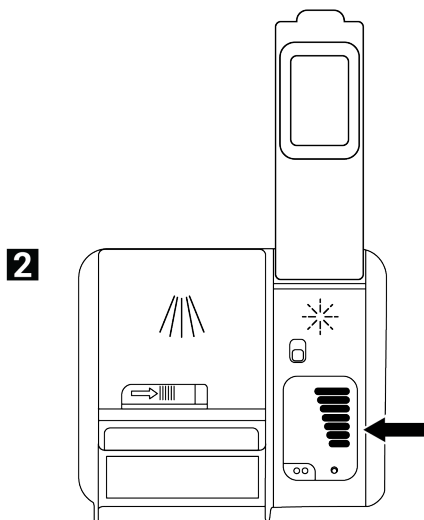

- Close the compartment lid by pressing it gently.

**3**

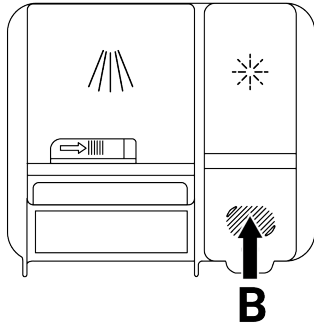

- If there are water marks on the dinnerware after washing, it is necessary to increase the degree of the adjuster, and if a blue mark remains when wiped by hand, it is necessary to decrease it. This setting is set to position 3 when leaving the factory.



Rinse aid settings are explained under the heading "Adjusting the amount of rinse aid" in the operating section of the machine.



Wipe off any rinse aid that spills outside the compartment. Rinse aid accidentally spilled will cause foaming and reduce washing performance.

## 6.9 Placing the dishes in the machine

If you place the dishes correctly in accordance with the washing capacity of your dishwasher, you will use the machine in the best way in terms of energy consumption, washing and drying performance.

- Before placing your dishes in the machine, scrape off any food residue (bones, fruit seeds, etc.) on them.
- If possible, place thin, narrow-bodied pieces in the middle compartments of the baskets.
- Place very dirty and large items in the lower basket and small, delicate and light items in the upper basket.

- Place deep containers such as bowls, glasses, and pots with their mouths facing downwards. This will prevent water from accumulating in them.



To prevent possible injuries, always place long and sharp dishes such as serving forks, bread knives, etc. in the cutlery basket with their sharp points facing downwards or horizontally on the dish baskets.

First empty the dishes in the lower basket, then the dishes in the upper basket.

### Alternative Basket Layout Examples

#### Lower Basket

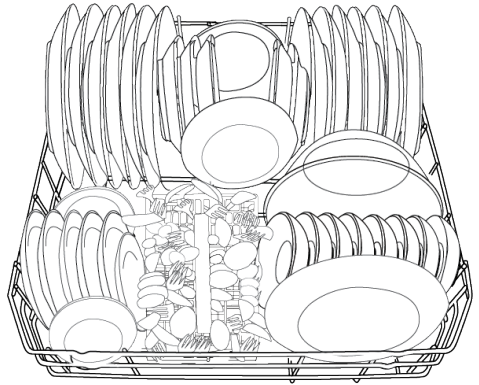

#### Upper Basket

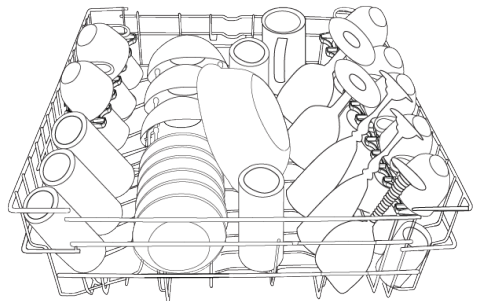

## Incorrect Placements

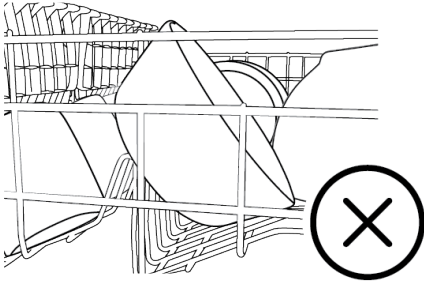
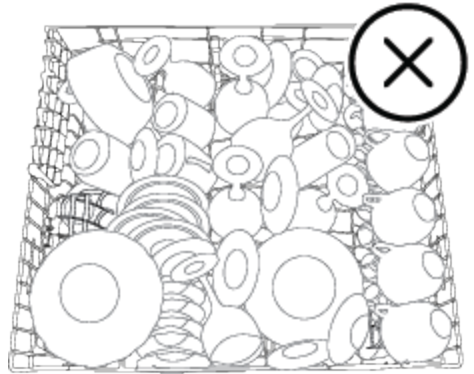
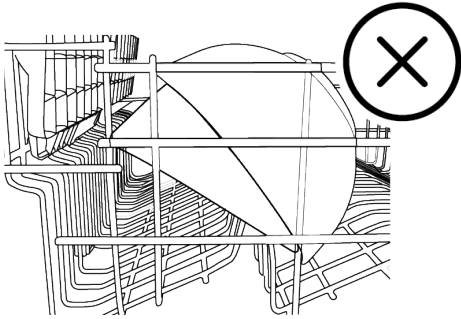
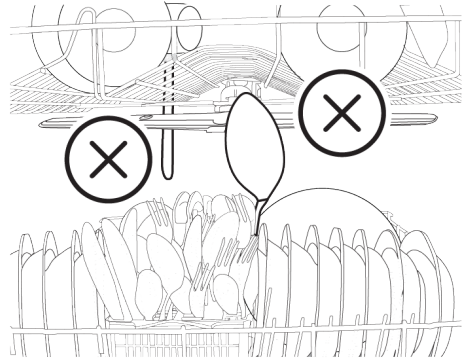
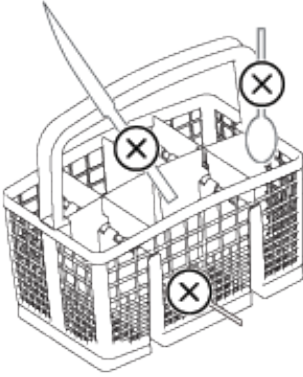

### 6.10 Cutlery basket

(model dependent)

The cutlery basket is specially designed to wash your dishes such as knives, forks, spoons, etc. more cleanly.

Thanks to the movable (A, B) feature of the cutlery basket, you can create larger areas and make room for dishes of different sizes when placing your dishes in the lower basket.

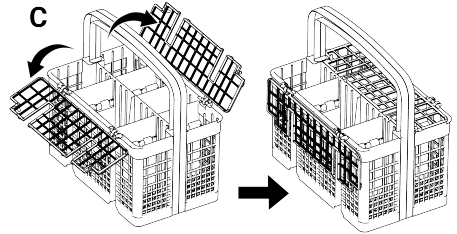
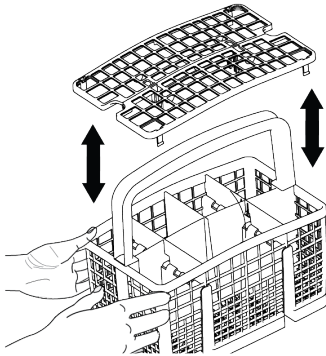
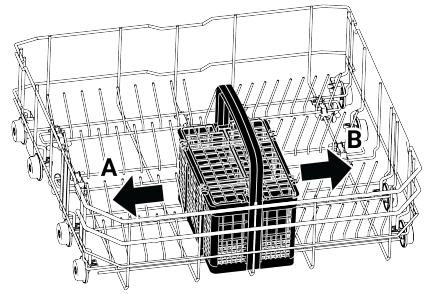
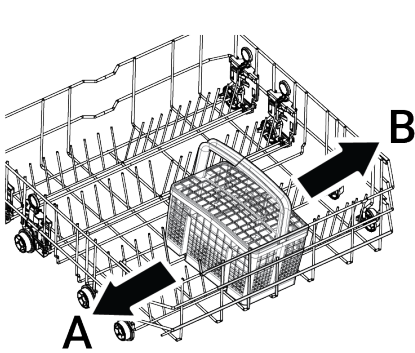

## 6.11 Cutlery basket

(Depending on model)

The cutlery basket is specially designed to wash your dishes such as knives, forks, spoons, etc. more cleanly.

Thanks to the movable feature of the cutlery basket (A, B), you can create larger areas when placing your dishes in the lower basket and make room for your dishes of different sizes. If you want to place more cutlery, you can fold the separators to the side. (C)

## 6.12 Foldable lower basket wires

(Depending on model)

The six-piece (A) folding wires located in the lower basket of the machine are designed to allow you to place large items such as pots, bowls, etc. more easily. If you wish, you can create larger areas by folding each piece individually or all at once.

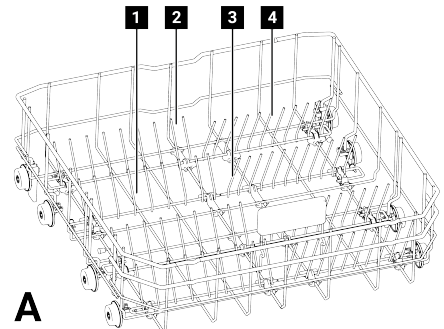

To put the foldable wires in a horizontal position, hold the wires in the middle and push them in the direction of the arrows (B). To put the wires back in an upright position, lift them up. The foldable wires will fit back into the latch (C).

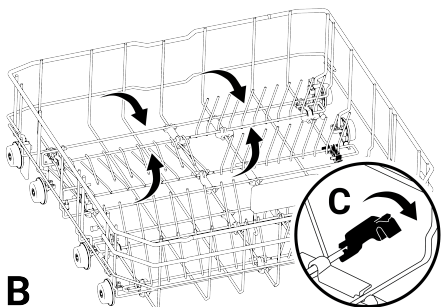

**B**



Holding the wires from the ends and placing them in a horizontal position may cause them to bend. For this reason, hold the wires in the middle from their bases and push them in the direction of the arrow, placing them in a horizontal or vertical position.

### 6.13 Tray Washing Support Piece

(Depending on model)

Use the support pieces to wash trays in your lower basket.

For appropriate program and function selection, see the Additional functions section.

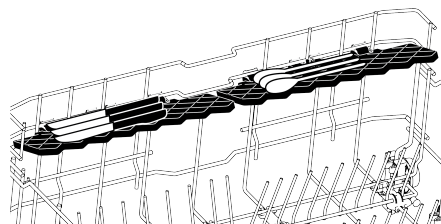
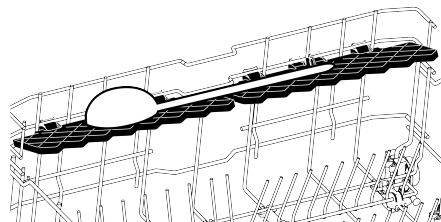
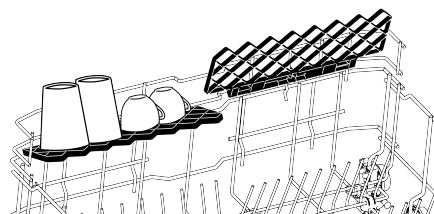

You can use the shelves as you wish by positioning them up or down, or you can close them to create ample space in your lower basket.



Make sure the fan does not hit the dishes you place on the shelves.

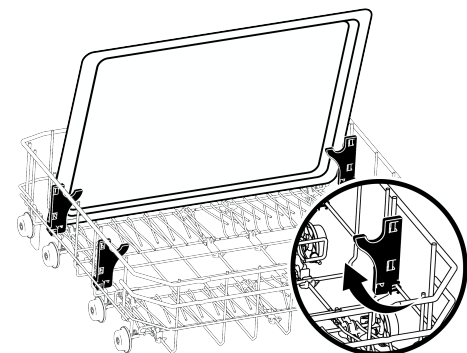

Illustration 2:

### 6.14 Lower basket multi-purpose / height adjustable service shelf

(model dependent)

To bring the shelves into closed position;

1. Fold the shelf (A).
2. Slide the shelf up (B).
3. Place the shelf in the upright position (C).
4. Slide the shelf down and lock it using the tabs (D).

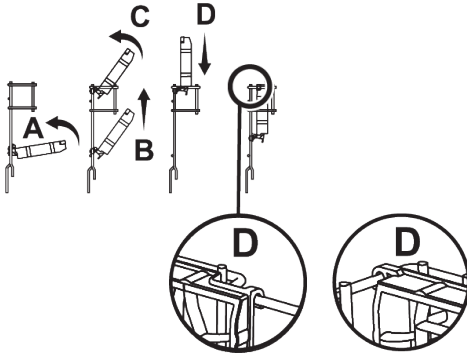

**i** You can turn the shelf into open position by doing the same process in reverse.

To adjust the height of the shelves:

1. Fold the shelf (E).
2. Slide the shelf up (F).

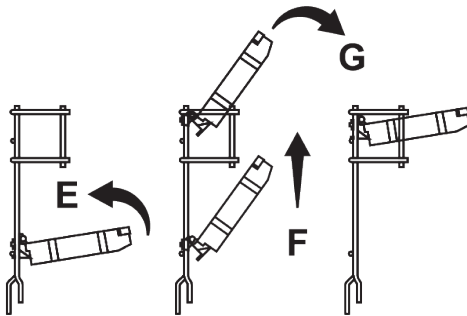

3. Open the shelf to the desired level (G).

### 6.15 Bottom basket bottle wire

(Depending on the model)

The bottle wire is designed to help you wash wide-mouthed and tall items more easily. When you are not using the bottle wire, you can remove it from your basket by pulling it outwards from both sides (H).

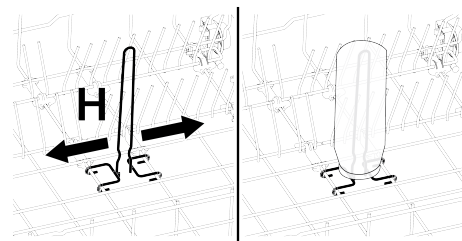

### 6.16 Upper basket multi-purpose service shelf

(Depending on the model)

Thanks to the multi-purpose service shelf in the upper basket of your machine, long service and kitchen utensils can be easily loaded and washed. In addition, the glass foot fixing sections located at the front of this accessory help to place glasses of appropriate size in the upper basket more easily.

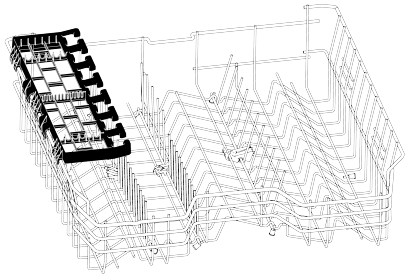

When you do not want to use it, you can remove the upper basket multi-purpose service shelf by lifting it up.

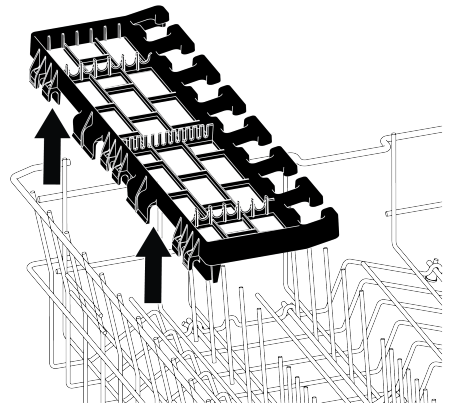

You can easily attach the upper basket multi-purpose serving shelf to the edge of your upper basket for reuse.

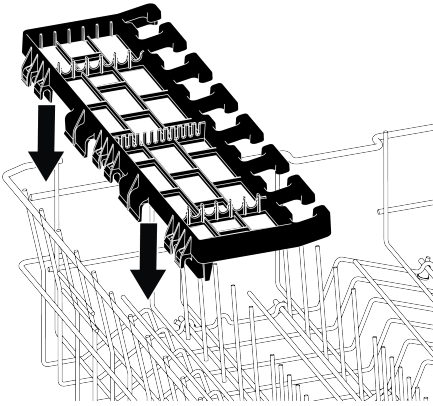
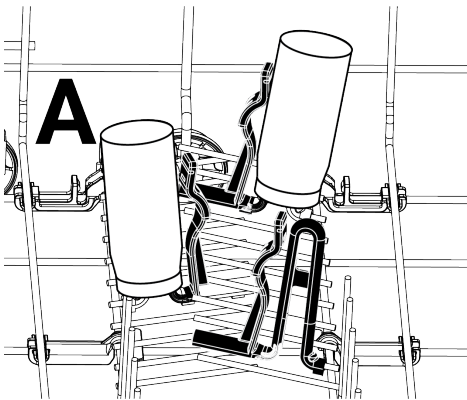

Illustration 3:

### 6.17 Lower Basket Bottle and Plate Holder Part

(Depending on the model)

The lower basket bottle and plate holder part (A) is designed to help you wash your narrow-mouthed and tall dishes more easily. After bringing the foldable wires to the horizontal position, you can place your bottles on the bottle holder parts. Secure your bottles by tightening them onto the bottle holder clip part, as in the image below.



When you put the foldable wires in an upright position, you can place your plates without removing the holder parts.

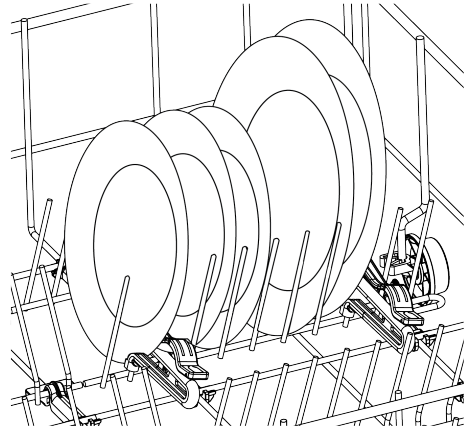

**i** Holding the wires from the ends and placing them in a horizontal position may cause them to bend. Therefore, it would be appropriate to hold the wires in the middle from their bases and place them in a horizontal or vertical position.

### 6.18 Height Adjustable Upper Basket Shelf

(model dependent)

You can use the height-adjustable shelves in the upper basket of the machine as you wish by moving the lower and upper parts up or down according to the height of the glasses, cups, etc. (A, B, C).

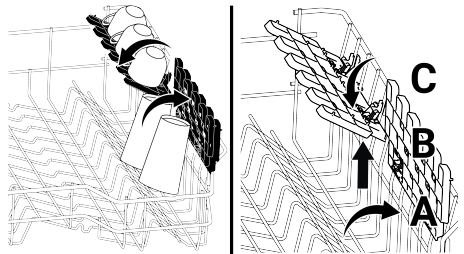

### 6.19 Adjusting the height of the upper basket

(model dependent)

The upper basket height adjustment mechanism is designed to create large areas in the upper or lower areas of the machine ac-

ording to your needs by adjusting the height up or down when your basket is empty or full.

With this mechanism, you can use your basket in three different positions: bottom, middle and top.

1. To raise your basket, hold the upper basket wires with both hands and pull upwards while the basket is in its lowest position (A).
2. Release the basket when you hear a "Click" sound coming from the right and left mechanisms and the basket reaches the upper level.

If the height is not sufficient, repeat the same process.

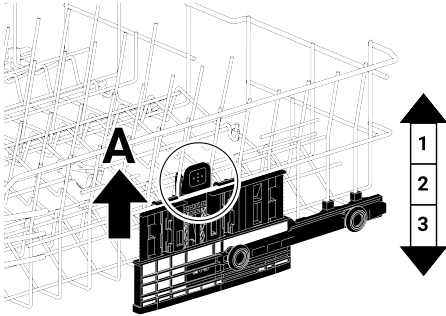

To lower the basket while it is in the top position;

1. Hold the upper basket wires with both hands, lift the basket up a little, and press and release the latches (B) shown in the figure at the same time.
2. Lower the basket from its current position to the lower position.
3. Once your basket reaches the lower level, release the basket.

If the height is not sufficient, repeat the same process.

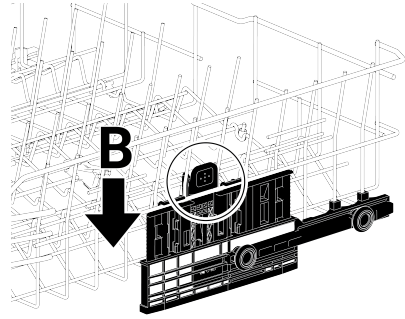

**i** The movement mechanism may not work properly if the upper basket is overloaded or the weight distribution is not balanced. In heavier conditions, there is a risk of falling to the lower level.

**i** Make sure that the adjustment mechanism is in the same position on the right and left of the upper basket.

## 6.20 Adjusting the height of the upper basket

(Depending on the model)

The upper basket height adjustment mechanism is designed to create large areas in the upper or lower areas of the machine according to your needs by adjusting the height up or down when your basket is empty or full.

With this mechanism, you can use your basket in three different positions: bottom, middle and top.

To lower the basket while it is in the top position;

1. Hold the upper basket wires with both hands and lift the handle on the mechanism upwards as shown in the figure (A).
2. Lower the basket from its current position to the lower position.
3. Once your basket reaches the lower level, release the basket.

If the height is not sufficient, repeat the same process.

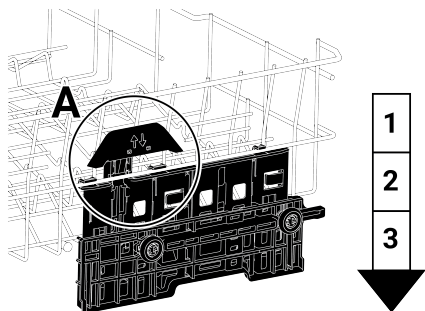

1. To raise your basket, hold the upper basket wires with both hands and pull upwards while the basket is in its lowest position (B).
2. When the basket reaches the upper level with a "Click" sound coming from the right and left mechanisms, release the basket.

If the height is not sufficient, repeat the same process.

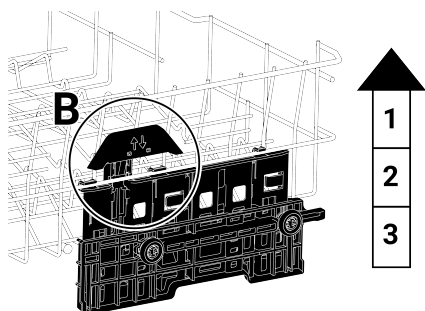

**i** The movement mechanism may not work properly if the upper basket is overloaded or the weight distribution is not balanced. In heavier conditions, there is a risk of falling to the lower level.

**i** Make sure that the adjustment mechanism is in the same position on the right and left of the upper basket.

## 6.21 Tray Washing Support Piece

(Depending on the model)

If you want to wash trays in your lower basket, you can use tray washing support parts.

For appropriate program and function selection, see the Additional functions section.

When you are not using the piece, you can fold it to place your dishes easily.

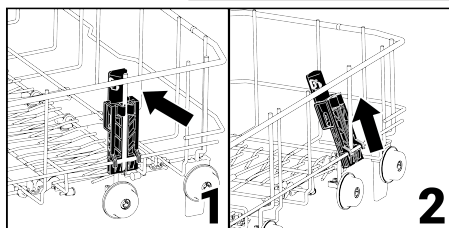
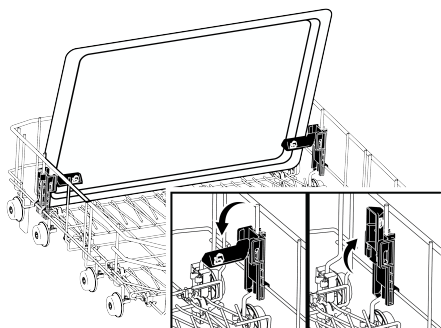

If necessary, you can remove the part as shown in pictures 1 and 2.

In the performance control tests to be carried out according to the standards, the tray washing support parts must be removed as indicated in pictures 1 and 2.

## 6.22 Foldable upper basket wires

(Depending on model)

When you need ample space for your large dishes in the upper basket of the machine, you can use the foldable wires.

To bring the foldable wires to a horizontal position, hold the wires in the middle and push them in the direction of the arrow in the picture. Place your large dishes in the area that will be created. Lift the wires up to bring them back to an upright position.

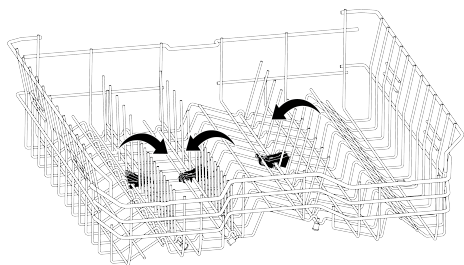

**i** Holding the wires from the ends and placing them in a horizontal position may cause them to bend. For this reason, hold the wires in the middle from their bases and push them in the direction of the arrow, placing them in a horizontal or vertical position.

### 6.23 Adjusting the height of the upper basket

(Depending on the model)

Place large items such as pots etc. in the lower basket. You can adjust the height of the upper basket according to the size of the dishes you will wash. To change the height of the basket, use the basket wheels, turn the holders at the end of the upper basket rails to the sides and open them, take the basket out. Change the position of the wheels, place the basket back on the rail and close the holders.

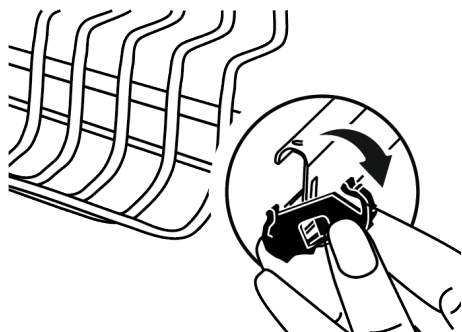

### 6.24 Ceiling cutlery basket

(Depending on model)

The ceiling cutlery basket is designed for you to wash your dishes such as forks, spoons, etc. by placing them between the combs on the tray.

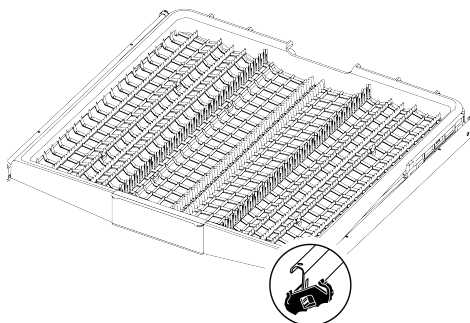

### 6.25 Ceiling cutlery basket

(Depending on the model)

The ceiling cutlery basket is designed for you to wash your dishes such as forks, spoons, etc. by placing them between the combs on the tray.

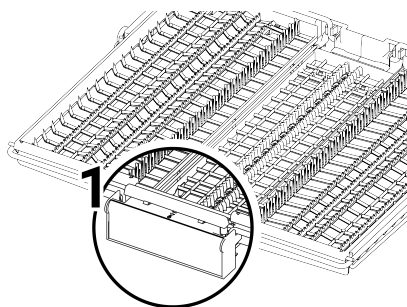
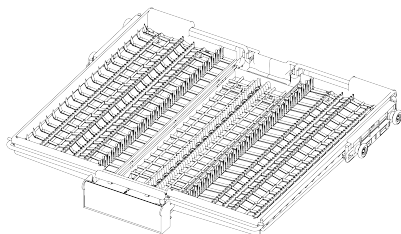

In models with partial movement feature, by pushing the lever (1) located on the handle, the tray in the middle part of the basket lowers to the lower position and the right and left side trays can be used movably by unlocking the system.

The space vacated by the side trays allows tall items to be loaded in the upper basket.

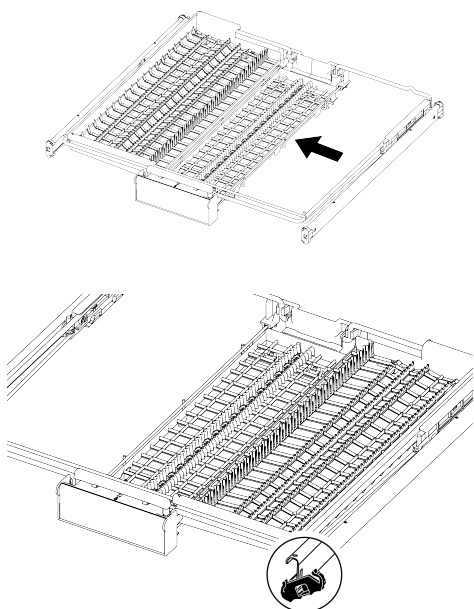

When the middle tray is in the lower position, high dishes such as coffee cups, ladles, etc. can be loaded onto the tray. When the side trays rest on the two edges, the handle can be pulled to lift the middle tray up and lock the system.

### 6.26 Parts that are not suitable for washing in the dishwasher

- Never wash dishes contaminated with cigarette ash, candle residue, polish, paint, chemicals, etc. in the machine.
- Do not wash forks, spoons and knives with wooden or bone handles, glued parts, plastic parts that are not heat-resistant, copper and tin containers in the machine.



Dishwasher-safe, as with hand washing, can cause discoloration and tarnishing of decorative prints on porcelain, aluminum, and silver. Some delicate glass and crystal types can lose their transparency over time. We recommend that you pay particular attention to whether the new tableware you purchase is dishwasher-safe.

### 6.27 Lower Propeller

The lower impeller washes the dishes in the lower basket.

### 6.28 Upper Propeller

The upper fan washes the dishes in the upper basket.

### 6.29 Ceiling cutlery basket [Soft Spike]

(model dependent)

The combs are optimized on the cutlery tray to specifically support forks, spoons and knives, with symbols indicating which type should ideally be placed in which part of the tray.

The left tray can be moved up and down by pulling or pushing down on the handle. When in the lower position, cups can be placed on this tray for added flexibility.

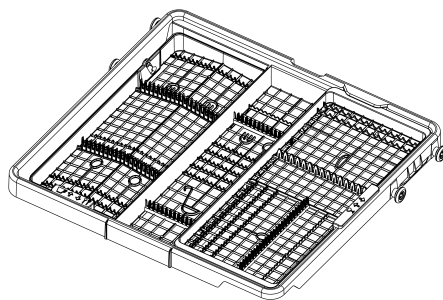

*Illustration 4:* The right tray is free to move laterally. When the right tray is moved to the left, it creates extra space underneath

to allow larger glasses to be placed in the upper basket and is supported by a soft spike.

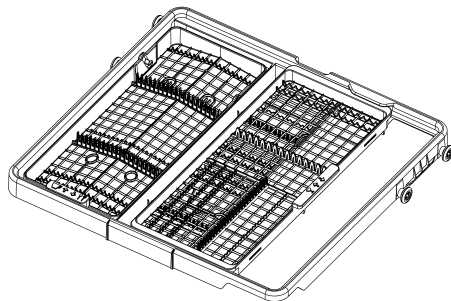

## 7 Operation of the Product

### 7.1 Operating the product

Read the chapter "Safety Warnings" first!

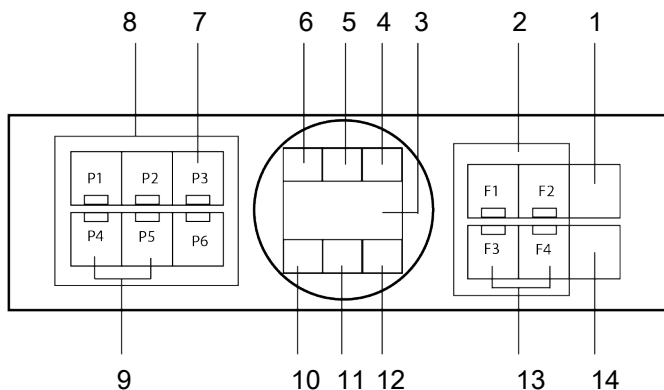

- |   |                                  |
|---|----------------------------------|
| 1 On / Off Button   | 2 Function Selection Buttons     |
| 3 Display   | 4 Program Working Indicator      |
| 5 Low Rinse Aid Warning Indicator   | 6 Low Salt Warning Indicator     |
| 7 Settings Selection Key / Program Key<br>(Key led is inactive when used for settings.) | 8 Program Selection keys         |
| 9 Child (Button) Lock Function  | 10 Child (Button) Lock Indicator |
| 11 Not in use   | 12 Auto Door Opening Indicator   |
| 13 Auto Door Opening Function   | 14 Start / Hold / Cancel Key     |

#### Power On/Off Button

Do not touch the display with wet hands.

When you press the Power On/Off button, the screen indicator lights turn on in the ON position. They will go out when the dishwasher is off.

### Cycle Selection/Cancel Cycle Button

Select the cycle that you want to run from the "cycle selection keys" and press the key.

Press the Start / Hold / Cancel key for 3 seconds to cancel the running program

After the 3 - 2 - 1 countdown, the display will show 0:01 and the discarding process begins. Discarding process will be completed within 2 minutes and your dishwasher will beep when it is done.

### Function Buttons

When the Function Buttons are pressed during cycle selection or delay selection, if the cycle you selected supports the function you have selected, a positive button warning sound will be heard. When the indicator for the selected function is lit, this means the function has been selected.

To cancel function selection, press and hold the function button again until the function indicator turns off.

### Preparing the dishwasher

1. Open the door of the dishwasher.
2. Load your dishes as described in the user manual.
3. Ensure that lower and upper spray arms are rotating freely.
4. Put a suitable amount of detergent in the detergent reservoir.

### Cycle selection

1. Turn your dishwasher on by pressing the On / Off button.
2. Inspect low salt and low rinse aid indicators and add salt and/or rinse aid if required.
3. Select the proper washing cycle for your dishes considering the cycle information and average consumption values table.
4. When you press the Start/Pause/Cancel button of your dishwasher, the selected program starts.

## 7.2 Program information and average consumption values table

**Programme Data and Average Consumption Values Table**

Programme number	0	1	2	3	4	5	6
Programme name	-	Auto	Intensive	Eco *	Delicate	Quick&Shine (#)	Mini (#)
Cleaning temperature	-	40-65 °C	70 °C	50 °C	40 °C	60 °C	35 °C
Degree of Soiling	-	Determines the soiling degree of the dishes and sets the temperature and amount of the washing water as well as the washing time automatically. Suitable for all types of dishes.	Suitable for heavily soiled dishes, pots and pans.	Suitable for washing dishes with normal amount of soil. It is the most efficient program in terms of combined power and water consumption. This is used for assessing the compliance with EU's eco-design directive.	Special programme for gentle cleaning of delicate glassware.	Daily washing programme for normally soiled dishes in the fastest way.	Suitable for lightly soiled daily dishes that are scraped or pre-cleaned.
Prewash	-	+	High	Medium	Low	Medium	Low
Wash	-	+	+	+	+	+	+
Dry	-	+	+	+	+	+	+
Duration (min)	-	125-181	143	245	135	58	30
Water (l)	-	10.8-14.1	15,40	9,90	13,90	10,60	10,60
Energy (kWh)	-	0.90-1,45	1,65	0,861	1,26	1,2	0,8
Selectable functions	-	T, E, R, H, K	T, E, Y, F, R, U, H, K	T, E, Y, F, S, R, U, H, K	T, E, Y, F, R, K	T, E, R, H	T, E

**Loading Capacity: 15**

The consumption values shown in the table were determined under standard conditions. Differences may therefore occur under practical conditions. \* Reference programme for testing institutes. The tests in accordance with EN 50242/60436 must be carried out with a full water softener salt dispenser and a full rinse aid reservoir, and using the test programme. The values given for programmes other than Eco 50°C programme are indicative only. (#) Additional functions might cause changes in programme durations.

### 7.3 Additional functions

The machine's washing programs are designed to achieve the best cleanliness, taking into account the type of dirt, the amount of dirt and the characteristics of the dish-ware to be washed.

Additional functions have been created to help you save time, water and energy and ensure a more hygienic and comfortable wash, thanks to your specific conditions.



Additional functions may cause a change in program duration.



Additional functions are not suitable for all wash programs. The display of the function not suitable for the program will not be active.

 The functions that can be used in the washing programs are indicated by letters such as "A, B, D, E, G, F, F, K..." in the "Program information and average consumption values table". You can find instructions on how to use these functions in the "Additional functions" section of the user manual.

 Some auxiliary functions cannot be used together. If the function you have selected is not active even though it appears in the "Program information and average consumption values table", you can activate it after turning off the other auxiliary functions.

#### **To add additional functions to the program:**

1. Select the desired wash program.
2. When you select an additional function, the indicator for the additional function lights up. When you press the function key again, the indicator goes out and the selection is canceled.

If your machine has sub-menu functions depending on the model, refer to the instructions in the additional functions section for their use.

 "Not all of the functions indicated with letters such as "A,B,D,E,G,F,K..." in the program information and average consumption values table can be used in your machine, the functions that can be used in your machine are described in the additional functions section of this manual.

#### **Self Dry Function (K)**

(Depending on Model)

Your machine is equipped with a "Self Dry" Thanks to the feature, the drying efficiency of your machine is increased and energy savings are achieved.

When you activate this function, the door of your machine opens automatically at the end of the wash cycle.

The function can extend the duration of the selected program for up to 35 minutes.

 The function can extend the duration of the selected program for up to 35 minutes.

 Self Dry feature opens the door at the end of the wash thanks to the "door opening shafts". This process takes approximately 2 minutes. Do not force the door to close if the power is cut while the spindles are coming out. When the power is restored, the process will be completed and the shafts will be pulled in.

 Self Dry If the feature is active, the door can be opened automatically during the drying step and the program flow can continue. If the product has a display, the time continues to count down with the door open until the drying is completed and the program ends.

#### **Self Dry Function**

##### **Self Dry To activate the function:**

1-When the machine is on and the door is closed,Self Dry Press and hold the F3 and F4 function keys simultaneously to activate the function.

2-Self Dry indicator lights up andSelf Dry becomes active.

 Self Dry function can be activated or deactivated in Program Select mode.

##### **Self Dry To cancel the function:**

1- While the machine is on and the door is closed,Self Dry To cancel the function, press and hold the F3 and F4 function keys simultaneously.

2-Self Dry indicator goes out and the function is deactivated.

##### **Snooze function**

(Model dependent)

If an economical electricity tariff is applied in your area, you can use the delay function to wash your dishes during the relevant hours.

You can postpone the start time of your selected program for up to 24 hours.

1. With the door closed, press the delay button after selecting the washing program and other additional functions.
2. When you press the Snooze button, "1h" will appear on the Display Information Line and the Snooze indicator will start flashing.
3. Press the snooze button to set the desired time. Each time you press the button, the time increases in 1-hour increments up to 24 hours. Pressing the snooze button for a long time will continuously increase the time.
4. Press the Start / Pause / Cancel button. The program will start automatically when the delay is over.

Changing settings while the snooze function is active

While the delay function is active, you cannot make changes to the washing programme, additional functions or the delay time.

 Once the program has started, the program and auxiliary functions cannot be set/changed.

### To cancel the snooze function

While the door is closed and the machine is on, press the Start / Pause / Cancel button for 3 seconds. When the delay function is cancelled, the program selection mode is returned.

 In some models, the delay function is performed via the Homewhiz application. After selecting the program via the application, you can adjust the delay time by clicking on the delay time icon at the bottom.

### Child (Key) Lock Function (Depending on Model)

You can prevent anyone other than you from affecting or changing the program flow and delay time while the machine is operating.

To enable child lock:

1. With the machine on and the door closed, press and hold the P4 and P5 program buttons simultaneously to activate the Child (Key) Lock function.
2. The child (key) lock indicator lights up and the key lock is activated.

 Child lock prevents the selected functions from being changed and disables the Start / Pause / Cancel button.

 The child lock does not lock the door of the machine.

 If you turn off your machine with the On / Off button, the child lock is automatically deactivated.

To cancel child lock:

1. With the machine on and the door closed, press and hold the P4 and P5 program buttons simultaneously to cancel the Child (Key) Lock function.
2. The child (key) lock indicator goes off and the key lock is cancelled.

## 7.4 Functions

### Hygiene Intense function (H)

(Depending on the model)

Ideal for enhanced dishwashing hygiene. This function increases washing and rinsing temperatures, extends program duration, and adds an extra rinse cycle for superior sanitation.

If the Automatic Door Opening feature is active on some products, function Hygiene Intense can be selected.

### Half Load function (Y)

(Depending on the model)

It is used when you want to start your machine before it is full.

1. Load dishes into the dishwasher as desired.

2. Turn the machine on using the On/Off button.

3. After selecting the program you want, press the Half Load button.

4. Press the Start/Pause/Cancel button to run the program.

Thanks to the Half Load function, you can use the upper and lower baskets of your machine at the same time, saving water and energy.

### SteamGloss Function (E)

(Depending on the model)

It provides superior drying performance.

This function can be selected to extend the program duration.

## 7.5 Starting of the programme

Close the door of your dishwasher to start your dishwasher after selecting the programme and additional functions.



Dishwasher softens the water as per the hardness of the mains water. The washing cycle period may also change while the program is being executed as a result of the room temperature, mains water temperature and the amount of dishes.



Care to avoid opening of the door while the dishwasher is being operated. Be careful as steam may come out when you open the door of the dishwasher.



After rinsing, the dishwasher will be quiet for a while in pause mode then will proceed to the drying step to drain all the water left on the dishes and inside the dishwasher and to clean the water softener.

## 7.6 Cancelling the Cycle

Press the Start / Hold / Cancel the Program button for 3 seconds while the door is closed. After the 3 - 2 - 1 countdown, the display will show 0:01, wait until the draining process is completed. Discarding pro-

cess will be completed within 2 minutes and your dishwasher will beep when it is done.



Some models are not equipped with a buzzer.



Detergent or rinse aid may remain inside the dishwasher and/or the dishes being washed as per the step of the program you have cancelled.

## 7.7 End of programme



Your dishwasher turns off automatically after a certain period to save energy when the cycle is ended or not started.



After washing your dishes, keep them inside the dishwasher for approximately 15 minutes to cool. Your dishes will dry faster if you leave the door of your dishwasher ajar during this time. This shall improve the drying efficiency of the dishwasher.

## 7.8 Low Salt Warning indicator

Check the low salt indicator on the screen of your dishwasher to see if you have softening salt in your dishwasher. Add salt to the salt reservoir when the low salt indicator on the display comes on.



The Water Softening System section describes how to set the water hardness level.

## 7.9 Low Rinse Aid Warning indicator

Check the low rinse aid indicator on the screen of your dishwasher to see if you have enough rinse aid in your dishwasher. Add rinse aid to the rinse aid reservoir when the low salt indicator on the display comes on.

## Setting the Rinse Aid Amount

1. After switching on your dishwasher with the On/Off button, enter the Settings menu by pressing the Settings button for 3 seconds depending on the model or by pressing the On/Off and P2 Program buttons simultaneously for 3 seconds.
2. Move to "P" position on the screen by pressing the P2 key.
3. Set to a proper level by selecting one of the "P:0", "P:1", "P:2", "P:3" or "P:4" positions with the P3 program key.

4. To save, exit the settings menu by pressing on/off button of your dishwasher for 3 seconds. Your settings will be saved automatically.

Applies no rinse aid in the P:0 position during the washing cycle.

Applies 1 dose of rinse aid in the P:1 position.

Applies 2 dose of rinse aid in the P:2 position.

Applies 3 dose of rinse aid in the P:3 position.

Applies 4 dose of rinse aid in the P:4 position.

## 8 Maintenance and Cleaning

### 8.1 Maintenance and cleaning



Read "Safety Instructions" section first!



Before cleaning the machine, unplug it and turn off the tap.



Do not use abrasive materials when cleaning.



For the machine to work efficiently, clean the filters and impellers at least once a week.

If cleaned at regular intervals, the life of the product will be extended and frequently encountered problems will be reduced.

#### Cleaning the exterior of the machine

Gently wipe the exterior of your machine and the door seals with a delicate cleaning agent and a damp cloth. Wipe the "control panel" only with a slightly damp cloth.

#### Cleaning the inside of the machine

Clean the machine monthly by running it at the highest possible temperature with detergent or special machine cleaning agents. This will help to remove residues and limescale from the inside of the machine.

If there is water left in the machine, drain the water in the machine by following the procedures in the "Cancelling the program"

section. If the water cannot be drained, remove the filters as indicated in the "Cleaning the filters" section and check if there are any dirt particles that have accumulated at the bottom of the machine and blocked the water path, and clean them if necessary.

### 8.2 Cleaning the filters

(Depending on Model)

For the machine to work efficiently, clean the filters at least once a week. Check if there is any food residue on the filters. If there is food residue, remove the filters and clean them thoroughly under the tap.

1. Remove the micro filter and coarse filter group by turning it counterclockwise and pulling it out.

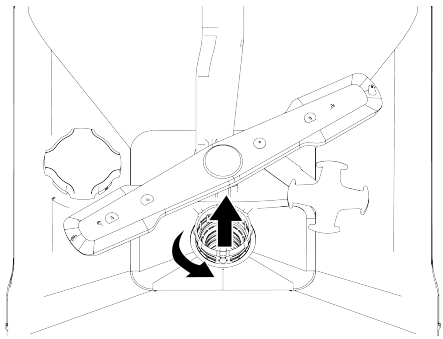

2. Pull the metal/plastic filter (3) out of its place.

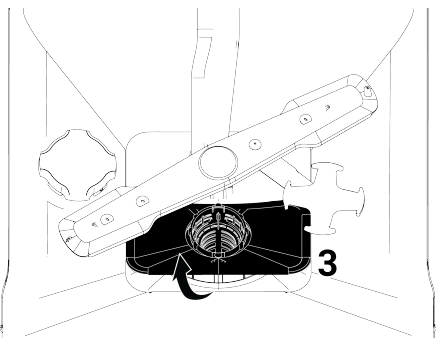

3. Press the two tabs on the coarse filter inwards to separate the coarse filter from the assembly.

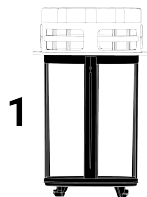

4. Clean all three filters under the tap with a brush.
5. Replace the metal/plastic filter.
6. Place the coarse filter into the micro filter. Make sure it is properly seated. Turn clockwise until you hear a click.

 The machine should not be used without a filter.

 Failure to install the filters correctly will reduce washing effectiveness.

### 8.3 Cleaning the hose filter

The filter on the water inlet hose prevents dirt (sand, clay, rust, etc.) that may come from the city network or your water system from damaging the machine. Check the filter and hose from time to time and clean them if necessary.

1. Turn off the tap and remove the hose.
2. After removing the filter from the hose, clean it under the tap.

3. Place the cleaned filter back into its place inside the hose.
4. Attach the hose to the faucet. (Model dependent)

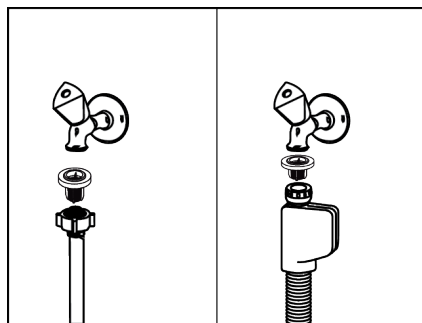

### 8.4 Cleaning the propellers

Clean the impellers at least once a week to ensure efficient operation of the machine.

#### Lower impeller

Check if the lower impeller (1) holes are clogged. If there is a blockage, remove the impeller and clean it. You can remove the lower impeller by pulling it upwards (depending on the model)

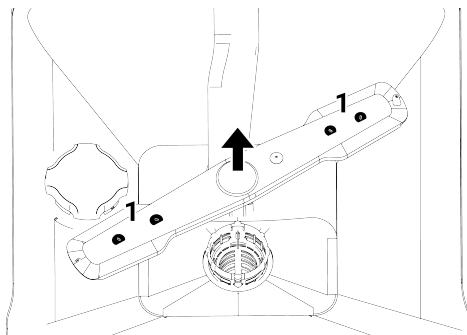

Check if the holes of the impeller assembly are clogged. If there is a blockage, remove the impeller assembly and clean it. (Depending on the model)

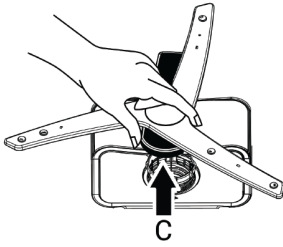

To remove and clean the lower propeller group, hold it with one hand from the points (C) shown in the figure and pull it upwards. After cleaning, reattach the propeller group by following the same steps in reverse. (Depending on the model)

To remove and clean the lower propeller group, hold it with one hand from the points (C) shown in the figure and pull it upwards. After cleaning, reattach the propeller group by following the same steps in reverse. (Depending on the model)

### Upper propeller

Check if the upper impeller (1) holes are clogged. If there is a blockage, remove the impeller and clean it. You can remove the upper impeller by turning its nut to the left. When reattaching the upper propeller, be sure to tighten the nut fully.

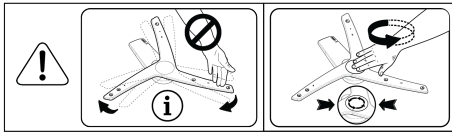

**i** Do not attempt to turn the propeller by holding the ends. Trying to turn it by the ends may cause the gear system inside the propeller to break.

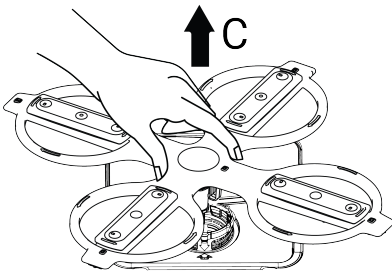
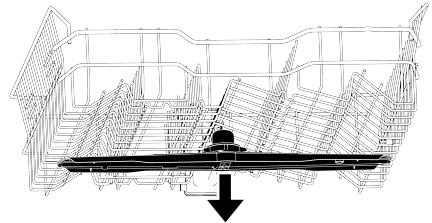
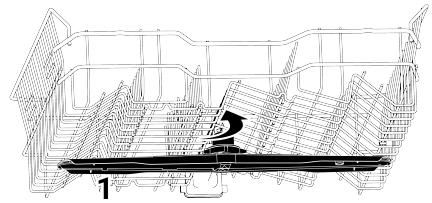

## 9 Troubleshooting

### 9.1 Error Codes, Causes and Solutions

Error Code	Cause	Solution
E01 Warning P1 Blinks Power led flashes	Chassis water filling fault	1-Error algorithm is activated. 2-Cycle ends. If you see the error continuously, 1-Cut off the electricity. 2-Close the valve. 3-Get in touch with the authorized service.
E02 Warning P2 Blinks The Water outage icon illuminates. The Washing led illuminates.	Water outage error	Check the water supply.
	Filter is blocked	1-Cut off the electricity connection. 2-Cut off the water connection. 3-Remove water inlet hose. 4-Check and clean the filter. 5-Establish the water connection. 6-Establish the electricity connection.
	Other	If the error continues, 1-Close your dishwasher. 2-Get in touch with the authorized service.
E06 Warning P2 flashes P6 flashes	Temperature sensor in the dishwasher is faulty	If you see this error continuously and washing performance has reduced, 1-Close your dishwasher. 2-Get in touch with the authorized service.
E07 Warning P2 flashes F1 and F2 flashes	Flowmeter is faulty	1-Error algorithm is activated. 2-Cycle ends. If you see the error continuously, 1-Cut off the electricity. 2-Close the valve. 3-Get in touch with the authorized service.



The error codes can change depend the model.

### 9.2 Troubleshooting

#### The machine is not working.

- The power plug may not be plugged in.  
>>> Check if the power plug is plugged in.
- The fuse may have blown. >>> Check the fuses in your home.
- Water may not be coming out. >>> Make sure the water inlet tap is open.
- The machine's door may be open. >>> Make sure you close the machine's door.
- The "On / Off button" may not have been pressed. >>> Make sure you turned on the machine by pressing the "On / Off button".

### **Dishes are not washed cleanly**

- The dishes are placed irregularly. >>> Place the dishes as specified in the user manual.
- The appropriate program has not been selected. >>> Select a program that washes at a higher temperature and for a longer time.
- The dishes are very dirty >>> Remove the coarse dirt from your dishes with a napkin and place them in your machine.
- The propellers are stuck. >>> Before starting the program, turn the upper and lower propellers by hand to make sure they are turning freely.
- The impeller holes are clogged. >>> The upper or lower impeller holes may be clogged with food debris such as lemon seeds. Clean the impellers regularly as shown in the "Cleaning and Maintenance" section.
- The filters are clogged. >>> Check that the filter system is clean. Clean the filter system regularly as shown in the "Cleaning and Maintenance" section.
- Filters are not installed correctly. >>> Check the filter system and make sure it is installed correctly.
- Baskets are overloaded. >>> Do not load baskets beyond their capacity.
- The detergent has been stored under inappropriate conditions. >>> If you are using powder detergent, do not store the detergent packaging in damp areas. If possible, store it in a lidded storage container. We recommend using tablet detergent for ease of storage.
- Not enough detergent has been added. >>> If you are using powder detergent, add the appropriate amount of detergent according to the soiling level of your dishes and the program descriptions. For best results, we recommend using tablet detergent.
- Rinse aid is insufficient. >>> Check the rinse aid warning indicator and add rinse aid if necessary. If there is sufficient rinse aid in the machine, increase the rinse aid setting.

- The detergent compartment cover is not closed. >>> After filling the detergent compartment, be sure to close the detergent compartment cover.

### **Dishes are not drying**

- The dishes are placed irregularly. >>> Place your dishes in a way that prevents water from accumulating in them during washing.
- Rinse aid is insufficient. >>> Check the rinse aid warning indicator and add rinse aid if necessary. If there is sufficient rinse aid in the machine, increase the rinse aid setting.
- The machine was emptied immediately after the wash cycle was completed. >>> Do not unload your machine immediately after the cycle is complete. Leave the door ajar to allow the steam inside to escape for a while, and then unload the machine once the dishes have cooled to a handleable level. Start unloading from the lower basket. This will prevent any water remaining on any items in the upper basket from dripping onto the items in the lower basket.
- A suitable program has not been selected. >>> Drying performance is also low in short-term programs because the rinsing temperature is low. For higher drying performance, select longer programs.
- Tablet detergent has been used, the tablet button has not been pressed. >>> If your machine has a "tablet detergent" function when using multi-purpose detergent, activate it.
- The surface quality of kitchenware is damaged. >>> Kitchenware with damaged surfaces cannot achieve the expected cleaning performance and is unhygienic to use. Furthermore, water drainage from damaged surfaces is difficult. It is not recommended to wash such kitchenware in the dishwasher.
- It's natural for Teflon kitchenware to experience drying issues. This is due to the structure of Teflon. Because Teflon and

water have different surface tensions, water particles remain on the Teflon surface like beads.

### **Tea, coffee or lipstick stains remain on the dishes.**

- The appropriate program has not been selected. >>> Select a program that washes at a higher temperature and for a longer time.
- The surface quality of kitchenware is damaged. >>> Tea, coffee, and other dye stains that have penetrated into damaged surfaces cannot be washed in dishwashers. Expected cleaning performance cannot be achieved with damaged surfaces, and their use is unhygienic. Washing such kitchenware in a dishwasher is not recommended.
- The detergent has been stored under inappropriate conditions. >>> If you are using powder detergent, do not store the detergent packaging in damp areas. If possible, store it in a lidded storage container. We recommend using tablet detergent for ease of storage.

### **Limescale remains on dishes and glassware takes on a hazy appearance.**

- Rinse aid is insufficient. >>> Check the rinse aid warning indicator and add rinse aid if necessary. If there is sufficient rinse aid in the machine, increase the rinse aid setting.
- The water hardness setting is low or the salt level is insufficient. >>> Check the water hardness setting by measuring the hardness of the mains water accurately.
- There is a salt leak. >>> When filling with salt, be careful not to spill any salt around the filling opening. After filling with salt, ensure the salt container lid is closed. Run the pre-wash program to remove any salt that has spilled inside the machine. Check the lid again at the end of the program, as any remaining salt grains under the lid will dissolve during the pre-wash step, potentially causing the lid to loosen.

### **There is a different smell inside the machine**

- A new washing machine has a distinctive odor that will disappear after a few washes.
- The filters are clogged. >>> Check that the filter system is clean. Clean the filter system regularly as shown in the "Cleaning and Maintenance" section.
- The rinse aid reservoir contains chemicals that may cause odor. >>> Do not use chemicals such as vinegar, hand washing detergent, or descaler.
- Dirty dishes have been left in the dishwasher for 2-3 days. >>> If you're not going to start the dishwasher immediately after loading the dishes, remove any dirt from the dishes and run a pre-wash cycle without detergent every other day. In such cases, do not fully close the dishwasher door to prevent odors from forming inside the machine. You can also use commercially available deodorizers and machine cleaners.

### **Rust stains, tarnishing, surface deterioration on dishes**

- There is a salt leak. >>> Salt can cause deterioration and rust on metal surfaces. Be careful not to spill salt around the filling opening when filling. After filling with salt, ensure the salt container lid is closed. Run the prewash program to remove any spilled salt from the machine. Check the lid again at the end of the program, as any remaining salt grains under the lid will dissolve during the prewash step, potentially causing the lid to loosen.
- Salty food residues have remained on the dishes for a long time. >>> If cutlery contaminated with such foods is to be left in the machine, the dirt should be removed from the surface of the items by pre-washing them, or the dishes should be washed without waiting.
- There is no grounding line in the electrical installation. >>> Check that your machine is connected to a true grounding line. Otherwise, the static electricity generated inside the machine will cause

arc and pitting on the surface of metal objects, removing the protective layer on the surface and causing tarnishing.

- Concentrated cleaning agents like bleach have been used. >>> The protective layer on metal surfaces is damaged by contact with cleaners like bleach and loses its effectiveness over time. Do not wash your dishes with bleach. If you intend to use bleach, your dishwasher must have a dedicated bleach-enabled device and function. This device and function will ensure the appropriate amount of bleach is properly incorporated into the wash cycle, benefiting from its hygienic effect and ensuring optimal rinsing.
- Metal items, especially knives, have been used for purposes other than their intended use. >>> If knives are used for purposes such as canning, the protective coating on their tips will be damaged. Do not use metal kitchen utensils for purposes other than their intended use.
- Cutlery is made of low-quality stainless steel. >>> Rust is inevitable for such items and they should not be washed in dishwashers.
- Previously rusted kitchenware has been washed in the dishwasher. >>> During washing, rust from a rusty item can migrate to other stainless steel surfaces, causing rust to form on those surfaces as well. Such items should not be washed in dishwashers.

#### **There is detergent residue in the detergent dispenser.**

- The detergent was added a long time before the wash cycle. >>> Be sure to add the detergent just before starting the wash cycle.
- The detergent compartment cover is prevented from opening during washing. >>> Place the dishes in a way that does not prevent the detergent compartment cover from opening and water from flowing into the compartment from the impellers.

- The detergent has been stored under inappropriate conditions. >>> If you are using powder detergent, do not store the detergent packaging in damp areas. If possible, store it in a lidded storage container. We recommend using tablet detergent for ease of storage.
- The impeller holes are clogged. >>> The upper or lower impeller holes may be clogged with food debris such as lemon seeds. Clean the impellers regularly as shown in the "Cleaning and Maintenance" section.

#### **The patterns and decorations on kitchenware are fading.**

- Patterned glasses and overglaze porcelain are not dishwasher-safe. Glass and porcelain tableware manufacturers do not recommend washing these types of items in the dishwasher.

#### **The dishes are getting scratched.**

- Kitchen utensils and accessories made of or containing aluminum should not be washed in the dishwasher.
- There is a salt leak. >>> When filling with salt, be careful not to spill any salt around the filling opening. Spilled salt can cause scratches. After filling with salt, ensure the salt container lid is closed. Run the prewash program to remove any salt that has spilled inside the machine. Check the lid again at the end of the program, as any remaining salt particles under the lid will dissolve during the prewash step, potentially causing the lid to loosen.
- The water hardness setting is low or the salt level is insufficient. >>> Check the water hardness setting by measuring the hardness of the mains water accurately.
- Improperly arranging dishes. >>> When placing glasses and other glassware in baskets, place them against the basket's edge, shelves, or glass support wire, not against other dishes. The impact of water during washing can cause two glasses or other dishes to hit each other, potentially causing scratches or breakage on the surfaces.

- Glassware leaves a hazy, milk-stained stain that won't come out even when wiped. When held up to light, it reveals a bluish/rainbow-colored appearance.
- Excessive rinse aid has been used. >>> Reduce the rinse aid setting. Be sure to clean up any rinse aid that spills while filling the rinse aid dispenser.
- Corrosion has occurred on the glass due to soft water. >>> Check the water hardness setting by accurately measuring the hardness of your tap water. If your tap water is soft (<5 dH), do not use salt. Use programs that wash at higher temperatures (such as 60-65 degrees). You can also use commercially available detergents with glass protection.

#### **Foam is formed in the machine.**

- Before placing the dishes in the dishwasher, they were hand-washed with dishwashing detergent and then placed in the machine without rinsing. >>> Hand-washing dishwashing detergents do not have a foam control. There is no need to hand-wash the dishes with detergent before placing them in the machine. Simply rinse the dishes with water or scrape off any coarse dirt with a paper towel or fork.
- Rinse aid was spilled inside the machine while filling it. >>> Be careful not to spill rinse aid inside the machine while filling it. Clean up any spilled rinse aid using a paper towel.

- The lid of the rinse aid compartment was left open. >>> Make sure to close the lid of the rinse aid compartment after filling the rinse aid.
- The detergent may have expired or may not have been stored under appropriate storage conditions. >>> Check the information on the detergent packaging.

#### **Foam is leaking out of the dishwasher**

- The machine may not be balanced or the feet may not be adjusted properly. >>> Make sure the machine is balanced.
- It may be caused by the detergent used. >>> Change the detergent.

#### **Kitchenware breaks.**

- The dishes are placed irregularly. >>> Place the dishes as specified in the user manual.
- Baskets are overloaded. >>> Do not load baskets beyond their capacity.
- Water remains in the dishwasher after the program has finished.
- The filters are clogged. >>> Check that the filter system is clean. Clean the filter system regularly as shown in the "Cleaning and Maintenance" section.
- The drain hose is clogged/blocked. >>> Check the drain hose. If necessary, remove and clear the blockage, then reattach as specified in the installation instructions.

## **10 DISCLAIMER / WARNING**

Some (simple) faults can be repaired by end users without causing any safety problems or unsafe use, provided that they are carried out in accordance with the following instructions. (See the section "I Want to Repair Myself").

Therefore, except for the parts specified in the "I Want to Repair Myself" section that can be repaired by end users, repair by an authorised service station is strongly recommended to prevent safety problems and is mandatory for the continuation of the Beko product warranty.

### **I WANT TO REPAIR MYSELF**

Repairs to be carried out by end users can be performed for the following spare parts: External Power Supplies, Remote Control. (Current spare parts list is available at <https://www.beko.com.tr/destek> address as of 1 March 2021)

In addition, to ensure product safety and to avoid the risk of serious injury, repairs must be carried out according to the instructions in the instruction manual or at <https://www.beko.com.tr/destek> address. For your safety, unplug the product before carrying out any repair work.

Cannot be held responsible for any safety problems that may arise due to repair operations <https://www.beko.com.tr/destek> or attempts by end-users to repair parts other than those specified in the user manuals or in accordance with the instructions in the <https://www.beko.com.tr/destek> address and parts in the current parts list available at the Beko address. In such a case, the Beko product warranty will be invalid.

Therefore, end-users are strongly recommended to refrain from performing repair operations for parts other than the spare parts mentioned above by themselves and to contact an authorised service station if necessary. Such repair attempts by end users may cause safety issues; damage the product and subsequently result in fire, flooding, electric shock and serious personal injury.

Repair processes of the following parts, but not limited to those listed, should be performed by authorised service stations: Internal Power Supply, Capacitors, Battery and Accumulators, etc.

The manufacturer/seller cannot be held responsible for any failure of end users to comply with the above.



