

Quick Guide

Operating the product

! Read "Safety Instructions" section first!

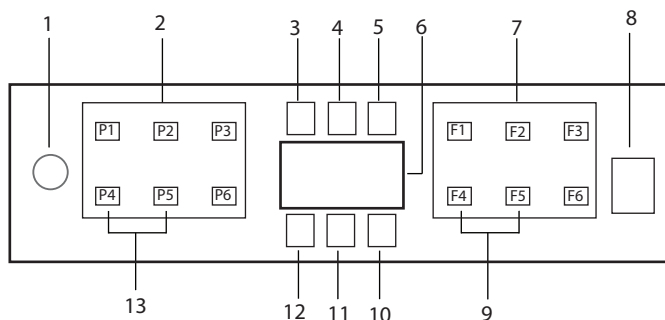

1. On / Off Button
2. Program Selection Button
3. Low Salt Warning Indicator
4. Low Rinse Aid Warning Indicator
5. Program Running Indicator
6. Display
7. Function Selection Button
 - F1 Hygiene Intense function
 - F2 SteamGloss Function
 - F3 TrayWash Function
 - F4 TimeDelay function
 - F5 Fast+ Function
 - F6 Half Load function
8. Start/Pause/Cancel Button
9. SelfDry Function
10. SelfDry Indicator
11. (Not in use)
12. Child (Key) Lock Indicator
13. Child (Key) Lock Function

i Do not touch the machine display with wet hands.

i The buttons cannot be operated when the door is open. Make sure the door is closed for the buttons to operate.

Programme Data and Average Consumption Values Table

Programme number	1	2	3	4	5	6
Programme name	Auto	Intensive	Eco *	Delicate	Quick&Shine (#)	Mini (#)
Cleaning temperature	40-65 °C Determines the soiling degree of the dishes and sets the temperature and amount of the washing water as well as the washing time automatically. Suitable for all types of dishes.	70 °C Suitable for heavily soiled dishes, pots and pans.	50 °C Suitable for washing dishes with normal amount of soil. It is the most efficient program in terms of combined power and water consumption. This is used for assessing the compliance with EU's eco-design directive.	40 °C Special programme for gentle cleaning of delicate glassware.	60 °C Daily washing programme for normally soiled dishes in the fastest way.	35 °C Suitable for lightly soiled daily dishes that are scraped or pre-cleaned.
Degree of Soiling	Medium to high	High	Medium	Low	Medium	Low
Prewash	+	+	+	+	-	-
Wash	+	+	+	+	+	+
Dry	+	+	+	+	+	-
Duration (min)	110-198	187	224	120	58	30
Water (l)	9,4-12,4	16,8	9,5	14,4	10,6	10,8
Energy (kWh)	0,90-1,45	1,51	0,747	0,92	1,18	0,8

Loading Capacity: 14







The consumption values shown in the table were determined under standard conditions. Differences may therefore occur under practical conditions. * Reference programme for testing institutes. The tests in accordance with EN 50242/60436 must be carried out with a full water softener salt dispenser and a full rinse aid reservoir, and using the test programme. The values given for programmes other than Eco 50°C programme are indicative only. (#) Additional functions might cause changes in programme durations.

Quick Guide

Adjusting the water softening system

Washing, rinsing and drying performance of your dishwasher will improve when the water softening system is adjusted correctly.







To adjust the system, first learn the water hardness in your region and adjust as indicated below.

- Unpack the test strip.
 - Open the tap and let the water flow for approx. 1 minute.
 - Dip in the test strip into the water for 1 second.
 - Take out the strip from the water and shake it.
 - Wait for 1 minute.
 - Make the necessary adjustment according to the test strip.
- | | |
|---------|--|
| Level 0 |  |
| Level 1 |  |
| Level 2 |  |
| Level 3 |  |
| Level 4 |  |
| Level 5 |  |

After the determination of the water hardness:

1. When the door is closed, after turning on your machine with the On/Off button, enter the Sub-Menu by pressing the On-Off and P2 program buttons simultaneously for 3 seconds.
2. Move to "r" position on the display by pressing the P2 button.
3. Set it to the appropriate level by selecting one of the "r: 1", "r: 2", "r: 3", "r: 4" or "r: 5" positions with the P3 program button.
4. Exit the settings menu by pressing the On/Off button for 3 seconds. Your settings will be saved automatically.

Water hardness level adjustment table

Hardness Level	English Water Hardness °dE	German Water Hardness °dH	French* Water Hardness °dF	Water Hardness Level Indicator
Level 0 	0-5	0-4	0-8	Press the Selection key to switch the water hardness level to position 1. (r1)
Level 1 	6-9	5-7	9-13	
Level 2 	10-15	8-12	14-22	Press the Selection key to switch the water hardness level to position 2. (r2)
Level 3 	16-19	13-15	23-27	Press the Selection key to switch the water hardness level to position 3. (r3)
Level 4 	20-24	16-19	28-34	Press the Selection key to switch the water hardness level to position 4. (r4)
Level 5 	25-62	20-50	35-90	Press the Selection key to switch the water hardness level to position 5. (r5)

- If the hardness level of the water that you use is above 50°dH or if you are using well water, than it is recommended to use filter and water purification devices.
 - If the hardness level of the water that you use is below 7°dH, there is no need to use salt in your dishwasher. In this case, the Salt Indicator light on the control panel of your dishwasher will light continuously.
 - If the water hardness is set to level 1, the Salt Indicator will light continuously although it is not necessary to use salt. If you use salt under this condition, salt will not be consumed and the lamp will not illuminate.
- i** When moving, you will need to set the water hardness level of your dishwasher again according to the information above, depending on the water hardness of the place you have moved to. If the water hardness level of your machine is adjusted previously, your machine will display the most recent hardness level adjustment.