

DBM 208120 B

USER MANUAL

BUILT-IN OVEN
MADE IN TURKEY

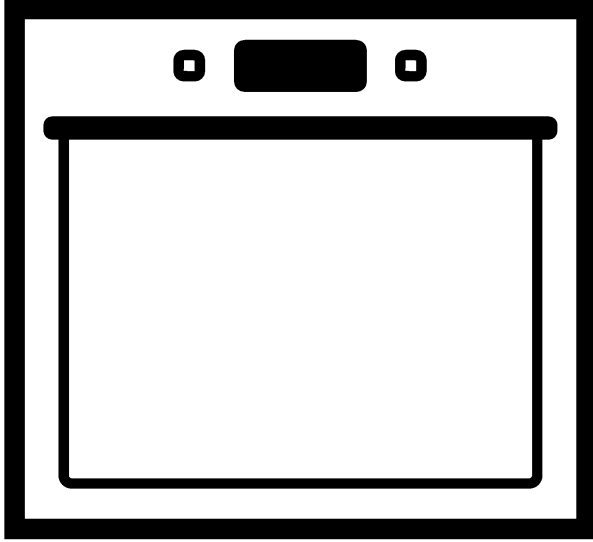

Before operating this unit, please read this manual thoroughly, and retain for future reference.

Please read this user manual first!

Dear Customer,

Thank you for purchasing this Dawlance product. We hope that you get the best results from your product which has been manufactured with high quality and state-of-the-art technology. Therefore, please read this entire user manual and all other accompanying documents carefully before using the product and keep it as a reference for future use. If you handover the product to someone else, give the user manual as well. Follow all warnings and information in the user manual.

Remember that this user manual is also applicable for several other models.

Differences between models will be identified in the manual.

Explanation of symbols

Throughout this user manual the following symbols are used:



Important information or useful hints about usage.



Warning of hazardous situations with regard to life and property.



Warning of electric shock.



Warning of risk of fire.



Warning of hot surfaces.



Arçelik A.Ş.
Karaağaç caddesi No:2-6
34445 Sütlüce/İstanbul/TURKEY
Made in TURKEY

TABLE OF CONTENTS

1 Important instructions and warnings for safety and environment 4

General safety	4
Electrical safety.....	5
Product safety	6
Intended use	8
Safety for children.....	8
Disposing of the old product	9
Package information	9

2 General information 10

Overview	10
Package contents.....	11
Technical specifications	12

3 Installation 13

Before installation	13
Installation and connection	15
Future Transportation.....	17

4 Preparation 18

Tips for saving energy	18
Initial use	18
Time setting.....	18
First cleaning of the appliance	19
Initial heating	19

5 How to operate the oven 20

General information on baking, roasting and grilling	20
How to operate the electric oven	21
Operating modes.....	21
Using the oven clock.....	22
Cooking times table	25
How to operate the grill	29
Cooking times table for grilling	29

6 Maintenance and care 30

General information.....	30
Cleaning the control panel.....	30
Cleaning the oven	30
Removing the oven door	31
Removing the door inner glass	32
Replacing the oven lamp	33

7 Troubleshooting 34

1 Important instructions and warnings for safety and environment

This section contains safety instructions that will help protect from risk of personal injury or property damage. Failure to follow these instructions shall void any warranty.

General safety

- This appliance can be used by children aged from 8 years and above and persons with reduced physical, sensory or mental capabilities or lack of experience and knowledge if they have been given supervision or instruction concerning use of the appliance in a safe way and understand the hazards involved.
Children shall not play with the appliance. Cleaning and user maintenance shall not be made by children without supervision.
- The appliance is not to be used by persons (including children) with reduced physical, sensory or mental capabilities, or lack of experience and knowledge, unless they have been given supervision or instruction. Children should be supervised and ensure they do not play with the appliance
- If the product is handed over to someone else for personal use or second-hand use purposes, the user manual, product labels and other relevant documents and parts should be also given.
- Installation and repair procedures must always be performed by Authorised Service Agents. The manufacturer shall not be held responsible for damages arising from procedures carried out by unauthorised persons which may also void the warranty. Before installation, read the instructions carefully.
- Do not operate the product if it is defective or has any visible damage.
- Ensure that the product function knobs are switched off after every use.

Electrical safety

- If the product has a failure, it should not be operated unless it is repaired by an Authorised Service Agent. There is the risk of electric shock!
- Only connect the product to a grounded outlet/line with the voltage and protection as specified in the “Technical specifications”. Have the grounding installation made by a qualified electrician while using the product with or without a transformer. Our company shall not be liable for any problems arising due to the product not being earthed in accordance with the local regulations.
- Never wash the product by spreading or pouring water onto it! There is the risk of electric shock!
- Never touch the plug with wet hands! Never unplug by pulling on the cable, always pull out by holding the plug.
- The product must be disconnected during installation, maintenance, cleaning and repairing procedures.
- If the power connection cable for the product is damaged, it must be replaced by the manufacturer, its service agent or similarly qualified persons in order to avoid a hazard.
- The appliance must be installed so that it can be completely disconnected from the mains supply. The separation must be provided by a switch built into the fixed electrical installation, according to construction regulations.
- Rear surface of the oven gets hot when it is in use. Make sure that the electrical connection does not contact with the rear surface; otherwise, connections can get damaged.
- Do not trap the mains cable between the oven door and frame and do not route it over hot surfaces. Otherwise, cable insulation may melt and cause fire as a result of short circuit.
- Any work on electrical equipment and systems should only be carried out by authorised and qualified persons.

- In case of any damage, switch off the product and disconnect it from the mains. To do this, turn off the fuse at home.
- Make sure that fuse rating is compatible with the product.

Product safety

- **WARNING:** The appliance and its accessible parts become hot during use. Care should be taken to avoid touching heating elements. Children less than 8 years of age shall be kept away unless continuously supervised.
- Never use the product when your judgment or coordination is impaired by the use of alcohol and/or drugs.
- Be careful when using alcoholic drinks in your dishes. Alcohol evaporates at high temperatures and may cause fire since it can ignite when it comes into contact with hot surfaces.
- Food Poisoning Hazard: Do not let food sit in oven for more than 1 hour before or after cooking. Doing so can result in food poisoning or sickness.
- Do not place any flammable materials close to the product as the sides may become hot during use.
- During use the appliances becomes hot. Care should be taken to avoid touching heating elements inside the oven.
- Keep all ventilation slots clear of obstructions.
- Do not heat closed tins and glass jars in the oven. The pressure that would build-up in the tin/jar may cause it to burst.
- Do not place baking trays, dishes or aluminium foil directly onto the bottom of the oven. The heat accumulation might damage the bottom of the oven.
- Do not use harsh abrasive cleaners or sharp metal scrapers to clean the oven door glass since they can scratch the surface, which may result in shattering of the glass.
- Do not use steam cleaners to clean the appliance as this may cause an electric shock.

- (Varies depending on the product model.)

Placing the wire shelf and tray onto the wire racks properly

It is important to place the wire shelf and/or tray onto the rack properly. Slide the wire shelf or tray between 2 rails and make sure that it is balanced before placing food on it (Please see the following figure).

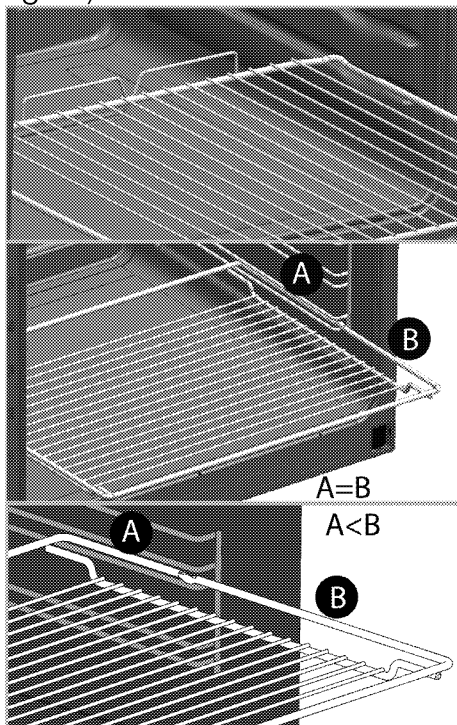

- Do not use the product if the front door glass is removed or cracked.

- Always use heat resistant oven gloves when putting in or removing dishes into/from the hot oven.
- Place the baking paper into the cooking pot or on to the oven accessory (tray, wire grill etc) together with the food and then insert all into the preheated oven. Remove the excess parts of the baking paper overflowing from the accessory or the pot in order to prevent the risk of touching the oven's heating elements. Never use the baking paper in an operating temperature higher than the indicated value for the baking paper. Do not place the baking paper directly on the base of the oven.
- **WARNING:** Ensure that power cord of the appliance is unplugged or circuit breaker is switched off before replacing the lamp to avoid the possibility of electric shock.
- The appliance must not be installed behind a decorative door in order to avoid overheating.

Prevention against possible fire risk!

- Ensure all electrical connections are secure and tight to prevent risk of arcing.
- Do not use damaged cables or extension cables.
- Ensure liquid or moisture is not accessible to the electrical connection point.

Intended use

- This product is designed for domestic use. Commercial use will void the guarantee.
- **CAUTION:** This appliance is for cooking purposes only. It must not be used for other purposes, for example room heating.
- This product should not be used for warming the plates under the grill, drying towels, dish cloths etc. by hanging them on the oven door handles. This product should also not be used for room heating purposes.
- The manufacturer shall not be liable for any damage caused by improper use or handling errors.
- The oven can be used for defrosting, baking, roasting and grilling food.

Safety for children

- **WARNING:** Accessible parts may become hot during use. Young children should be kept away.
- The packaging materials will be dangerous for children. Keep the packaging materials away from children. Please dispose of all parts of the packaging according to environmental standards.
- Electrical products are dangerous to children. Keep children away from the product when it is operating and do not allow them to play with the product.
- Do not place any items above the appliance that children may reach for.
- When the door is open, do not load any heavy object on it and do not allow children to sit on it. It may overturn or door hinges may get damaged.

Disposing of the old product

Compliance with the WEEE Directive and Disposing of the Waste Product:



This product complies with EU WEEE Directive (2012/19/EU). This product bears a classification symbol for waste electrical and electronic equipment (WEEE).

This product has been manufactured with high quality parts and materials which can be reused and are suitable for recycling. Do not dispose of the waste product with normal domestic and other wastes at the end of its service life. Take it to the collection center for the recycling of electrical and electronic

equipment. Please consult your local authorities to learn about these collection centers.

Compliance with RoHS Directive:

The product you have purchased complies with EU RoHS Directive (2011/65/EU). It does not contain harmful and prohibited materials specified in the Directive.

Package information

- Packaging materials of the product are manufactured from recyclable materials in accordance with our National Environment Regulations. Do not dispose of the packaging materials together with the domestic or other wastes. Take them to the packaging material collection points designated by the local authorities.

2 General information

Overview

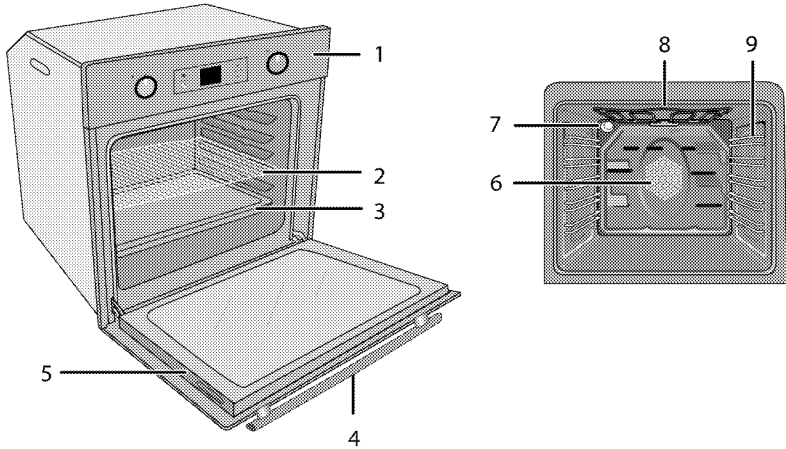

- 1 Control panel
- 2 Wire shelf
- 3 Tray
- 4 Handle
- 5 Door

- 6 Fan motor (behind steel plate)
- 7 Lamp
- 8 Top heating element
- 9 Shelf positions

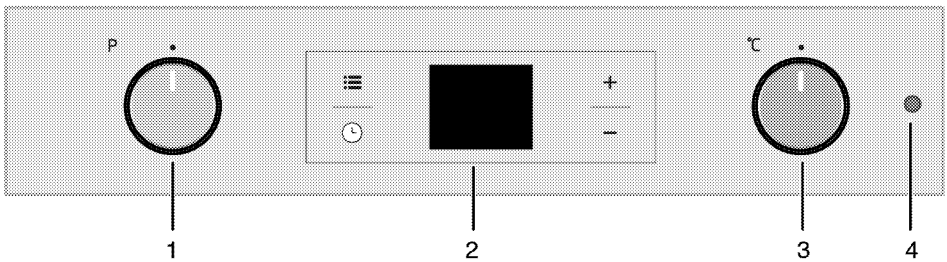

- 1 Function knob
- 2 Digital timer
- 3 Thermostat knob
- 4 Thermostat lamp

Package contents

i Accessories supplied can vary depending on the product model. Not every accessory described in the user manual may exist on your product.

1. User manual

2. Standard tray

Used for pastries, frozen foods and big roasts.

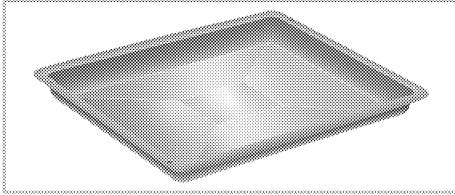

3. Deep tray

Used for pastries, large roasts, juicy dishes, and for collecting the fat while grilling.

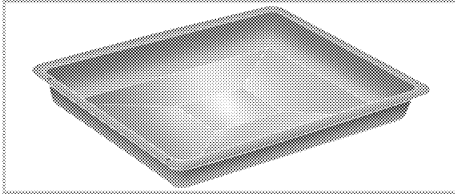

4. Wire grill

Used for roasting and for placing the food to be baked, roasted or cooked in casserole dishes to the desired rack.

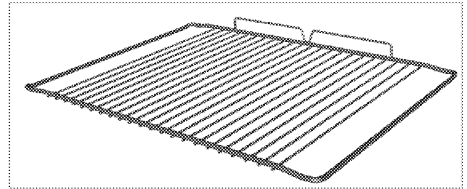
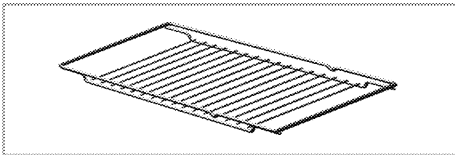

5. Placing the wire shelf and tray onto the telescopic racks properly (This feature is optional. It may not exist on your product.)

Telescopic racks allow you to install and remove the trays and wire shelf easily.

When using the tray and wire shelf with telescopic racks, make sure that the pins at the rear section of the telescopic rack stands against the edges of the wire shelf and tray.

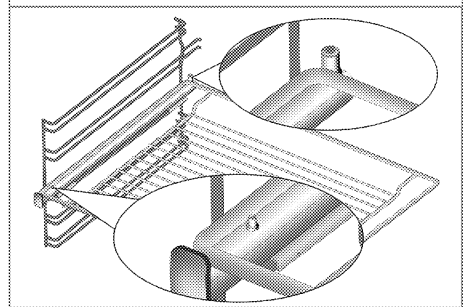
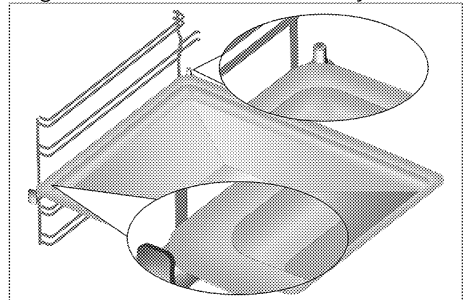

Technical specifications

Voltage / frequency	220-240 V ~ 50 Hz
Total power consumption	2.5 kW
Cable type / section	min.H05VV-FG 3 x 1,5 mm ²
External dimensions (height / width / depth)	595 mm/594 mm/567 mm
Installation dimensions (height / width / depth)	**590 or 600 mm/560 mm/min. 550 mm
Main oven	Multifunction oven
Inner lamp	15/25 W
Grill power consumption	2.2 kW

Basics: Information on the energy label of electrical ovens is given in accordance with the EN 60350-1 / IEC 60350-1 standard. Those values are determined under standard load with bottom-top heater or fan assisted heating (if any) functions.

Energy efficiency class is determined in accordance with the following prioritization depending on whether the relevant functions exist on the product or not. 1-Cooking with eco-fan, 2- Turbo slow cooking, 3- Turbo cooking, 4- Fan assisted bottom/top heating, 5-Top and bottom heating.

** See. *Installation*, page 13.

 Technical specifications may be changed without prior notice to improve the quality of the product.

 Figures in this manual are schematic and may not exactly match your product.

 Values stated on the product labels or in the documentation accompanying it are obtained in laboratory conditions in accordance with relevant standards. Depending on operational and environmental conditions of the product, these values may vary.

3 Installation

Product must be installed by a qualified person in accordance with the regulations in force. The manufacturer shall not be held responsible for damages arising from procedures carried out by unauthorized persons which may also void the warranty.

 Preparation of location and electrical installation for the product is under customer's responsibility.

 The product must be installed in accordance with all local electrical regulations.

 Prior to installation, visually check if the product has any defects on it. If so, do not have it installed. Damaged products cause risks for your safety.

Before installation

The appliances must not be installed behind a decorative door in order to avoid overheating.

The appliance is intended for installation in commercially available kitchen cabinets. A safety distance must be left between the appliance and the kitchen walls and furniture. See figure (values in mm).

- Surfaces, synthetic laminates and adhesives used must be heat resistant (100 °C minimum).
- Kitchen cabinets must be set level and fixed.
- If there is a drawer beneath the oven, a shelf must be installed in order to separate from the oven and drawer.
- Carry the appliance with at least two persons.
- Hold the oven from the slots for handling on both sides to move it.
- Before installing the product, remove all materials and documents inside.
- Kitchen furniture must be in compliance with the dimensions given in the figure below. At the rear section of the kitchen furniture, an opening must be cut out with the dimensions given in the figure below to ensure sufficient ventilation.
-  Do not install the appliance next to refrigerators or freezers. The heat emitted by the appliance will lead to an increased energy consumption of cooling appliances.
-  The door and/or handle must not be used for lifting or moving the appliance.

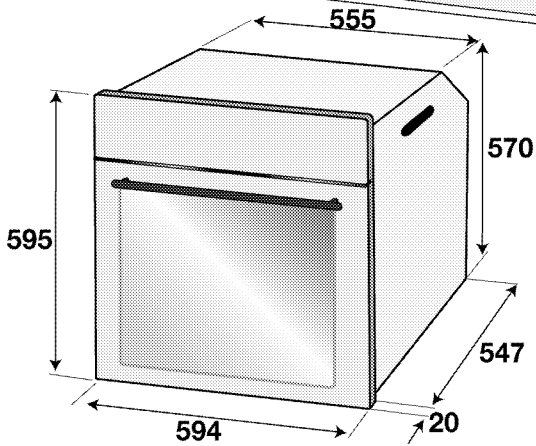
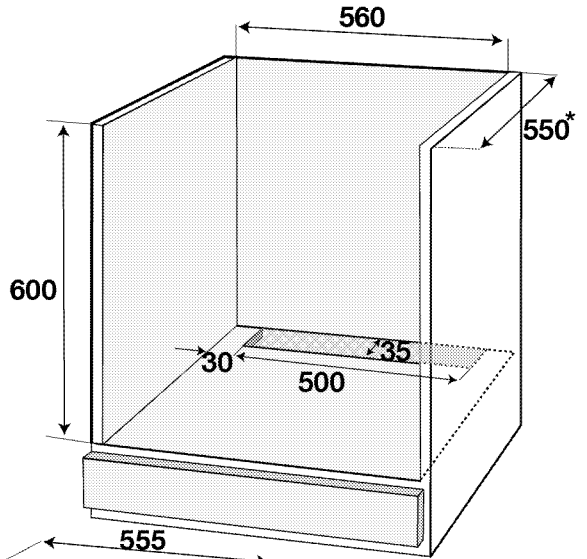
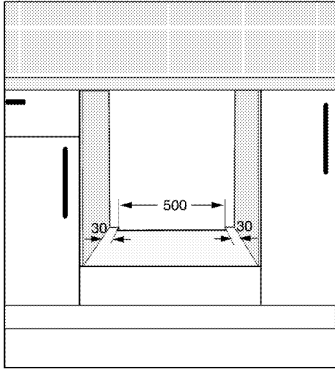
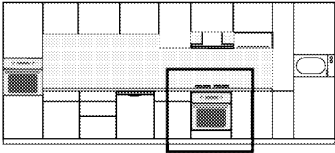

* min.

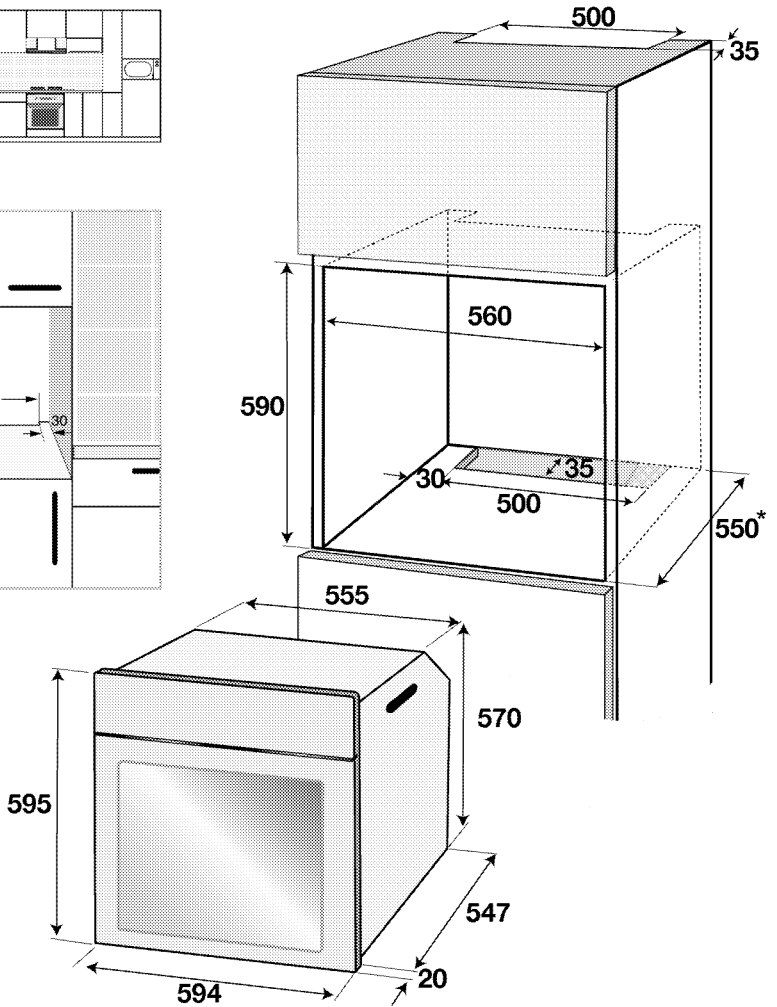
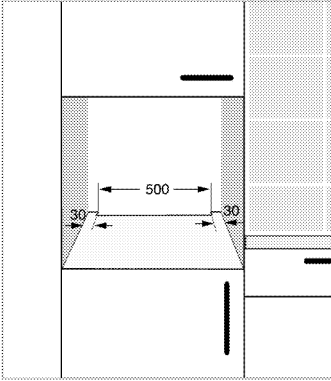
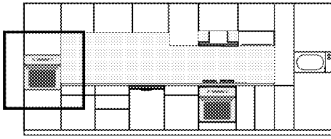

* min.

Installation and connection

- The product must be installed in accordance with all local gas and electrical regulations.

Electrical connection

Connect the product to a grounded outlet/line protected by a miniature circuit breaker of suitable capacity as stated in the "Technical specifications" table. Have the grounding installation

made by a qualified electrician while using the product with or without a transformer. Our company shall not be liable for any damages that will arise due to using the product without a grounding installation in accordance with the local regulations.

! The product must be connected to the mains supply only by an authorised and qualified person. The product's warranty period starts only after correct installation.

Manufacturer shall not be held responsible for damages arising from procedures carried out by unauthorised persons.

! The power cable must not be clamped, bent or trapped or come into contact with hot parts of the product.

A damaged power cable must be replaced by a qualified electrician. Otherwise, there is risk of electric shock, short circuit or fire!

- Connection must comply with national regulations.
- The mains supply data must correspond to the data specified on the type label of the product. Open the front door to see the type label.
- Power cable of your product must comply with the values in "Technical specifications" table.

! Before starting any work on the electrical installation, disconnect the product from the mains supply. There is the risk of electric shock!

i Power cable plug must be within easy reach after installation (do not route it above the hob).

i While performing the wiring, you must apply with the national/local electrical regulations and must use the appropriate socket outlet/line and plug for oven. In case of the product's power limits are out of current carrying capability of plug and socket outlet/line, the product must be connected through fixed electrical installation directly without using plug and socket outlet/line.

Plug the power cable into the socket.

Installing the product

1. Slide the oven into the cabinet, align and secure it while making sure that the power cable is not broken and/or trapped.

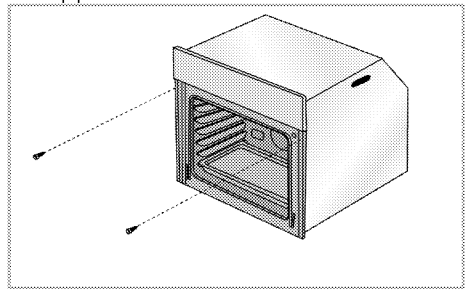

Secure the oven with 2 screws as illustrated.

After the installation, make sure that the screws are sufficiently tightened and the oven does not move. Oven may tip over during use if it is not installed as per the instructions and if the screws are not sufficiently tightened.

For products with cooling fan (This may not exist on your product.)

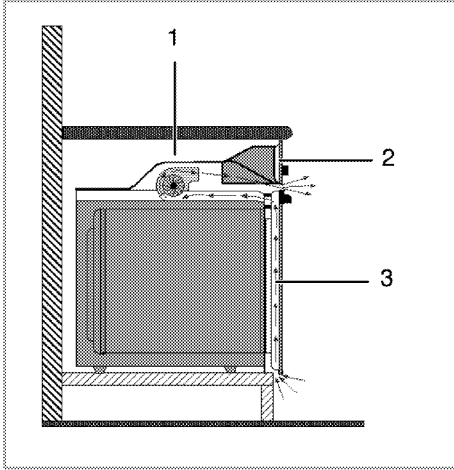

- 1 Cooling fan
- 2 Control panel
- 3 Door

The built-in cooling fan cools both the built-in cabinet and the front of the product.

i Cooling fan continues to operate for about 20-30 minutes after the oven is switched off.

If you have cooked by programming the timer of the oven, cooling fan will also be switched off at the end of the cooking time together with all functions.

Final check

1. Operate the product.
2. Check the functions.

Future Transportation

- Keep the product's original carton and transport the product in it. Follow the instructions on the carton. If you do not have the original carton, pack the product in bubble wrap or thick cardboard and tape it securely.
- To prevent the wire grill and tray inside the oven from damaging the oven door, place a strip of cardboard onto the inside of the oven door that lines up with the position of the trays. Tape the oven door to the side walls.
- Do not use the door or handle to lift or move the product.

i Do not place any objects onto the product and move it in upright position.

i Check the general appearance of your product for any damages that might have occurred during transportation.

4 Preparation

Tips for saving energy

The following information will help you to use your appliance in an ecological way, and to save energy:

- Use dark coloured or enamel coated cookware in the oven since the heat transmission will be better.
- While cooking your dishes, perform a preheating operation if it is advised in the user manual or cooking instructions.
- Do not open the door of the oven frequently during cooking.
- Try to cook more than one dish in the oven at the same time whenever possible. You can cook by placing two cooking vessels onto the wire shelf.
- Cook more than one dish one after another. The oven will already be hot.
- You can save energy by switching off your oven a few minutes before the end of the cooking time. Do not open the oven door.
- Defrost frozen dishes before cooking them.

Initial use

Time setting

- i** While making any adjustment, related symbols will flash on the display.

Press **+**/**-** keys to set the time of the day after the oven is energized for the first time.

- i** For touch control models, touch **≡** first and then use **+** / **-** to set the time of the day.

Confirm the setting by touching **⏸** symbol and wait for 4 seconds without touching any keys to confirm.

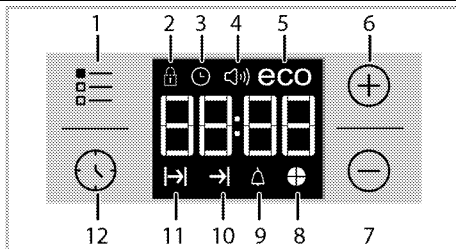

- 1 Adjustment key
- 2 Key lock symbol
- 3 Clock symbol
- 4 Alarm volume symbol (This may not exist on your product.)
- 5 Eco mode symbol
- 6 Plus key
- 7 Minus key
- 8 Time slice symbol
- 9 Alarm symbol
- 10 End of Cooking Time symbol
- 11 Cooking Time symbol
- 12 Program key

- i** If the initial time is not set, clock will run starting from 12:00 and **⏸** symbol will be displayed. The symbol will disappear once the time is set.

- i** Current time settings are canceled in case of power failure. It needs to be readjusted.

First cleaning of the appliance

 The surface might get damaged by some detergents or cleaning materials.

Do not use aggressive detergents, cleaning powders/creams or any sharp objects during cleaning.

Do not use harsh abrasive cleaners or sharp metal scrapers to clean the oven door glass since they can scratch the surface, which may result in shattering of the glass.

1. Remove all packaging materials.
2. Wipe the surfaces of the appliance with a damp cloth or sponge and dry with a cloth.

Initial heating

Heat up the product for about 30 minutes and then switch it off. Thus, any production residues or layers will be burnt off and removed.

 Hot surfaces cause burns!
Product may be hot when it is in use. Never touch the hot burners, inner sections of the oven, heaters and etc. Keep children away. Always use heat resistant oven gloves when putting in or removing dishes into/from the hot oven.

Electric oven

1. Take all baking trays and the wire grill out of the oven.
2. Close the oven door.
3. Select Static position.
4. Select the highest grill power; See *How to operate the electric oven, page 21*.
5. Operate the oven for about 30 minutes.
6. Turn off your oven; See *How to operate the electric oven, page 21*

Grill oven

1. Take all baking trays and the wire grill out of the oven.
2. Close the oven door.
3. Select the highest grill power; see *How to operate the grill, page 29*.
4. Operate the grill about 15 minutes.
5. Turn off your grill; see *How to operate the grill, page 29*

 Smoke and smell may emit for a couple of hours during the initial operation. This is quite normal. Ensure that the room is well ventilated to remove the smoke and smell. Avoid directly inhaling the smoke and the smell that emits.

5 How to operate the oven

General information on baking, roasting and grilling



Hot surfaces cause burns! Product may be hot when it is in use. Never touch the hot burners, inner sections of the oven, heaters and etc. Keep children away. Always use heat resistant oven gloves when putting in or removing dishes into/from the hot oven.



Be careful when opening the oven door as steam may escape. Exiting steam can scald your hands, face and/or eyes.

Tips for baking

- Use non-sticky coated appropriate metal plates or aluminum vessels or heat-resistant silicone moulds.
- Make best use of the space on the rack.
- Place the baking mould in the middle of the shelf.
- Select the correct rack position before turning the oven or grill on. Do not change the rack position when the oven is hot.
- Keep the oven door closed.

Tips for roasting

- Treating whole chicken, turkey and large piece of meat with dressings such as lemon juice and black pepper before cooking will increase the cooking performance.
- It takes about 15 to 30 minutes longer to roast meat with bones when compared to roasting the same size of meat without bones.

- Each centimeter of meat thickness requires approximately 4 to 5 minutes of cooking time.
- Let meat rest in the oven for about 10 minutes after the cooking time is over. The juice is better distributed all over the roast and does not run out when the meat is cut.
- Fish should be placed on the middle or lower rack in a heat-resistant plate.

Tips for grilling

When meat, fish and poultry are grilled, they quickly get brown, have a nice crust and do not get dry. Flat pieces, meat skewers and sausages are particularly suited for grilling as are vegetables with high water content such as tomatoes and onions.

- Distribute the pieces to be grilled on the wire shelf or in the baking tray with wire shelf in such a way that the space covered does not exceed the size of the heater.
- Slide the wire shelf or baking tray with grill into the desired level in the oven. If you are grilling on the wire shelf, slide the baking tray to the lower rack to collect fats. The baking tray to be slid must be of a size that covers the whole grilling area. This tray might not be provided with the product. Add some water in the baking tray for easy cleaning.



Foods that are not suitable for grilling carry the risk of fire. Only grill food which is suitable for intensive grilling heat. Do not place the food too far in the back of the grill. This is the hottest area and fatty food may catch fire.

How to operate the electric oven

Your oven is equipped with pop-out knobs that protrude when you press them.

1. Press inwards to protrude the knob and then turn it to make the desired setting.

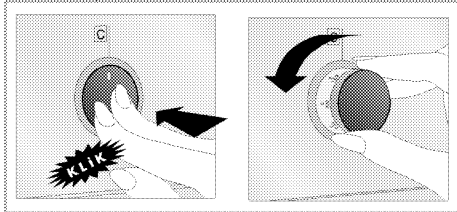

2. When the cooking process is finished, press the knob inwards.

Select temperature and operating mode

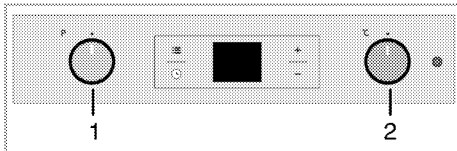

- 1 Function knob
- 2 Thermostat knob

1. Set the Function knob to the desired operating mode.
2. Set the Temperature knob to the desired temperature.

» Oven heats up to the adjusted temperature and maintains it. During heating, temperature lamp stays on.

Switching off the electric oven

Turn the function knob and temperature knob to off (upper) position.

Rack positions (For models with wire shelf)

It is important to place the wire shelf onto the side rack correctly. Wire shelf must be inserted between the side racks as illustrated in the figure.

Do not let the wire shelf stand against the rear wall of the oven. Slide your wire

shelf to the front section of the rack and settle it with the help of the door in order to obtain a good grill performance. (Varies depending on the product model.)

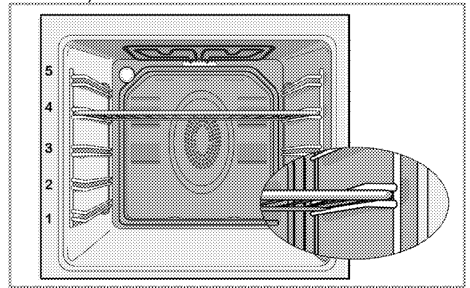

Operating modes

The order of operating modes shown here may be different from the arrangement on your product.

Top and bottom heating



Top and bottom heating are in operation. Food is heated simultaneously from the top and bottom. For example, it is suitable for cakes, pastries, or cakes and casseroles in baking moulds. Cook with one tray only.

Bottom heating



Only bottom heating is in operation. It is suitable for pizza and for subsequent browning of food from the bottom.



This function must be used for easy steam cleaning as well.

Fan supported bottom/top heating



Top heating, bottom heating plus fan (in the rear wall) are in operation. Hot air is evenly distributed throughout the oven rapidly by means of the fan. Cook with one tray only.

Operating with fan



The oven is not heated. Only the fan (in the rear wall) is in operation. Suitable for thawing frozen granular food slowly at room temperature and cooling down the cooked food.

Fan Heating



Warm air heated by the rear heater is evenly distributed throughout the oven rapidly by means of the fan.



It is suitable for cooking your meals in different rack levels and preheating is not required in most cases. Suitable for cooking with multi trays.

This function must be used for easy steam cleaning as well.

3D⁺ function



Top heating, bottom heating and fan assisted heating (in the rear wall) are in operation. Food is cooked evenly and quickly all around. Cook with one tray only.

Full grill



Large grill at the ceiling of the oven is in operation. It is suitable for grilling large amount of meat.

- Put big or medium-sized portions in correct rack position under the grill heater for grilling.
- Turn the food after half of the grilling time.

Grill+Fan



Grilling effect is not as strong as in Full Grill

- Put small or medium-sized portions in correct shelf position under the grill heater for grilling.
- Turn the food after half of the grilling time.

Using the oven clock

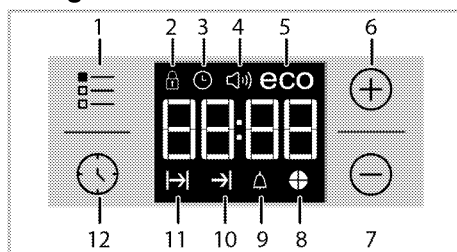

- 1 Adjustment key
- 2 Key lock symbol
- 3 Clock symbol
- 4 Alarm volume symbol (This may not exist on your product.)
- 5 Eco mode symbol
- 6 Plus key
- 7 Minus key
- 8 Time slice symbol
- 9 Alarm symbol
- 10 End of Cooking Time symbol

11 Cooking Time symbol

12 Program key

i Maximum time that can be set for end of cooking is 5 hours 59 minutes.

Program will be cancelled in case of power failure. You must reprogram the oven.

i While making any setting, related symbols will flash on the display. You must wait for a short time for the settings to take effect.



i If no cooking setting is made, time of the day cannot be set.

i Remaining time will be displayed if cooking time is set when the cooking starts.

Cooking by setting the cooking time;

You can set the oven so that it will stop at the end of the specified time by setting the cooking time on the timer.

1. Select the function for cooking.

2. Touch  until  symbol appears on display for cooking time.

3. Set the cooking time with **+** / **=** keys.

» » After the cooking time is set,  symbol and the time slice will appear on display continuously.

4. Place the dish into the oven and set the temperature with temperature knob. Cooking will start.



» Cooking time starts to count down on display when cooking starts and all parts of time slice symbol is lit. The set cooking time is divided into 4 equal parts and when the time of each parts

ends, the symbol of that parts turns off. So you can understand the ratio of remaining cooking time to total cooking time easily.

Setting the the end of cooking time to a later time;



After setting the cooking time on the timer, you can set the end of cooking time to a later time.

1. Select the function for cooking.

2. Touch  until  symbol appears on display for cooking time.

3. Set the cooking time with **+** / **=** keys.

» » Once the Cooking Time is set,  symbol will appear on display continuously.

4. Touch  until  symbol appears on display for the end of cooking time.

5. Press **+** / **=** keys to set the end of cooking time.

» After the cooking time is set,  symbol plus  symbol and the time slice will appear on display continuously. Once the cooking starts,  symbol disappears.

6. Place the dish into the oven and set the temperature with temperature knob. Cooking will start.

» **Oven timer calculates the startup time by deducting the cooking time you have set.** Selected operating mode is activated when the startup time of cooking has come and the oven is heated up to the set temperature. It maintains this temperature until the end of cooking time.

» Cooking time starts to count down on display when cooking starts and all parts of time slice symbol is lit. The set cooking time is divided into 4 equal parts and when the time of each parts ends, the symbol of that parts turns off. So you can understand the ratio of



remaining cooking time to total cooking time easily.

- After the cooking process is completed, "End" appears on the display and the timer gives an audio warning.
- Audio warning sounds for 2 minutes. To stop the audio warning, just press any key. Audio warning will be silenced and current time will be displayed.

i If you press any key at the end of the audio warning, the oven will restart operating. Turn the temperature knob and function knob to "0" (off) position to switch off the oven in order to prevent re-operation of the oven at the end of warning.



Activating the keylock

You can prevent digital timer from being intervened with by activating the key lock function.

- Touch  until  symbol appears on display.
» "OFF" will appear on the display.
- Press **+** to activate the key lock.
» Once the key lock is activated, "On" appears on the display and the  symbol remains lit.

i Digital timer keys are not functional when the key lock is activated. Key lock will not be cancelled in case of power failure.



To deactivate the keylock

- Touch  until  symbol appears on display.
» "On" will appear on the display.
- Disable the key lock by pressing the **-** key.
» "OFF" will be displayed once the keylock is deactivated.

Setting the alarm clock

You can use the timer of the product for any warning or reminder apart from the cooking program.

The alarm clock has no influence on the functions of the oven. It is only used as a warning. For example, this is useful when you want to turn food in the oven at a certain point of time. Timer will give an audio warning at the end of the set time.

- Touch  until  symbol appears on display.

i Maximum alarm time can be 23 hours and 59 minutes.

- Set the alarm duration by using **+** / **-** keys.

i Function keys for alarm tone, time of day, display brightness and temperature keys should be at 0 (OFF) position.



»  symbol will remain lit and the alarm time will appear on the display once the alarm time is set.

- At the end of the alarm time,  symbol starts flashing and the audio warning is heard.

Turning off the alarm

- Audio warning sounds for 2 minutes. To stop the audio warning, just press any key.
» Audio warning will be silenced and current time will be displayed.

Cancelling the alarm;

- Touch  until  symbol appears on display in order to cancel the alarm.
- Press and hold **-** key until "00:00" is displayed.

i Alarm time will be displayed. If the alarm time and cooking time are set concurrently, shortest time will be displayed.

Changing alarm tone

1. Touch until symbol appears on display.
 2. Adjust the desired alarm tone with **+** / **-** keys.
 3. The tone you have set will be activated in a short time.
- » Selected alarm tone will appear as "b-01", "b-02" or "b-03" on the display.

Changing the time of the day

To change the time of the day you have previously set:

1. Touch until symbol appears on display.
2. Set the time of the day with **+** / **-** keys.
3. The time you have set will be activated in a short time.

Economy mode

You can save energy with economy mode while cooking by setting cooking time in the oven.

This mode completes the cooking with the inner temperature of the oven by switching off the heaters before the end of cooking time.

Setting the economy mode

1. Touch symbol until **eco** symbol appears on display.
- » "OFF" will appear on the display.
2. Enable economy mode by touching **+** key.

» Once the economy mode is activated, "On" appears on the display and the eco symbol remains lit.

Disabling economy mode

1. Touch symbol until **eco** symbol appears on display.
- » "On" will appear on the display.
2. Disable economy mode by touching **-** key.
- » "Off" will be displayed once the eco mode is deactivated.

Setting the screen brightness (This feature is optional. It may not exist on your product.)

1. Touch until d-01 or d-02 or d-03 appears on display for display brightness.
 2. Set the desired brightness with **+** / **-** keys.
- » The time you have set will be activated in a short time.

Cooking times table























The timings in this chart are meant as a guide. Timings may vary due to temperature of food, thickness, type and your own preference of cooking.





Baking and roasting



1st rack of the oven is the **bottom** rack.

Dish	Cooking level number	Accessory to use	Operating mode	Rack position	Temperature (°C)	Cooking time (approx. in min.)
Cakes in tray	One level	Standard tray*		3	180	25 ... 30
Cakes in mould	One level	Cake mold on wire grill**		2	180	40 ... 50
Small cakes	One level	Standard tray*		3	160	25 ... 35
	One level	Standard tray*		3	150	30 ... 40
	2 levels	1-Pastry tray* 3-Standard tray*		1 - 3	150	35 ... 50
	3 levels	1-Standard tray* 3-Pastry tray* 5-Deep tray*		1 - 3 - 5	150	35 ... 50













Dish	Cooking level number	Accessory to use	Operating mode	Rack position	Temperature (°C)	Cooking time (approx. in min.)
Sponge cake	One level	Round springform pan with a diameter of 26 cm on wire grill**		3	160	25 ... 35
	One level	Round springform pan with a diameter of 26 cm on wire grill**		2	150	30 ... 40
	2 levels	1-Round springform pan with a diameter of 26 cm on wire grill** 4-Round springform pan with a diameter of 26 cm on pastry tray**		1 - 4	150	35 ... 45
Cookies	One level	Pastry tray*		3	180	25 ... 30
	2 levels	1-Pastry tray* 3-Standard tray*		1 - 3	180	30 ... 40
	3 levels	1-Pastry tray* 3-Standard tray* 5-Deep tray*		1 - 3 - 5	180	35 ... 45
Dough pastry	One level	Standard tray*		2	200	30 ... 40
	2 levels	1-Pastry tray* 5-Standard tray*		1 - 5	200	45 ... 55
	3 levels	1-Pastry tray* 3-Standard tray* 5-Deep tray*		1 - 3 - 5	200	55 ... 65
Rich pastry	One level	Standard tray*		2	200	25 ... 35
	2 levels	1-Pastry tray* 3-Standard tray*		1 - 3	200	35 ... 45
	3 levels	1-Pastry tray* 3-Standard tray* 5-Deep tray*		1 - 3 - 5	190	45 ... 55
Leaven	One level	Standard tray*		2	200	35 ... 45
Lasagna	One level	Glass/metal rectangular pan on wire grill**		2 - 3	200	30 ... 40
Pizza	One level	Standard tray*		2	200 ... 220	15 ... 20
Beef steak (whole) / Roast	One level	Standard tray*		3	25 min. 250/max, then 180 ... 190	100 ... 120
Leg of Lamb (casserole)	One level	Standard tray*		3	25 min. 250/max, then 190	70 ... 90
	One level	Standard tray*		3	25 min. 250/max, then 190	60 ... 80
Roasted chicken (1,8-2 kg)	One level	Standard tray*		2	15 min. 250/max, then 180 ... 190	60 ... 80
	One level	Standard tray*		2	15 min. 250/max, then 180 ... 190	60 ... 80



Dish	Cooking level number	Accessory to use	Operating mode	Rack position	Temperature (°C)	Cooking time (approx. in min.)
Turkey (5.5 kg)	One level	Standard tray*		1	25 min. 250/max, then 180 ... 190	150 ... 210
	One level	Standard tray*		1	25 min. 250/max, then 180 ... 190	150 ... 210
Fish	One level	Standard tray*		3	200	20 ... 30
	One level	Standard tray*		3	200	20 ... 30

It is suggested to perform preheating for all foods.
* These accessories may not be supplied with the product.
** These accessories are not supplied with the product. They are commercially available accessories.

Cooking table for test meals

Meals in this cooking table are prepared according to EN 60350-1 to make it easier for control institutes to test the product.

Dish	Cooking level number	Accessory to use	Operating mode	Rack position	Temperature (°C)	Cooking time (approx. in min.)
Shortbread	One level	Standard tray*		3	140	20 ... 30
	One level	Standard tray*		3	140	20 ... 30
	2 levels	1-Standard tray* 3-Pastry tray*		1 - 3	140	20 ... 30
	3 levels	1-Standard tray* 3-Pastry tray* 5-Deep tray*		1 - 3 - 5	140	25 ... 35
Small cakes	One level	Standard tray*		3	160	25 ... 35
	One level	Standard tray*		3	150	30 ... 40
	2 levels	1-Pastry tray* 3-Standard tray*		1 - 3	150	35 ... 50
	3 levels	1-Standard tray* 3-Pastry tray* 5-Deep tray*		1 - 3 - 5	150	35 ... 50
Sponge cake	One level	Round springform pan with a diameter of 26 cm on wire grill**		3	160	25 ... 35
	One level	Round springform pan with a diameter of 26 cm on wire grill**		2	150	30 ... 40
	2 levels	1-Round springform pan with a diameter of 26 cm on wire grill** 4-Round springform pan with a diameter of 26 cm on pastry tray**		1 - 4	150	35 ... 45
Apple pie	One level	Round black metal dish with a diameter of 20 cm on wire grill**		2	180	50 ... 60

Dish	Cooking level number	Accessory to use	Operating mode	Rack position	Temperature (°C)	Cooking time (approx. in min.)
	One level	Round black metal dish with a diameter of 20 cm on wire grill**		2	170	50 ... 60
	2 levels	1-Round black metal dish with a diameter of 20 cm on wire grill** 4-Round black metal dish with a diameter of 20 cm on pastry tray**		1 - 4	170	50 ... 60

It is suggested to perform preheating for all foods.
* These accessories may not be supplied with the product.
** These accessories are not supplied with the product. They are commercially available accessories.

Tips for baking cake

- If the cake is too dry, increase the temperature by 10°C and decrease the cooking time.
- If the cake is wet, use less liquid or lower the temperature by 10°C.
- If the cake is too dark on top, place it on a lower rack, lower the temperature and increase the cooking time.
- If cooked well on the inside but sticky on the outside use less liquid, lower the temperature and increase the cooking time.

Tips for baking pastry

- If the pastry is too dry, increase the temperature by 10°C and decrease the cooking time. Dampen the layers of dough with a sauce composed of milk, oil, egg and yoghurt.
- If the pastry takes too long to bake, pay care that the thickness of the pastry you have prepared does not exceed the depth of the tray.
- If the upper side of the pastry gets browned, but the lower part is not cooked, make sure that the amount of sauce you have used for the pastry is not too much at the bottom of the pastry. Try to scatter the sauce equally

between the dough layers and on the top of pastry for an even browning.



Cook the pastry in accordance with the mode and temperature given in the cooking table. If the bottom part is still not browned enough, place it on one lower rack next time.

Tips for cooking vegetables

- If the vegetable dish runs out of juice and gets too dry, cook it in a pan with a lid instead of a tray. Closed vessels will preserve the juice of the dish.
- If a vegetable dish does not get cooked, boil the vegetables beforehand or prepare them like canned food and put in the oven.

How to operate the grill



Close oven door during grilling.
Hot surfaces may cause burns!

Switching on the grill

1. Turn the Function knob to the desired grill symbol.
 2. Then, select the desired grilling temperature.
 3. If required, perform a preheating of about 5 minutes.
- » Temperature light turns on.

Cooking times table for grilling

Grilling with electric grill

Food	Accessory to use	Rack position	Recommended temperature (°C)**	Cooking time (approx. in min.)
Fish	Wire grill	4...5	250	20...25 min. #
Sliced chicken	Wire grill	4...5	250	25...35 min.
Lamb chops	Wire grill	4...5	250	20...25 min.
Roast beef	Wire grill	4...5	250	25...30 min. #
Veal chops	Wire grill	4...5	250	25...30 min. #
Toast bread*	Wire grill	4	250	1...3 min.

depending on thickness

*Preheat for 5 minutes

**If the grill temperature of your product cannot be adjusted, the grill will work at the recommended temperature.

Meals in this cooking table are prepared easier for control institutes to test the according to EN 60350-1 to make it product.

Food	Accessory to use	Rack position	Temperature (°C)	Cooking time (approx. in min.)
Toast bread	Wire grill	4	250	1...3 min.
Meatballs (beef) - 12 pieces	Wire grill	4	250	25...35 min.

Turn the food after 2/3 of the total grilling time.

It is suggested to perform 5 minutes preheating for all foods broiling.

Switching off the grill

1. Turn the Function knob to Off (top) position.



Foods that are not suitable for grilling carry the risk of fire.
Only grill food which is suitable for intensive grilling heat.
Do not place the food too far in the back of the grill. This is the hottest area and fatty food may catch fire.

6 Maintenance and care

General information

Service life of the product will extend and the possibility of problems will decrease if the product is cleaned at regular intervals.



Disconnect the product from mains supply before starting maintenance and cleaning works. There is the risk of electric shock!



Allow the product to cool down before you clean it. Hot surfaces may cause burns!

- Clean the product thoroughly after each use. In this way it will be possible to remove cooking residues more easily, thus avoiding these from burning the next time the appliance is used.
- No special cleaning agents are required for cleaning the product. Use warm water with washing liquid, a soft cloth or sponge to clean the product and wipe it with a dry cloth.
- Always ensure any excess liquid is thoroughly wiped off after cleaning and any spillage is immediately wiped dry.
- Do not use cleaning agents that contain acid or chloride to clean the stainless or inox surfaces and the handle. Use a soft cloth with a liquid detergent (not abrasive) to wipe those parts clean, paying attention to sweep in one direction.



The surface might get damaged by some detergents or cleaning materials.

Do not use aggressive detergents, cleaning powders/creams or any sharp objects during cleaning. Do not use harsh abrasive cleaners or sharp metal scrapers to clean the oven door glass since they can scratch the surface, which may result in shattering of the glass.



Do not use steam cleaners to clean the appliance as this may cause an electric shock.

Cleaning the control panel

Clean the control panel and knobs with a damp cloth and wipe them dry.



If your product is equipped with buttons/knobs do not remove the control buttons/knobs to clean the control panel.

Control panel may get damaged!

Cleaning the oven

To clean the side wall (Varies depending on the product model.) (This feature is optional. It may not exist on your product.)

1. Remove the front section of the side rack by pulling it in the opposite direction of the side wall.
2. Remove the side rack completely by pulling it towards you.

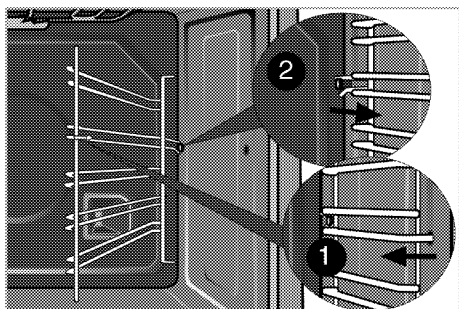

Catalytic walls

(This feature is optional. It may not exist on your product.)

The inner side walls (A) and/or the rear wall (B) of your product may be coated with catalytic enamel. Catalytic walls have a light matte colour and a porous surface. Catalytic walls of the oven should not be cleaned. Thanks to their perforated structure, catalytic surfaces absorb grease and once the surface is filled with grease, they start to shine. In this case, it is recommended to replace the parts.

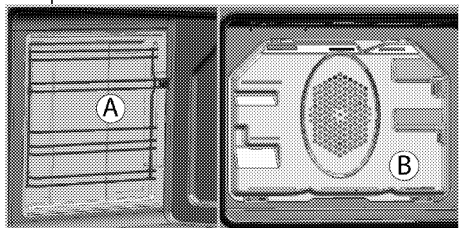

Easy Steam Cleaning

It ensures easy cleaning because the dirt (having waited not for too long) is softened with the steam that forms inside the oven and the water drops condensing on the inner surfaces of the oven.

1. Remove all accessories inside the oven.
2. Pour 500 ml of water into the oven tray and place the tray at the 2nd rack of the oven.

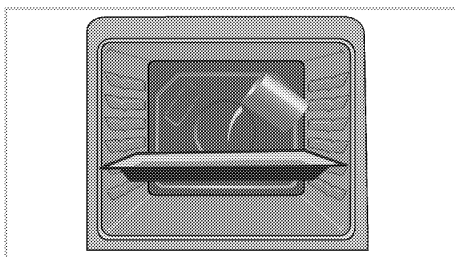

3. Set the oven to easy steam cleaning mode and run at 100°C for 25 minutes.
4. Open the door and wipe the inner surfaces of the oven with a damp sponge or cloth.
5. Use warm water with washing liquid, a soft cloth or sponge to clean the persistent dirt and wipe it with a dry cloth.

i During the easy steam cleaning mode, water that is placed in the tray to soften lightly formed residues/dirt within the oven cavity will evaporate and condense in the oven cavity and inner glass of the oven door, therefore water may drip when the oven door is opened. Wipe away the condensation as soon as the oven door is opened.

Clean oven door

To clean the oven door, use warm water with washing liquid, a soft cloth or sponge to clean the product and wipe it with a dry cloth.

i Don't use any harsh abrasive cleaners or sharp metal scrapers for cleaning the oven door. They could scratch the surface and destroy the glass.

Removing the oven door

1. Open the front door (1).
2. Open the clips at the hinge housing (2) on the right and left hand sides of the

front door by pressing them down as illustrated in the figure.

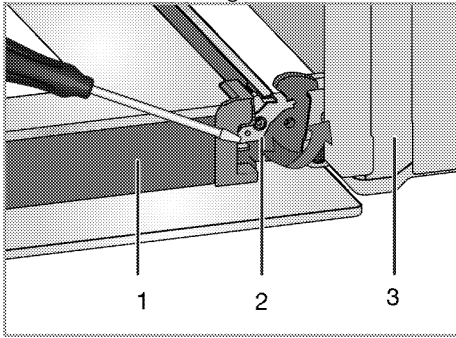

- 1 Door
- 2 Hinge lock(closed position)
- 3 Oven
- 4 Hinge lock(open position)

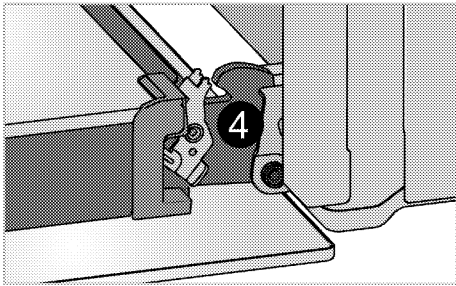

3. Move the front door to half-way.

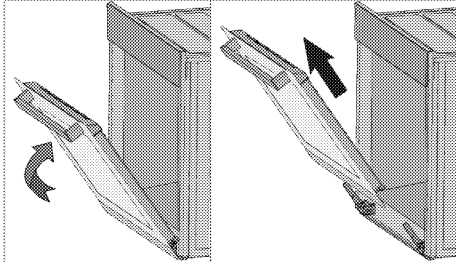

4. Remove the front door by pulling it upwards to release it from the right and left hinges.

i Steps carried out during removing process should be performed in reverse order to install the door. Do not forget to close the clips at the hinge housing when reinstalling the door.

Removing the door inner glass

(This feature is optional. It may not exist on your product.)

The inner glass panel of the oven door can be removed for cleaning.

1. Open the oven door.

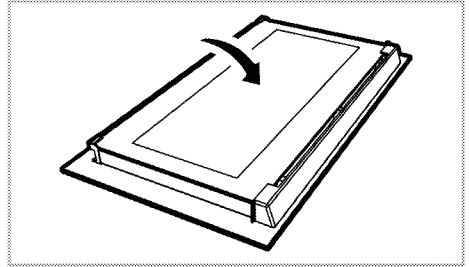

2. Pull towards yourself and remove the plastic part installed to upper section of the front door.

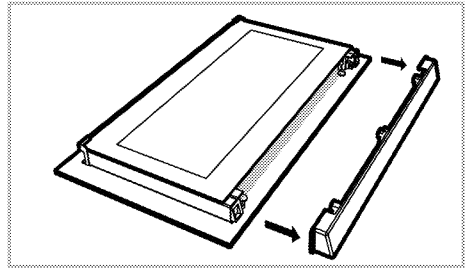

3. As illustrated in figure, raise the innermost glass panel (1) slightly in direction **A** and pull it out in direction **B**.

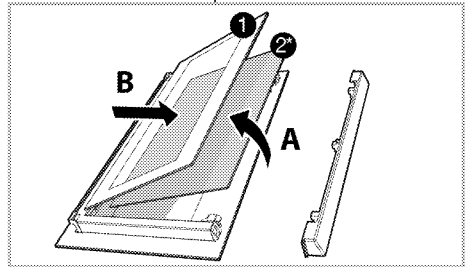

- 1 Innermost glass panel
- 2* Inner glass panel (This may not exist on your product.)
- 4. If your product is equipped with an inner glass panel; repeat the same

procedure to remove the inner glass panel (2).

5. The first step to regroup the door is reinstalling inner glass panel (2). Place the chamfered corner of the glass panel so that it will rest in the chamfered corner of the plastic. (If your product is equipped with an inner glass panel). Inner glass panel (2) must be installed into the plastic slot close the innermost glass panel (1).
6. When installing the innermost glass panel (1), make sure that the printed side of the panel faces towards the inner glass panel. It is important to seat lower corner of innermost glass panel (1) into the lower plastic slot.
7. Push the plastic part towards the frame until you hear a "click".

Replacing the oven lamp

! Before replacing the oven lamp, make sure that the product is disconnected from mains and cooled down in order to avoid the risk of an electrical shock.
Hot surfaces may cause burns!

i Position of lamp might vary from the figure.

i In this oven, an incandescent lamp with a power of less than 40 W, a height of less than 60 mm, a diameter of less than 30 mm or a halogen lamp with socket type G9, a power of less than 60 W is used. The lamps are suitable for operation at temperatures above 300 °C. Oven lamps can be obtained from Authorised Service Agents or technician with licence.

i The lamp used in this appliance is not suitable for household room illumination. The intended purpose of this lamp is to assist the user to see foodstuffs.

i The lamps used in this appliance have to withstand extreme physical conditions such as temperatures above 50 °C.

If your oven is equipped with a round lamp:

1. Disconnect the product from mains.
2. Turn the glass cover counter clockwise to remove it.

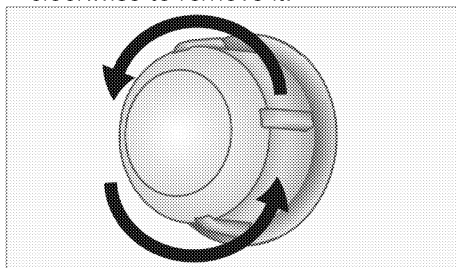

3. If your oven lamp is of type (A) shown in the figure below, remove it by rotating as shown and replace it. If it is of type (B), pull and remove it as shown in the figure and replace it.

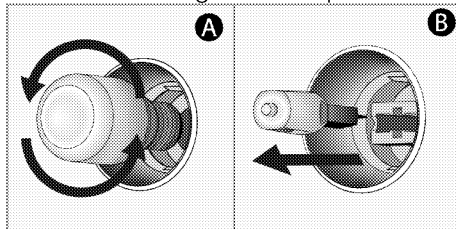

4. Install the glass cover.

7 Troubleshooting

Oven emits steam when it is in use.

- It is normal that steam escapes during operation. >>> *This is not a fault.*

Product emits metal noises while heating and cooling.

- When the metal parts are heated, they may expand and cause noise. >>> *This is not a fault.*

Product does not operate.

- The mains fuse is defective or has tripped. >>> *Check fuses in the fuse box. If necessary, replace or reset them.*
- Product is not plugged into the (grounded) socket. >>> *Check the plug connection.*

Oven light does not work.

- Oven lamp is defective. >>> *Replace oven lamp.*
- Power is cut. >>> *Check if there is power. Check the fuses in the fuse box. If necessary, replace or reset the fuses.*

Oven does not heat.

- Might not be set to a certain cooking function and/or temperature. >>> *Set the oven to a certain cooking function and/or temperature.*
- In models equipped with a timer, the timer is not adjusted. >>> *Adjust the time.* (In products with microwave oven, timer controls only microwave oven.)
- Power is cut. >>> *Check if there is power. Check the fuses in the fuse box. If necessary, replace or reset the fuses.*

(In models with timer) Clock display is blinking or clock symbol is on.

- A previous power outage has occurred. >>> *Adjust the time / Switch of the product and switch it on again.*



Consult the Authorised Service Agent or technician with licence or the dealer where you have purchased the product if you can not remedy the trouble although you have implemented the instructions in this section. Never attempt to repair a defective product yourself.



**The widest service center network in the country with
more than 200 outlets**



**Dawlance Reliable service is available for all
household products**

Services at your doorstep within 24 hours

**Call Center Services available all week
from 8:30am to 8:30pm**

Service UAN # 021-111-11-7359 (RELY)

Head Office: Dawlance Center 7/4, Civil Lines-9

Dr. Ziauddin Ahmed Road, Karachi.

Ph: (021) 35652450-9

E-mail: customer.service@dawlance.com.pk

Website: www.dawlance.com.pk

ڈاؤلینس ریلائبل ہے!