



## Hand Blender

User Manual



HB 6150

EN



01M-8911441100-4621-02

# Please read this guide first!

Dear Customer,

Thank you for choosing an Arçelik product. We would like you to achieve the optimal efficiency from this high quality product which has been manufactured with the state of the art technology. Please make sure you read and understand this guide and supplementary documentation fully before use and keep it as a reference. Include this guide with the unit if you hand it over to someone else. Observe all warnings and information herein and follow the instructions.

Keep in mind that this user guide may apply to several product models. The guide clearly indicates any variations of different models.

## Symbols and their meanings

Following symbols have been used throughout this guide:



Important information and beneficial advices regarding the usage of the device.



**WARNING:** Warnings about hazards to life and property.



Suitable for contact with food.



Do not immerse the appliance, the power cord or the plug in water or in any other liquids.



Protection class against electric shock.



Warning of electric shock.



**RECYCLED &  
RECYCLABLE  
PAPER**

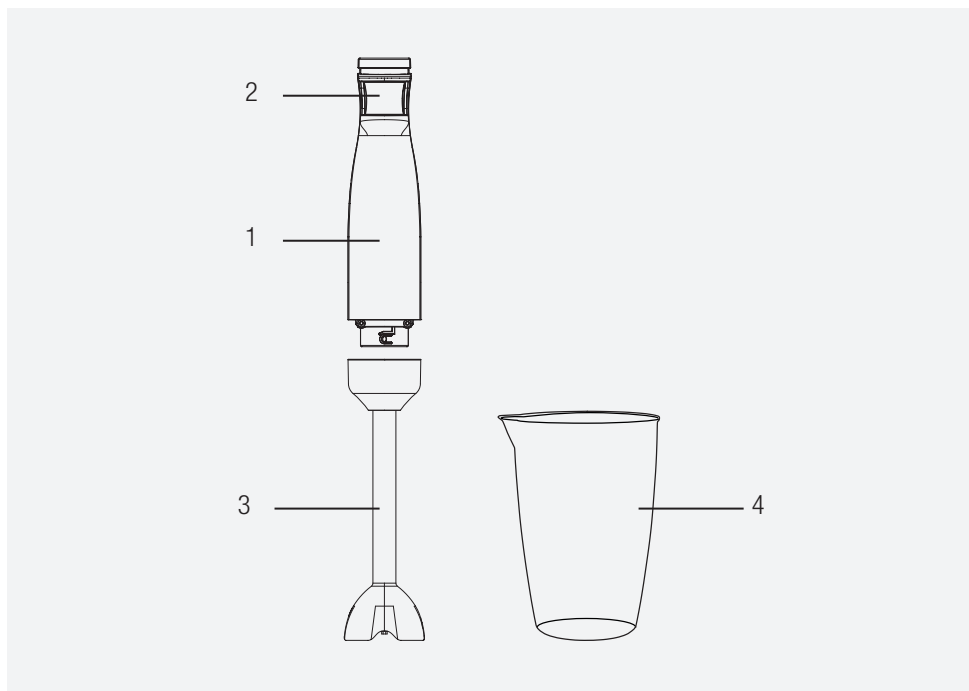

1. Motor body
2. Start/Turbo Button
3. Chopping Blade
4. Measuring cup

## Technical data

<b>Model</b>	HB 6280
<b>Power Source</b>	220-240 V~, 50-60 Hz
<b>Power</b>	800 W
<b>Insulation class</b>	II

The rights to make technical and design changes are reserved.

The values provided with the appliance or its accompanying documents are laboratory readings in accordance with the respective standards. These values may differ depending on the use and ambient conditions.

# CONTENTS

---

<b>1 Important safety and environmental instructions</b>	<b>5</b>
1.1 General Safety .....	4
1.2 Compliance with WEEE regulations and waste disposal .....	7
1.3 Packaging information .....	7
1.4 What to do for energy saving .....	7
<b>2 Use</b>	<b>8</b>
2.1 First Operation .....	8
2.2 Intended use.....	8
2.3 Blending.....	8
<b>3 Cleaning and Maintenance</b>	<b>10</b>
3.1 Cleaning.....	10
3.2 Storage .....	11
3.3 Transportation and shipping.....	11
<b>4 Consumer services</b>	<b>12</b>

# 1 Important safety and environmental instructions

This section contains safety instructions to prevent hazards that can result in injury or property damage. Any warranty is void if these instructions are not followed.

## 1.1 General safety

- This appliance complies with international safety standards.
- This appliance is not designed for commercial use, it is intended for use at home and in similar applications as specified below:
  - In personnel kitchen areas in shops, offices and other working areas,
  - Ranches,
  - Areas used by customers in motels and hotels, and other residential settings,
  - Bedrooms and breakfast locations.
- Appliance may be used by persons with limited physical, perceptual or mental abilities or persons with a lack of experience and knowledge if they are supervised or given instructions on the operation of the appliance and any relevant risks they may be encountered. Children should not tamper with the appliance. Cleaning and user maintenance must not be carried out by children. This appliance may not be used by children.
- Store the appliance and its electrical cord out of the reach of children.
- Do not use the appliance if the power cord, the appliance or the appliance blade is damaged. Contact authorised service.
- Use only original parts or parts recommended by the manufacturer.
- Do not disassemble the appliance.
- Your mains power supply should be in align with the specified information on the type tag of the appliance.
- Do not use the appliance with an extension cord.
- Do not unplug the appliance by pulling on the cord.
- When it is left unattended, before attaching/detaching accessories, or before cleaning, wait

# 1 Important safety and environmental instructions

for the moving parts to stop and unplug the power cord of the appliance.

- Do not touch the plug of the appliance while your hands are damp or wet.
- Do not use the appliance for hot meals.
- Warning: Your product is equipped with a safety thermic for protection. Your product will automatically stop due to overheating in long-term use. After a short cooling period, you can restart your appliance.
- Use the appliance only with the provided rubber base and the bowl.
- Do not operate the device for more than 30 seconds without interruption. After starting, let it rest for 3 minutes before using it again. Do not operate the appliance with the empty bowl.
- To avoid damaging the blades and the appliance, remove bones and seeds from foods.
- The appliance is not suitable for dried or rough food that may lead the blades to become blunt very rapidly.
- Follow all warnings to avoid injuries due to misuse.
- Do not touch the accessories while emptying the container, during cleaning and after use, without stopping the blades and unplugging the product. Handle the chopping blade carefully, trying to hold it only by its plastic part.
- After cleaning, dry the appliance and all its components before connecting it to power and installing the components.
- Do not immerse the appliance, the power cord or the plug in water or in any other liquids.
- Do not operate the appliance or its components over or near hot surfaces or do not put on such surfaces.
- If you keep the packaging materials, keep them out of the reach of children.

# 1 Important safety and environmental instructions

## 1.2 Compliance with the WEEE regulations and waste disposal



This product does not contain the dangerous and prohibited materials indicated in "Waste Electrical and Electronic Equipment Control Regulation" published by Ministry of Environment and Urbanisation of the Republic of Turkey. Complies with WEEE Regulations. This product was manufactured from recyclable and reusable high quality parts and materials. Therefore, do not dispose of this product with other domestic wastes at the end of its life cycle. Take it to a collection point for recycling of electrical and electronic equipment. You can ask your local administration about these collection points. You can help protect the environment and natural resources by delivering the used products for recycling.

## 1.3 Packaging information



The product's packaging is made of recyclable materials, in accordance with the National Legislation. Do not dispose of the packaging waste with the household waste or other wastes, dispose it to the packaging collection areas specified by local authorities.

## 1.4 What to do for energy saving

Observe the recommended periods specified in the manual during use. Unplug the appliance after each use.

## 2 Operation

### 2.1 First operation

Remove all packaging and labeling materials and dispose of them in accordance with the applicable law.

Clean the device before using the device for the first time (see "Cleaning and Care").

Use the appliance in an upright position on a stable, flat, clean, dry and non-slip surface.

### 2.2 Intended use

- This appliance is designed for household use only. It should not be used for commercial purposes.
- Do not use the appliance for any purpose other than its intended use.
- This appliance is intended for blending food only.



- Unplug the appliance when not in use.
- When you first press the trigger, it switches to the "operating" position, and when you press the trigger all the way, it switches to the "turbo" function.

### 2.3 Blending

#### Warnings:



- Do not touch the sharp parts of knives with bare hands
- Make sure that the chopping blade is fully seated on the motor unit. Keep the device upright while mixing ingredients in the mixing bowl.

You can use your hand blender to prepare sauces, soups, mayonnaise, baby food, milkshakes, etc.

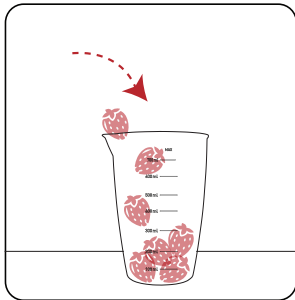

Put small pieces of the food you want to puree or blend into the measuring cup (4).

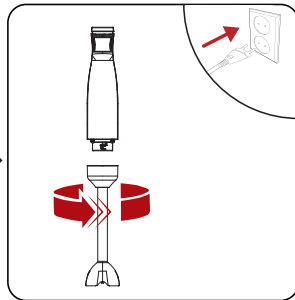

Attach the chopping blade (3) to the motor body (1) by turning it counterclockwise until it locks. Plug in the appliance.

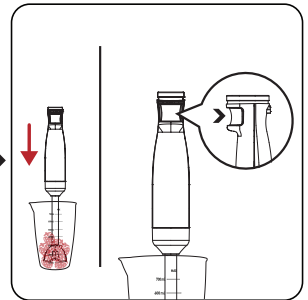

Insert the chopping blade (3) into the measuring cup (4) containing the ingredients and start the device by pressing the low or high speed start button.



## 2 Operation



- If the ingredients stick to the sides of the plastic container, remove them with a spatula and continue mixing.
- Making light circular movements with the device during the procedure will provide a better result.

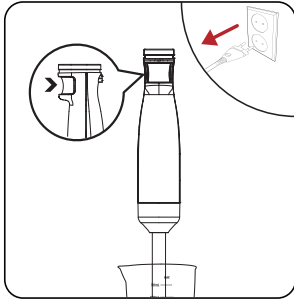

Turn the appliance off and unplug it.

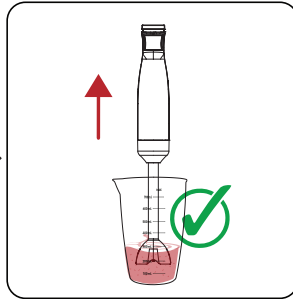

Remove the chopping blade (3) from the measuring cup (4).

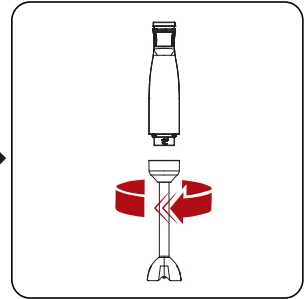

Turn the chopping blade (3) clockwise to detach it from the motor unit (1).

## 3 Cleaning and maintenance

### 3.1 Cleaning

#### Warnings:

- Never use gasoline, solvents, abrasive cleaners, metal objects, or hard brushes to clean the appliance.
- Do not touch the chopping blades with bare hands. The blades are very sharp. Use any brush during cleaning!
- Do not place the product body and the power cord in water or other liquids, do not put them under running water and never put them in the dishwasher.
- You can wash the surfaces of the shredder bar that enter the chamber under the tap, but be careful not to get water on the inner surfaces.

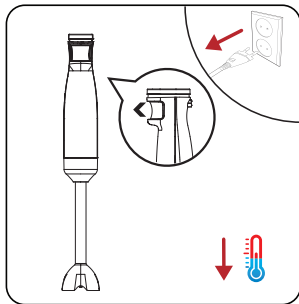

Turn the appliance off and unplug it. Wait for the appliance to completely cool down.



You can wash the chopping blade (3) and the measuring cup (4) with detergent and warm water.



Use a slightly damp cloth to clean the outside of the motor body (1)



It is easier to clean the appliance right after using it.

## **3 Cleaning and maintenance**

---

### **3.2 Storage**

- If you do not plan to use the appliance for a long period of time, please store it carefully.
- Ensure that the appliance is unplugged, cooled down completely.
- Do not wrap its cable around the appliance.
- Store the appliance in a cool and dry environment.
- Keep the appliance out of the reach of children.

### **3.3 Transportation and shipping**

- During transportation and shipping, carry the appliance with its original packaging. The packaging of the appliance will protect the appliance against physical damage.
- Do not place heavy objects on the device or its packaging. The appliance may get damaged.
- If the appliance is dropped, the appliance may not operate or permanent damage may occur.