

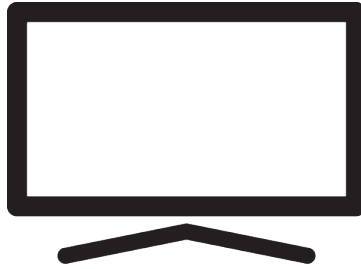

Television

User Manual



A50 E 795 B

EH6T00/ EN/ / 16/12/2024 17:56
EH6T00



Please read this manual first!

Dear Customer,

Thank you for choosing this product. We wish your product, produced with high quality and technology, to offer you the best efficiency. Therefore, carefully read this entire manual and other supplied documentation before using the product and keep it for future reference. If you hand over the appliance to someone else, give them the user manual as well. Follow the instructions by paying attention to all information and warnings specified in the user manual.

Keep in mind that this user guide may apply to several product models.

If the user manual contains more than one model, the differences between the models are clearly specified in the manual.

Symbols and their explanation

There are below symbols in user manual and on the product:





	Risk of death or injury.
	Useful tips on important information or use.
	Electric shock warning.
	Read the user manual.

Table of Contents

1 Safety Instructions	8	3.6.1 DVB-S Satellite Antenna Con- nection	19
1.1 Intended Use.....	8	3.6.2 DVB- T, DVB- C and Analogue Antenna Connection	19
1.2 Electrical Safety.....	8	3.6.3 Electrical Connection.....	19
1.3 Fire Safety.....	9	3.7 Remote Control.....	20
1.4 Transportation Safety.....	9	3.8 On-Screen Keyboard.....	21
1.5 Installation Safety.....	9	4 Settings	22
1.6 Safety of Children, Vulnerable Persons and Pets	9	4.1 Preparation.....	22
1.7 Safety During Maintenance and Cleaning	10	4.2 Initial Set-up and Setting the TV set	22
2 Environmental Instructions and General Information	11	4.3 Editing Digital Channels	27
2.1 Conformity with WEEE Regulation and Disposing of Waste Product..	11	4.3.1 Starting Channel Editor Applica- tion	27
2.2 Information on Used Batteries	11	4.3.2 Tuner Mode Selection.....	27
2.3 Information on the Disposal of the Packaging.....	11	4.3.3 Creating a Favourite List.....	27
2.4 Information on Power Saving	11	4.3.4 Moving A Channel in the Fa- vourites List	28
2.5 Information on PCB Conformity ...	11	4.3.5 Deleting Channels in the Fa- vourites List	28
2.6 Information on Interface Require- ments	11	4.3.6 Move Channel.....	28
2.7 Information on Still Images	12	4.3.7 Changing Channel Location	28
2.8 Information on Electromagnetic interference.....	12	4.3.8 Deleting a Channel	29
2.9 EU Directives.....	12	4.3.9 Deleting a Channel List	29
2.10 Note for Customers in Turkey	12	4.3.10 Edit Channel.....	29
2.14 Notes for WLAN Connection	13	4.3.11 Skip Channel.....	29
2.16 Service Information for Author- ised Dealers	13	4.4 Picture Settings.....	30
3 Your Product	15	4.4.1 Advanced Settings	30
3.1 Contents of the Package	15	4.4.2 Restoring Factory Defaults for Picture Settings	31
3.2 Installation or Hanging.....	16	4.5 Sound Settings.....	32
3.3 Inserting Batteries into the Re- mote Control.....	16	4.5.1 Sound Style.....	32
3.4 Product Introduction	17	4.5.2 Balance	32
3.5 Keypad	18	4.5.3 Bass	32
3.5.1 Switching the Appliance On from the Standby Mode.....	18	4.5.4 Treble	32
3.5.2 Switching and Restoring the Appliance to/from the Sleep Mode.....	18	4.5.5 Surround Sound.....	32
3.5.3 Switching the Appliance to the Standby Mode	18	4.5.6 Equalizer	32
3.6 Connecting the Antenna and the Power Cord	19	4.5.7 Speaker Settings	33
		4.5.8 Speaker Delay.....	33
		4.5.9 eARC	33
		4.5.10 Automatic Volume	33
		4.5.11 Downmix Mode	33
		4.5.12 Dialogue Enhancer	33
		4.5.13 Restoring Factory Defaults for Sound Settings	33
		5 Basic Functions for the Operation of the TV set	34

5.1	Switching on and off	34	7 Electronic TV Guide	43	
5.2	Selecting the TV Mode.....	34	8 HBBTV.....	44	
5.3	Selecting the Signal Source and Antenna Type.....	34	8.1	What is HbbTV?	44
5.4	Selecting Channels.....	34	8.2	Using HbbTV	44
5.5	Selecting Favourites List.....	34	8.3	HBBTV Settings	44
5.6	Setting the Volume.....	34	8.3.1	HBBTV Support	45
5.7	Muting	34	8.3.2	Watching Preferences.....	45
5.8	Eco Mode Settings	34	8.3.3	Cookie Settings	45
5.8.1	Eco Mode	34	8.3.4	Persistent Storage.....	45
5.8.2	Picture Mode.....	34	8.3.5	Block Tracking Sites	45
5.8.3	Backlight.....	35	8.3.6	Device ID	45
5.8.4	Smart Backlight.....	35	8.3.7	Reset Device ID.....	45
5.9	Changing the Picture Format.....	35	9 Teletext	47	
5.10	Parental Controls.....	35	9.1	TOP Text or FLOF Text Mode.....	47
5.10.1	Blocking a TV Channel	36	9.2	Normal Text Mode.....	47
5.10.2	Watching a Blocked TV Chan- nel	36	10 USB Recording	48	
5.10.3	Programme Restrictions	36	10.1	Information on Recording and Playing Television Programmes.	48
5.10.4	Blocking an External Source	36	10.2	Possible Limitations When Us- ing an External Data Medium.....	48
5.10.5	Watching a Blocked External Source.....	36	10.3	Connecting External Data Media	48
6 Advanced Functions for the Opera- tion of the TV set	38		10.4	USB Recording Settings	49
6.1	Changing the Audio Language	38	10.4.1	Formatting the Data Medium	49
6.2	Audio Language.....	38	10.4.2	Selecting Data Medium for Re- cord/Time shift.....	50
6.3	Audio File Type	38	10.4.3	Data Medium Test.....	50
6.4	Visually impaired	39	10.5	Turning the Time Shift Function On/off	50
6.5	Subtitles	39	10.6	Disk Setup the Time Shift Drive..	50
6.5.1	Analogue Subtitle.....	39	10.6.1	Automatic Installation.....	50
6.5.2	Digital Subtitle	39	10.6.2	Manual Set-up	50
6.5.3	Digital Subtitle Language	39	10.7	Pausing Programs with Time Shift and Continuous Recording.	51
6.5.4	Second Digital Subtitle Lan- guage	39	10.8	Recording Programmes	52
6.6	Teletext Language Selection	39	10.8.1	Switching the TV to Standby During Recording.....	52
6.6.1	Digital Teletext Language.....	39	10.8.2	Recording a Programme from the Channel List.....	52
6.6.2	Page Decoding Language	40	10.9	Sleep Timer	52
6.7	Blue Screen.....	40	10.9.1	Scheduling a Record	52
6.8	Automatic shut down when no signal.....	40	10.9.2	Adding a Record Timer Using the Electronic Programme Guide	52
6.9	Default Channel	40	10.9.3	Adding a Record Timer By En- tering the Information Manually	53
6.10	BISS Key.....	40	10.9.4	Editing the Recording Timer	54
6.11	TKGS Settings.....	41			
6.11.1	Operation Mode	41			
6.11.2	TKGS Locator List.....	41			
6.11.3	Resetting Table Version	42			
6.12	Signal Information.....	42			
6.13	Open Source Licenses	42			

10.9.5	Deleting a Recording Timer.....	54	12.10	Applications.....	66
10.10	Playback.....	54	12.10.1	Downloading Applications from Google Apps.....	66
10.10.1	Playing a Recording from the List of Recorded Files.....	54	12.10.2	Starting an Installed Application.....	66
10.10.2	Forward/Reverse Picture Search.....	54	12.10.3	Sorting the Applications on Home Menu.....	66
10.11	Deleting Broadcasts from the Recorded Files List.....	55	12.11	Application Settings.....	66
11	USB Player.....	56	12.11.1	Removing Installed Applications.....	67
11.1	File Formats.....	56	12.11.2	Force Quitting of Applications.....	67
11.1.1	Video Data.....	56	12.11.3	Clearing Application Data.....	67
11.1.2	Audio Data.....	56	12.11.4	Clearing the Application Cache.....	67
11.1.3	Picture Data.....	56	12.11.5	Application Default Settings ...	67
11.2	Connecting External Data Media..	56	12.11.6	App Notifications.....	67
11.3	Removing the External Data Medium.....	57	12.11.7	Managing Application Updates.....	68
11.4	Multi Media Player menu.....	57	12.11.8	App Permissions.....	68
11.5	Playback - Basic functions.....	58	12.11.9	Special Application Access.....	68
11.6	Additional Playback Functions.....	58	12.11.10	Application Security and Restrictions.....	68
11.6.1	Viewing Information in All File Formats.....	58	13	Google Cast™.....	69
11.6.2	Forward/Reverse Picture Search.....	58	13.1	Turning TV on with Google Cast...	69
11.6.3	Moving to a Specific Time in a Video.....	59	13.2	Using Google Cast on Android or iOS Mobile Device.....	69
11.6.4	Repeat Function.....	59	13.3	Casting the Chrome Browser Tab on your TV via PC.....	69
11.6.5	Picture Settings In Video Files..	59	13.4	Casting Computer Screen on TV ..	70
11.6.6	Sound Settings in Video and Audio Files.....	59	13.5	Casting Music or Video Files from the Computer to the TV.....	70
11.6.7	Shuffling on Audio Files.....	59	14	System Settings.....	71
11.6.8	Playing Audio Files with the Screen Off.....	59	14.1	Ambience mode.....	71
11.6.9	Rotating the Picture Display.....	59	14.2	Power and Energy.....	71
11.6.10	Enlarging the Picture Display (Zoom).....	60	14.2.1	Energy Modes.....	71
12	Google TV™.....	61	14.2.2	Off Timer.....	71
12.1	Terms, Conditions and Privacy ..	61	14.2.3	Power on Behavior.....	72
12.2	Signing in with Google account ..	61	14.2.4	Scheduled Power On / Off.....	72
12.3	Adding a Different Google Account.....	62	14.2.5	Advanced Settings.....	72
12.4	Adding a Google Account for Children.....	62	14.3	About.....	72
12.5	Changing User Accounts.....	63	14.3.1	System update.....	73
12.6	Removing User Accounts.....	63	14.3.2	Change Device Name.....	73
12.7	User Account Settings.....	63	14.3.3	Factory Reset.....	73
12.8	Home Menu (Home Screen).....	64	14.3.4	Viewing Status Information.....	73
12.9	Opening the Home menu.....	64	14.3.5	Viewing Legal Information.....	73
			14.3.6	Viewing Other Information.....	74
			14.4	Date and Time Settings.....	74

14.4.1	Automatic Date and Time Setting	74	18.3	Connecting an External Device with Digital Audio and Image Signal	84
14.4.2	Manual Date and Time Setting	74	18.4	Using a DVD Recorder, DVD Player or Video Recorder	85
14.4.3	Setting Time Zone	74	18.5	Connecting Digital Multi-Channel Amplifier/AV Receiver	85
14.4.4	Setting Time Format	75	18.6	CY (Common Interface)	85
14.5	Language Settings	75	18.6.1	What is Common Interface?	85
14.6	Keyboard Settings	75	18.6.2	Inserting the CA module	85
14.6.1	Available Keyboard Settings	75	18.6.3	Access Control for CA Module and Smart Cards	85
14.6.2	Gboard Settings	75			
14.6.3	Manage Keyboards	76	19 Network Setup	87	
14.7	Storage Settings	76	19.1	Wired Network Connection	87
14.7.1	Internal Storage Area	76	19.2	Wired Network Settings	87
14.7.2	Removable Storage Area	76	19.2.1	Automatic Connection	87
14.7.3	Using Removable Storage Area As Internal Storage Area	76	19.2.2	Manual Connection	87
14.8	Streaming	77	19.3	Wireless Network Connection	88
14.9	System Sounds	77	19.4	Wireless Network Settings	88
14.10	Restart	77	19.4.1	Technical Requirements	88
15 Privacy Settings	78		19.4.2	Auto Connection By Entering the Network Password	88
15.1	Location Settings	78	19.4.3	Connecting to a Hidden Wireless Network	89
15.2	Microphone	78	19.4.4	Manual Connection By Entering the Network Password	89
15.3	Camera	78	19.4.5	Proxy Settings	90
15.4	Usage and Diagnostic settings	79	20 Detailed Channel Settings	91	
15.5	Ads	79	20.1	Automatic Search for Digital Television Channels with Single Satellite Connection	91
15.5.1	Reset Ad ID	79	20.2	Manual Search for Digital Television Channels with Single Satellite Connection	92
15.5.2	Delete Ad ID	79	20.3	Antenna Settings for Digital Satellite Channels and Searching for Channels Automatically with DiSEqC 1.0/1.1	93
15.6	Google Assistant Settings	79	20.4	Antenna Settings for Digital Satellite Channels and Searching for Channels Automatically with the Single Channel Router (SCR) system	94
15.7	Payment and Purchasing Transactions	80	20.5	Motorized Antenna Settings	96
15.8	Application Settings	80	20.6	Searching for Newly Added Digital Channels with Satellite Update	98
16 Remote Controls and Accessories..	81				
17 Help and Feedback	82				
18 Using an External Device	83				
18.1	CEC (Consumer Electronics Control)	83			
18.1.1	Switching the External Device On from the Standby Mode	83			
18.1.2	Selecting the HDMI Source	83			
18.1.3	Selecting the Menu Language ..	83			
18.1.4	Switching the External Device to Standby Mode	83			
18.1.5	Enabling the Control of a HDMI CEC Device	83			
18.2	Connection Options	84			

20.7	Searching for Cable-Connected Digital Television Channels Automatically	98
20.8	Searching for Cable-Connected Digital Television Channels Manually	99
20.9	Setting Up Antenna-Connected Digital Television Channels Automatically	100
20.10	Updating Antenna-Connected Digital Television Channels Automatically	101
20.11	Setting Up Antenna-Connected Digital Television Channels Manually	102
20.12	Setting Up Antenna-Connected Analogue Television Channels Automatically	102
20.13	Updating Antenna-Connected Analogue Television Channels Automatically	103
20.14	Setting Up Antenna-Connected Analogue Television Channels Manually	103
21	Additional Information	105
22	Glossary.....	106
23	Troubleshooting.....	110



1 Safety Instructions

This section includes the safety instructions that will help prevent personal injury or material damage risks.

Our company cannot be held responsible for the damages that might occur due to failure to observe these instructions.

- Always let the authorized service perform installation and repair works.
- Use only the original spare parts and accessories.
- Do not repair or replace any part of the product unless specified expressly in the user manual.
- Do not perform any modifications on the product.



1.1 Intended Use

- This appliance is designed for use in dry rooms.
- Use the product with the supplied stand or a suitable VESA bracket.
- The product is primarily intended for the playback of TV programs, streaming content and music/video material from external devices. Any other use is strictly prohibited.
- It is not intended as an information display or for predominant use as a computer monitor. If a still image or a non-full-format image is displayed for an extended period, visible traces may remain on the screen for some time. This is not a defect that can be used as the basis for a warranty claim.



1.2 Electrical Safety



IMPORTANT SAFETY INSTRUCTIONS. KEEP THESE INSTRUCTIONS FOR FUTURE REFERENCE. Immediately followed by: Read all security warnings, instructions, illustrations and specifications provided with this appliance.

- The product shall not be plugged into the outlet during installation, maintenance, cleaning, repair, and transportation operations.
- Standby LED is off when the mains plug is disconnected. If the Standby LED is lit then it means that your product is connected to the mains.
- Do not dismantle the product. Security risks may arise and also the guarantee of the product can become void if the television is dismantled.
- The product can only be operated with the power cord or the AC/DC adapter supplied with the product.
- Do not operate the product with a damaged power cord/AC/DC adaptor (if supplied).
- If the plug on the product has an earthing contact, only insert the plug into a socket with an earthing contact.
- Only plug the product into the mains socket after you have connected the external devices and the antenna.
- If the power the cord is damaged, it shall be replaced by authorized service only to avoid any risk that may occur.
- Do not jam the power cord under and behind the product. Do not put a heavy object on the power cord.
- The power cord should not be bent, crushed, and come into contact with any heat source.
- Never use an extension cord or a multi socket to operate your appliance.
- The product shall not be supplied with an external switching device such as a timer or it shall not be connect it to a circuit that is regularly turned on and off by a device.
- The plug of the product shall be in an easily accessible place. If this is not possible, there should be a mechanism (fuse, switch, switch, etc.) on the electrical installation to which the product is connected.

ted, in compliance with the electrical regulations and separating all poles from the network.

- Do not touch the plug of the product with wet hands.
- Do not unplug the product by holding the cable, hold the plug to unplug the product.

1.3 Fire Safety

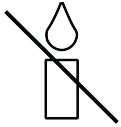

To prevent the spread of fire, keep candles or other open flames away from this product at all times

- Do not cover the ventilation slots on the product.
- Always unplug the power plug and antenna plug during lightning and thunderstorm.
- Keep candles or other open flames away from the TV set.
- Do not expose the batteries to extreme heat such as sunlight, fire or the like.
- Only use batteries of the same type (brand, size, properties). Do not use used and new batteries together.
- Protect the product from moisture. Do not place any vessels filled with water (such as vases) on the product.

1.4 Transportation Safety

- Unplug the product before transportation.
- Disconnect antenna cable and other external devices connected to the product.
- Keep the product in its original packaging if it is available, or wrap it in bubble wrap or thick cardboard if the original packaging is not available.
- Take required precautions against falling and tipping of the product. Do not bump or drop the product while carrying it.

1.5 Installation Safety

- Do not install the product on an unstable surface. Otherwise, the TV may fall, causing serious injury and death.
- Ensure that the furniture you will place the product can safely support the TV set.
- Make sure that the edges of the product does not protrude beyond the dimensions of the furniture on which it is placed.
- Do not place the product on tall furniture that has the risk of tipping over such as cabinets, sideboards, or bookcases. If you have no other choice, fix the furniture and the TV to the wall to prevent them from tipping over.
- Do not place product on fabric or other materials located between the product and furniture.
- Do not place the product next to heating units or in direct sunlight.
- To ensure adequate ventilation, maintain clearance of at least 10 cm around the product.
- Some furniture surfaces may discolor when they come in contact with rubber. To protect furniture, you can place a sheet made of glass or plastic under the stand. Do not use textile underlays or mats such as doilies.
- Consider the above mentioned warnings whenever you change the location of the product.

1.6 Safety of Children, Vulnerable Persons and Pets

- Electrical appliance are dangerous for children and pets. Children and pets must not play with or climb on the product.
- Instruct children that there is danger associated with climbing on furniture when the TV set is to be reached.
- Cleaning and user maintenance should not be performed by children unless there is someone overseeing them.

- Keep the packaging materials out of the reach of children. There is a hazard of injury and suffocation.
- Before disposing of the product, cut the power cord and render it non-functional for children's safety.



1.7 Safety During Maintenance and Cleaning

WARNING: Unplug the product during installation, maintenance, cleaning and repairing procedures.

- Clean the cabinet of the product with a dry or a lightly dampened soft cloth.
- Do not use wet cloths and detergents (Glass Cleaning detergents, cologne, and all other cleaning chemicals).
- Clean the display of the product by wiping with a damp cloth. Do not use water or water with detergent.
- Do not use any detergents containing alcohol, spirit, ammonia, or abrasive agents while cleaning.

2 Environmental Instructions and General Information

2.1 Conformity with WEEE Regulation and Disposing of Waste Product

This product does not contain hazardous and prohibited substances specified in the "Regulations for Supervision of Waste Electrical and Electronic Equipment" published by Turkish Ministry of Environment and Urban Planning. Conforms the WEEE Regulation.



This product has been made from high-quality parts and materials which can be recycled and re-used. Therefore, do not throw the product away with household waste and other

waste at the end of its life. Take it to a collection point for recycling electrical and electronic devices. Contact your local authority for the collection points in your region. Help preserve the nature and natural resources by recycling used products. Before disposing of the product, cut the power cord and render it non-functional for children's safety.

2.2 Information on Used Batteries



Do not dispose of batteries with the household waste. Used batteries must be returned to retail stores or public collection points. You can help to protect the environment in

this way

This symbol on the battery or on the packaging indicates that the battery provided with this product shall not be treated as household waste. On certain batteries this symbol might be used in combination with a chemical substance symbol. The chemical symbols for mercury (Hg) or lead (Pb) are added if the battery contains more than 0.0005% mercury or 0.004% lead.

2.3 Information on the Disposal of the Packaging

- The packaging of the product is manufactured from recyclable materials.
- Dispose of by sorting in accordance with waste regulations.
- Do not dispose of along with normal household waste.

2.4 Information on Power Saving

- Those items mentioned below will help you reduce the consumption of natural resources as well as save your money by reducing electricity bills.
- Switch your TV set to stand-by if you will not use it for a while. In standby mode, the TV set uses a very little amount of energy (≤ 0.5 W).
- If you intend to not use the device for an extended period, unplug the power cord from the socket.
- If the device has a main switch, it will be enough to shut down the device via main switch. The device's energy consumption will reduce almost to Zero Watt.
- When you switch off or unplug the TV, the switch-on timer and the programmed recordings will not work.
- Select a location for storing the device where no direct sunlight falls on the screen. Thus, you can select a lower backlight and provide power saving.
- TV consumes less energy when brightness is reduced.

2.5 Information on PCB Conformity

- "Does not contain PCB (Polychlorinated Biphenyl)."

2.6 Information on Interface Requirements

- This product has been manufactured in compatibility with Telecommunication networks.

2.7 Information on Still Images

- Watching the same image for a long time on the screen may cause the still image to remain feebly on the background. Feeble image(s) on the background is/are originated from LCD/LED technology and does/do not require any action under guarantee. To avoid such cases and/or minimize the impact, you may observe the tips below.
- Do not allow the same TV channel to stay on the screen for a very long time. Channel logos may cause this situation.
- Do not allow the images, which are not full screen, to constantly stay on the screen; if not streamed in full screen format by the broadcaster, you can convert the images to full screen by changing picture formats.
- Higher brightness and/or contrast values will lead this impact to appear faster; therefore, you are recommended to watch your TV in the lowest brightness and contrast levels.

2.8 Information on Electromagnetic interference

- Devices connected to the product (satellite receiver, DVD player, and etc.) or signal emitting devices (router and etc.) close to the product may cause disturbance in the image and noise in the sound.
- Connection cables used on the product must be shorter than 3 m.
- If the product cannot perform its function due to electrostatic discharge, the user may need to switch off and then switch on the product.
- A shielded, HDMI-certified and ferrite-core cable shall be used with the product.
- If the product cannot be recovered as a result of an electrostatic discharge, user intervention will be required.

2.9 EU Directives

This product complies with 2014/53/EU, 2009/125/EC, 278/2009, 642/2009, 2017/1369/EU, 1062/2010, 2011/65/EU, 2019/2013/EU, 2019/2021/EU. directives:

To obtain a copy of declaration of compliance (DoC);

Please visit <https://www.arcelik.com.tr/destek/>. You can access the declaration of conformity by typing model number of your television indicated on the cover page of the instruction manual into the field where it says "Enter model number".



This appliance can be used observing the legal regulations in the European countries below. AT, BE, BG, CH, CY, CZ, DE, DK, EE, ES, FI, FR, GB, GR, HU, IE, IS, IT, LI, LT, LU, LV, MT, NL, NO, PL, PT, RO, SE, SI, SK, HR, TR
5150 -5350 MHz band can be used indoors only. (For Wi-Fi/Bluetooth integrated model or Wi-Fi integrated model). This device can also be operated in the countries outside Europe.

2.10 Note for Customers in Turkey

This device's WLAN (Wi-Fi) feature can only be used indoors. In Turkey, outdoor use is not allowed. Make sure WLAN (Wi-Fi) feature is closed when using outdoors.

2.11 Wireless LAN Module Specification

Frequency Range: Output power (Maximum)

2400 MHz - 2483.5 MHz: <20dBm

2.12 Wireless LAN Module Specification

Frequency Range: Output Power (Maximum)

5150 MHz - 5250 MHz: <23dBm

5250 MHz - 5350 MHz: <23dBm

5470 MHz - 5725 MHz: <23dBm

2.13 Bluetooth (*) Module Specification

Frequency Range: Output power (Maximum)

2400 MHz - 2483.5 MHz: <20dBm

(*) Optional, not available on all products.

2.14 Notes for WLAN Connection

Notes for customers:

The following information is only applicable for devices that are sold in countries enforcing EU regulations

For the customers in Italy;

Public use is subject to service provider's permission.

For the customers in Norway;

Radio equipment use is not allowed in a geographical area within 20 km diameter of Ny-Alesund, Svalbord.

For the customers in Russia;

Short Range Device Applications with FHSS Modulation.

Maximum 2.5 mW e. i. r. p.

for collecting telemetry information for automatic tracking and source calculation systems, 100mW e. i. r. p is the maximum allowed short range device density value permitted for use on outdoor applications without any limitation on installation height. For uses with other purposes, this applies to outdoor application in which this value does not exceed 10m above the ground.

Short range device density for indoor applications is 100mW e. i. r. p maximum.

Short range device applications with broadband modulation with DSSS and other than FHSS.

The maximum average density value for short range devices with broadband modulation with DSSS and other than FHSS is 2 mW/MHz or 100mW e. i. r. p.

For only the purpose of compiling telemetry data for automatic monitoring and source estimation systems, maximum short range device allowed to be used in outdoor applications is 20 mW/MHz or 100 mW e. i. r. p.

Maximum density value for indoor use of short range devices is 10mW/MHz or 100 mW e. i. r. p.

For the customers in Ukraine;

Maximum short range device density value for indoor uses, along with internal antenna with 6 dBi amplification factor

2.15 Information on the Symbols Which May Be Present on the Back Cover of the Appliance



Double insulation symbol

Indicates that this product doesn't require grounded connection.



Alternating current symbol

Indicates that the product operates with the mains voltage.



Direct current symbol

Indicates that this product operates with the AC/DC adapter supplied with the appliance

only

2.16 Service Information for Authorised Dealers

This product complies with the European Union directives and regulations specified below:

2014/53/EU Radio Equipment Directive

2009/125/EC: Directive and relevant for ecodesign for products using energy as well as its following sub-directives;

278/2009: Regulation regarding eco-friendly design requirements regarding energy consumption of uncharged external power sources and average active efficiency (for models with AC/DC adapters);
642/2009: Regulation regarding environmentally-conscious design requirements for TVs.

801/2013 Amending regulation regarding ecodesign requirements for televisions.

2010/30/EU: Directives regarding Energy Labelling of Energy-Related products as well as its following sub-directives;

1062/2010: Regulation regarding energy labelling of televisions.

2011/65/EU: Directive on limitations on use of certain hazardous materials on electric, electronic domestic and office equipment.

2.17 Information on Licenses



HIGH-DEFINITION MULTIMEDIA INTERFACE

- HDMI, the HDMI logo and High-Definition Multimedia Interface are trademarks or registered trademarks of HDMI Licensing LLC.
- Dolby, Dolby Vision, Dolby Audio and Double-D symbols are registered trademarks of Dolby Laboratories Licensing Corporation. Manufactured under license

of Dolby Laboratories. Confidential Unpublished Works. Copyright: © 1992-2024 Dolby Laboratories. All rights reserved.

- The availability of Google Assistant varies by region. Google, YouTube, Android TV, Chromecast built-in and other trademarks are trademarks of Google LLC.

2.18 Information on Software Updates

- The features, descriptions and pictures provided in the user manual may change with the update of TV software.

3 Your Product

3.1 Contents of the Package

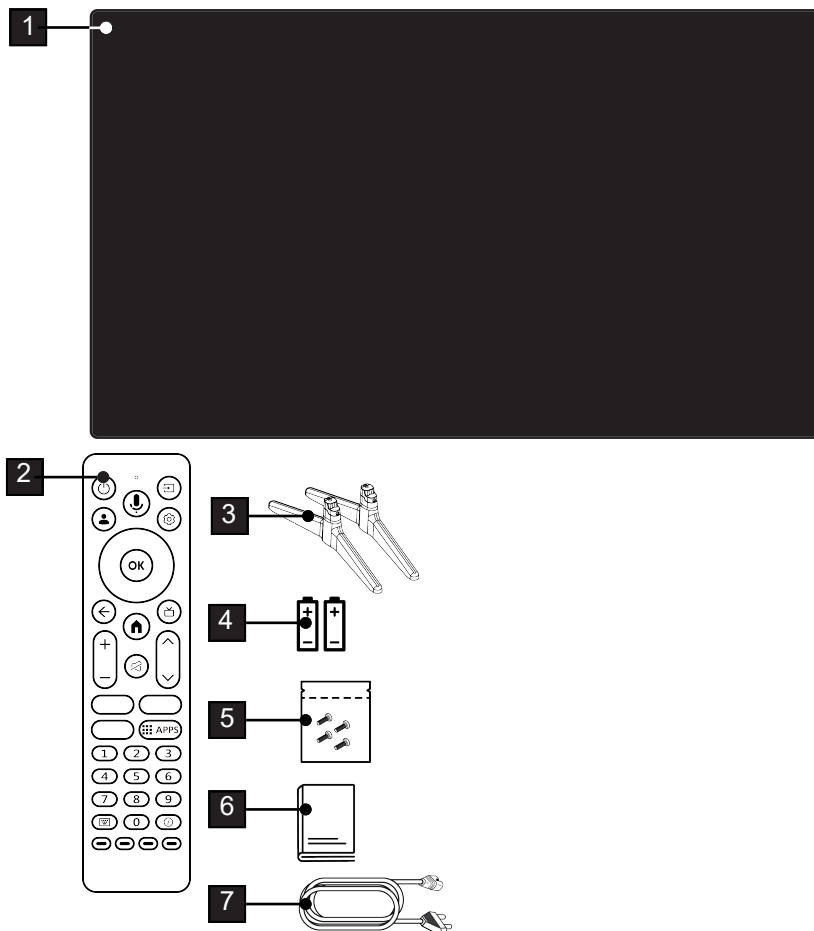

1 Television

3 Stand

5 Screws and installation instructions
for the stand

7 Power cord

2 Remote control

4 Batteries for remote control

6 Quick instruction manual

3.2 Installation or Hanging

Select a location so that no direct sunlight falls on the screen.

3.2.1 Installation with Stand

- To mount the stand, refer to the installation instructions included.
- Place the TV set on a hard, level surface.

3.2.2 Preparation for Installation with a VESA Installation Kit

Contact authorized dealer to purchase the installation kit.

You will need:

- A pair of scissors,
- A cross-tip screwdriver.



Follow the installation instructions for the VESA installation kit.

1. Place the TV in the film on a smooth surface with the screen facing down.
2. Cut open the film on the back side using the scissors.
3. Connect the required cables to the connectors on the TV. Refer to the "Connecting the antenna and the power cord" [▶ 19] section in this manual.
4. Tie the cables so they do not hang down onto the floor.
5. Screw the VESA installation kit onto the television and mount it according to its installation instructions.

3.3 Inserting Batteries into the Remote Control

1. Open the battery compartment.
2. Insert batteries as marked on the bottom of the battery compartment (2 × Micro/R03/AAA).
3. Close the battery compartment.

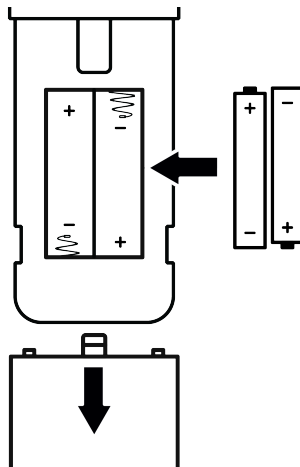

Notes:

- If the television no longer reacts properly to remote control commands, the batteries may be flat. Never keep flat batteries inside the battery compartment.
- The manufacturer accepts no liability for damage resulting from used batteries.
- Batteries, including those which contain no heavy metal, must not be disposed of with household waste. Please dispose of used batteries in an environmentally sound manner. Find out about the legal regulations which apply in your area.

3.4 Product Introduction

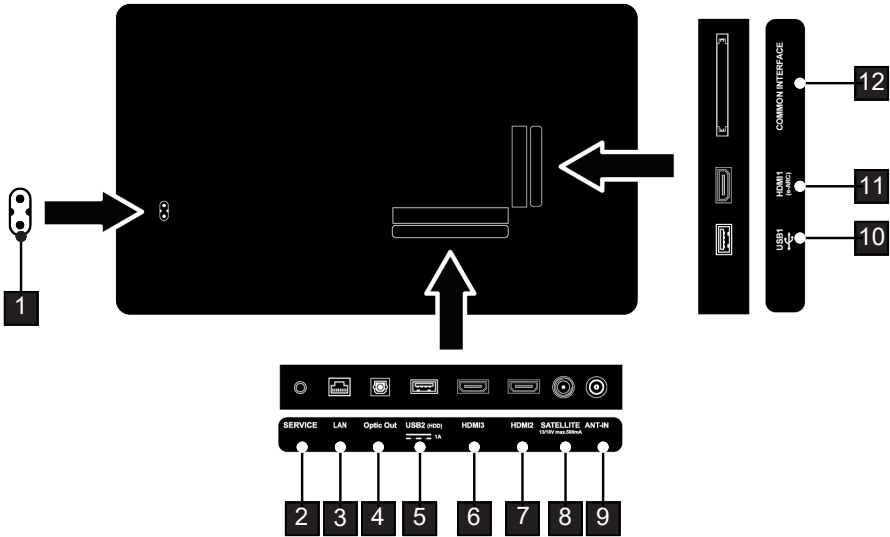

- 1 Power cable input.
- 2 Service only.
- 3 Network connection.
- 4 Optical audio output.
- 5 USB port for external data medium.
- 6 HDMI port for digital audio and image data.
- 7 HDMI port for digital audio and image data.
- 8 Satellite antenna socket. Suitable for single-cable SCR system.
- 9 Input for antenna cable (terrestrial antenna or cable connection).
- 10 USB port for data medium and keyboard.
- 11 HDMI port for digital audio and image data.
- 12 CA module slot for receiving encrypted channels.

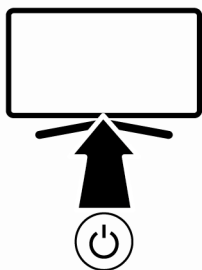

3.5 Keypad





3.5.1 Switching the Appliance On from the Standby Mode

1. Press the  to turn on the TV from the standby mode.

3.5.2 Switching and Restoring the Appliance to/from the Sleep Mode

1. The TV set switches to sleep mode when the  is pressed shortly while it is on.
2. The TV set switches on from the sleep mode when the  is pressed shortly while it is on the sleep mode.

3.5.3 Switching the Appliance to the Standby Mode

1. Press the  for 5 seconds to switch the appliance to the standby mode
⇒ Turn off menu will be displayed.
2. Select OK and confirm by pressing .
3. The TV set switches to the standby mode.

3.6 Connecting the Antenna and the Power Cord

3.6.1 DVB-S Satellite Antenna Connection

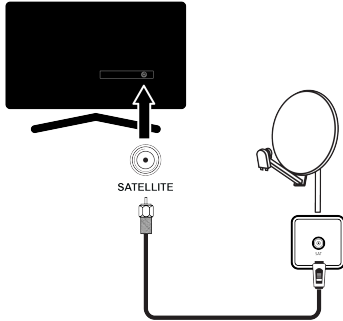

1. To receive digital satellite channels (DVB-S), connect the satellite antenna cable to the **SATELLITE** antenna socket on the TV set.

3.6.2 DVB- T, DVB- C and Analogue Antenna Connection

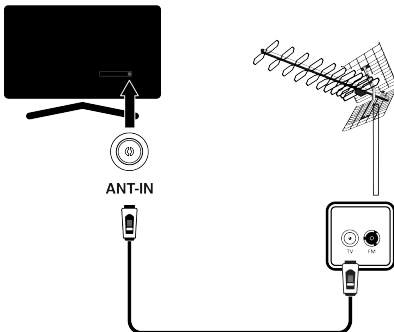

1. To receive terrestrial digital channels (DVB- T), Digital cable channels (DVB-C) or Analogue broadcast channels, connect the antenna cable to the **ANT IN** socket on the television set.

Note:

- When connecting an indoor antenna, you may have to try it out at different positions until you get the best reception.

3.6.3 Electrical Connection

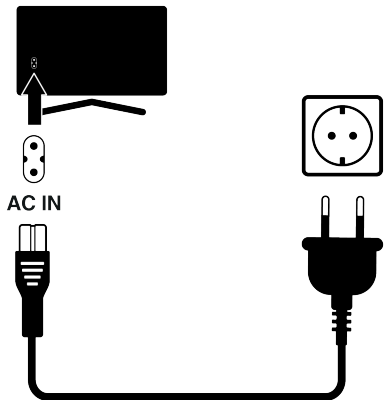

1. Plug the mains cable into the wall socket.



Only plug the device into the mains socket after you have connected the external devices and the antenna.

Do not use an adapter plug or extension cable which does not meet the applicable safety standards. Do not tamper with the power cord.

3.7 Remote Control

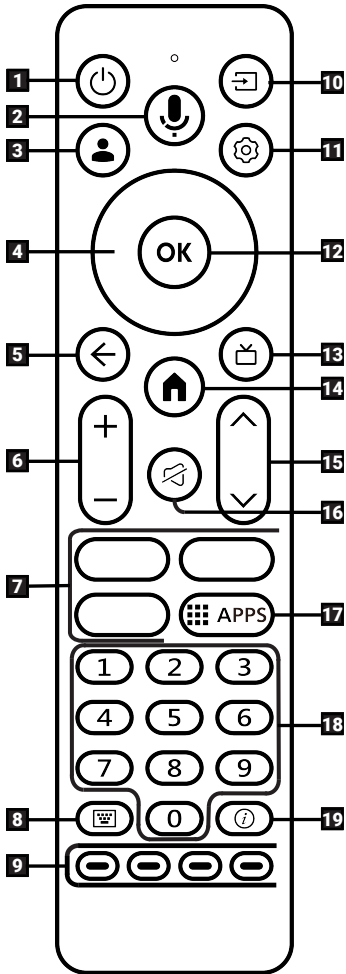

1. Turns the TV on/off (stand-by).
2. Voice Control.
3. Opens the Select Account menu.
4. Up/down, right/left direction buttons.
5. Switches the menus one level back.
6. Adjusts the volume.
7. Application shortcuts.
8. Opens the screen keyboard.
9. Selects/activates various functions in menus.
10. Selecting an input.
11. Opens menus of various functions.
12. Confirms/activates various functions.
13. Switches to the TV Mode, Opens the electronic TV Guide.
14. Opens the Home menu.
15. Selects the channels step by step.
16. Turns the sound on/off (Mute).
17. Opens Your Applications menu.
18. Directly selects the channels.
19. Displays information.

3.8 On-Screen Keyboard

1. Press  on the remote control.

⇒ The on-screen keyboard involving various function buttons will be displayed.

⇒ The function buttons on the on-screen keyboard are described below.

⇒ On-screen keyboard is only enabled in the live tv mode.

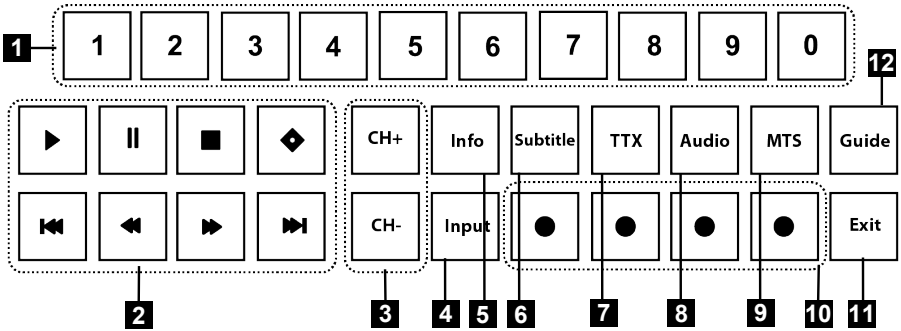

1. Directly selects the channels.
2. Record, Play, Stop, Forward, Reverse.
3. Selects the channels step by step.
4. Selecting an input.
5. Displays information.
6. Opens subtitle menu.
7. Switches between teletext and TV modes.
8. Selects the sound style.
9. Selects audio language.
10. Selects/activates various functions in menus.
11. Exits from the menu.
12. Opens the electronic TV Guide.

4 Settings

4.1 Preparation

The Television is fitted with an “installation assistant”, which guides you step by step through the basic settings.

Using the screen dialogue, the user can make supposedly complex settings and data entries simply and clearly for everybody.

Pages and dialogue items appear on the screen, which identify the subsequent and likely operating steps.

Settings for connecting to the home network

Depending on the connection type of the home network, connect your television to the home network:

- via a LAN connection or
- Wireless network connection with WLAN

Tuning television channels

Depending on the type of antenna connected, you can decide which channels you would like the television to search for.

DVB-S digital satellite channels

Sets the digital TV channels.

You have two options for this search:

Basic set-up that pre-sets a standard choice, e.g. Astra satellite 19.2° Eastern; you just need to start the scan; the professional installation, which allows you to make all required settings and set parameters for your receiver system.

DVB- C digital cable channels

Sets the digital cable TV channels.

DVB-T digital terrestrial channels

Sets the digital terrestrial TV channels.

Note:

See Detailed Channel Settings [► 91] section for more information on digital television channel settings.



4.2 Initial Set-up and Setting the TV set

1. Connect the antenna and external device cables.

2. Insert the power plug into the socket.

3. Switch on the TV set with the  on the remote control.



⇒ The remote control pairing menu will be displayed on the screen after a while.

4. In order to pair the Bluetooth remote control, press  and  simultaneously for 5 seconds.

⇒ The LED on the remote control starts to flash.

⇒ When remote control-TV pairing is completed, ✓ sign, and then **Welcome** menu will be displayed on the screen.

Important:

- If you have problems in pairing the Bluetooth remote control, you need to reset it. To do this, press and hold  and  on the remote control simultaneously for 5 seconds.

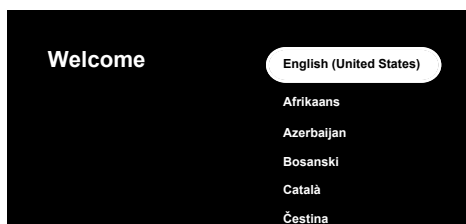

5. Select language.

6. Select country.

⇒ **Select the TV Mode** menu will be displayed.

7. Select **Home** or **Store** and press the .

⇒ **Home mode:** This option is optimized to provide energy efficiency when the TV set is used in a household.

⇒ **Store mode:** This option is optimized to allow demo display on a store with fixed settings.

⇒ Wireless network connection menu will be displayed.

Note:

- In case you do not have Internet connection, select **Skip** at the bottom of Wireless network connection menu and press **OK**. Without a network connection, only the setup where only antenna broadcast and external device connections are active is carried out.
8. Select your wireless network with the ▲/▼ and press **OK**.
 9. Enter the wireless network password with the screen keyboard, select ✓ and press the **OK**.
 - ⇒ After the **Connecting to network** message, the **Connected** message will be displayed.
 - ⇒ **Sign in** menu will be displayed.
 10. Enter the e-mail address with the screen keyboard.
 - ⇒ Select → on the display and press **OK**.
 11. Enter the password for the account with the screen keyboard.
 - ⇒ Select → on the display and press the **OK**.
 12. If you are using two-step verification, follow the instructions displayed on your TV and on the screen of your phone.
 - ⇒ **Terms of Service** will be displayed.
 13. Select **Accept** option, and press the **OK**.
 14. Select **Agree** option, and press the **OK**.
 - ⇒ **Google Services** will be displayed.
 15. Select **Agree** option, and press the **OK**.
 16. To perform a search in all supported TV applications, select the **Allow** option and press **OK**, or select the **No** option and press **OK**.
 - ⇒ **Voice Match** menu will be displayed.
 17. To allow **Voice Match**, select **Agree** and press the **OK** or select **No, thanks** and press the **OK**.
 - ⇒ **Personal results** menu will be displayed.
 18. To allow **Personal results**, select **On** and press the **OK** or select **No, thanks** and press the **OK**.
 - ⇒ **Select Home** menu will be displayed.
 19. To add your TV to Google Home and control it with other nearby devices with Google Assistant feature, select **Home** and press **OK**.
 20. To specify the location of TV, select a room and press **OK**.
 21. Select the subscribed applications you want to install from the list of the recommended applications and select the **Confirm** option and press **OK**.
 - ⇒ **Select Energy Mode** menu will be displayed.
 22. Select the energy mode, select **Low, Optimized** or **Increased** and press **OK**.
 - ⇒ **Network Privacy Policy** menu will be displayed.
 23. Select **OK** option, and press the **OK**.
 24. Select the antenna type.
 - ⇒ The next procedure depends on the selected antenna type. Continue with **Searching for Satellite Channels**, **Searching for Cable Channels** or **Searching for Terrestrial Channels** as per the antenna type you have selected.
 - ⇒ To continue without searching for channels, select **Next** and press **OK**.
- ### Searching for Satellite Channels
25. Select **Satellite**.
 - ⇒ **Satellite Antenna Type** menu will be displayed.

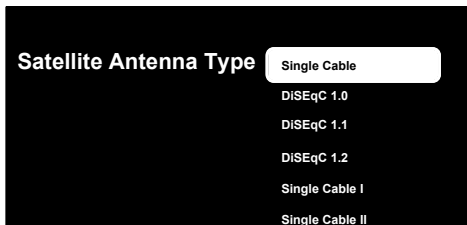

26. Select **Single Cable** and press the **OK**.

⇒ **Select Channel List** menu will be displayed.

Note:

- As per the satellite system used, select **DiSEqC 1.0, DiSEqC 1.1, DiSEqC 1.2, Single Cable I, Single Cable II or Tone Burst.**

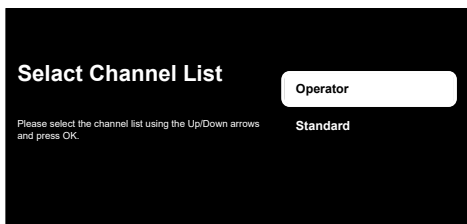

27. Select **Standard** or **Operator** and press the **OK**.

⇒ **Satellite Selection** menu will be displayed.

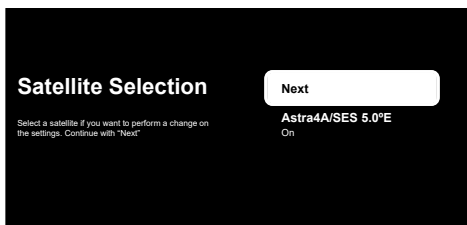

28. Select the satellite displayed on the list and press the **OK**.

⇒ **Satellite Settings** menu will be displayed.

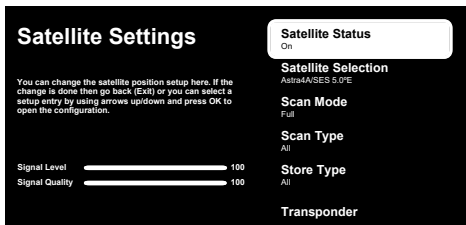

Note:

- When operator is selected, satellite settings are automatically received. In this case, it is not possible to make changes.

29. Select the **Satellite Status** option, and use the **OK** to select **On**.

30. Select **Satellite Selection** option, and press the **OK**.

⇒ **Satellite Selection** menu will be displayed.

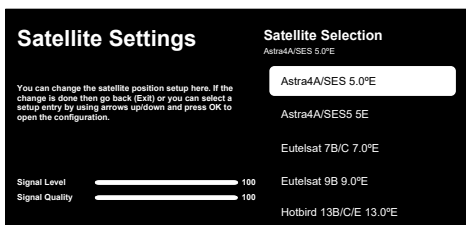

31. Select the satellite you want to scan for from the list and press the **OK**.

32. Select **Scan Mode** option, and press the **OK**.

⇒ **Scan Mode** menu will be displayed.

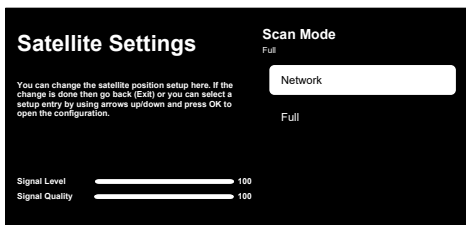

33. Select **Network** or **Full** and press the **OK**.

34. Select **Scan Type** and press the **OK**.

⇒ **Scan Type** menu will be displayed.

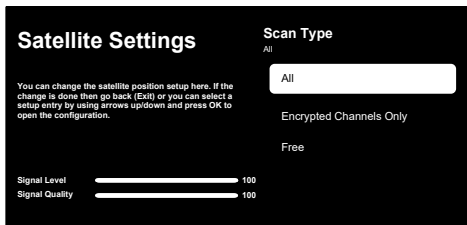

35. Select **Scan Type**.

- ⇒ Select **Free** for unencrypted channels only;
- ⇒ Select **Encrypted Channels Only** for encrypted channels only;
- ⇒ Select **All** for all satellite channels.

36. Select **Store Type**.

- ⇒ **Store Type** menu will be displayed.

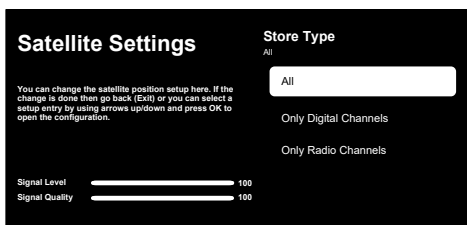

37. Select **Store Type**.

- ⇒ Select **Only Digital Channels** for TV channels only;
- ⇒ Select **Only Radio Channels** for radio channels only;
- ⇒ Select **All** for scanning both options.

Important:

- If you encounter a significant shortage of channels or no signal, make sure that the cable connection, signal level, Diseqc A/B/C/D and LNB selections are made correctly.

38. Press the **←** to return to the previous menu after completing the settings.

39. Select **Next** option and press the **OK**.

- ⇒ **Channel Scan** menu will be displayed.

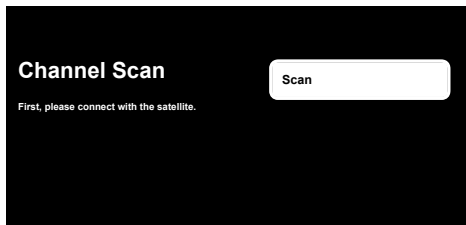

40. Select **Scan** option, and press the **OK**.

- ⇒ **Scanning** menu will be displayed and the scan for TV stations shall start.

41. When scanning is completed, you can select another broadcast source and continue scanning channels, or complete the scan and continue by selecting **Next** and pressing **OK**.

- ⇒ The scan is complete when the **FINISH** message is displayed.

42. Press **OK** to complete the set-up.

- ⇒ **Smart TV Terms of Service** will be displayed.

43. Select **Agree** option, and press the **OK**.

44. **Loading your applications** menu, and then **Get the most out of your Google TV** menu will be displayed.

45. To complete the setup, select **Google Photos as screensaver**, **Multiple profiles**, **Kids features** and/or select **Go to Google TV** and press **OK**.

Searching for Cable Channels

46. Select **Cable**.

- ⇒ **Channel Scan** menu will be displayed.

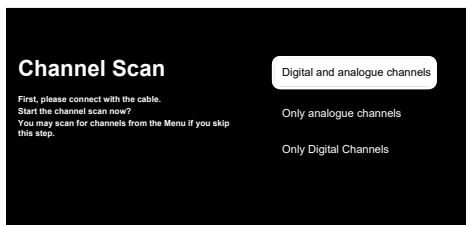

47. To start scanning for channels, make your selection and press the **OK**.

⇒ **Cable Scan Configure** menu will be displayed.

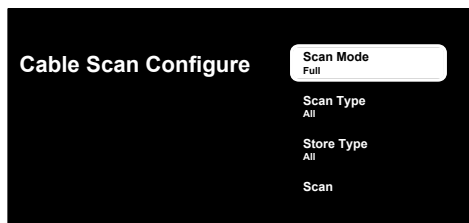

48. Select **Scan Mode**, **Scan Type** and **Store Type**.

49. To start scanning for channels, select **Scan** and press the **OK**.

⇒ **Scanning** menu will be displayed and the scan for TV stations shall start.

50. When scanning is completed, you can select another broadcast source and continue scanning channels, or complete the scan and continue by selecting **Next** and pressing the **OK**.

⇒ The scan is complete when the **FINISH** message is displayed.

51. Press the **OK** to complete the set-up.

⇒ **Smart TV Terms of Service** will be displayed.

52. Select **Agree** option, and press the **OK**.

⇒ **Loading your applications** menu, and then **Get the most out of your Google TV** menu will be displayed.

53. To complete the setup, select **Google Photos as screensaver**, **Multiple profiles**, **Kids features** and/or select **Go to Google TV** and press the **OK**.

Searching for Terrestrial Channels

54. Select **Antenna**.

⇒ **Antenna Setup** menu will be displayed.

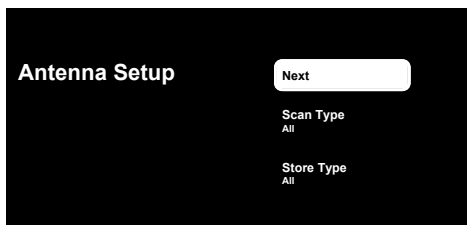

55. Select **Scan Type** and **Store Type**.

56. Select **Next** and press the **OK**.

⇒ **Channel Scan** menu will be displayed.

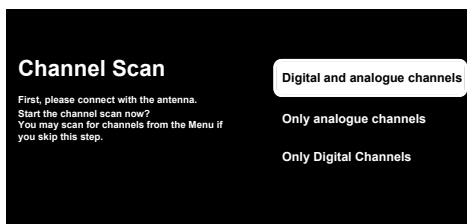

57. To start scanning for channels, make your scanning selection and press the **OK**.

⇒ **Scanning** menu will be displayed and the scan for TV stations shall start.

58. When scanning is completed, you can select another broadcast source and continue scanning channels, or complete the scan and continue by selecting **Next** and pressing the **OK**.

⇒ The scan is complete when the **FINISH** message is displayed.

59. Press the **OK** to complete the set-up.

⇒ **Smart TV Terms of Service** will be displayed.

60. Select **Agree** option, and press the **OK**.

61. **Loading your applications** menu, and then **Get the most out of your Google TV** menu will be displayed.

62. To complete the setup, select **Google Photos as screensaver**, **Multiple profiles**, **Kids features** and/or select **Go to Google TV** and press the **OK**.



4.3 Editing Digital Channels

Channels found at the end of the scan are stored separately for each tuner mode.

You can change the order of channels, skip channels, rename channels and delete the channel list via the channel management. You can also create and edit your favorites list.

You can edit the television channels from the **Channels** menu, or you can easily edit the channels with the **Channel Editor** application built into your television.

4.3.1 Starting Channel Editor Application

1. Press .
 2. From the **Your apps** tab, select **Channel Editor** application and press the .
- ⇒ **Channel Editor** menu will be displayed.

Notes:

- Additional operations are explained in the following sections.

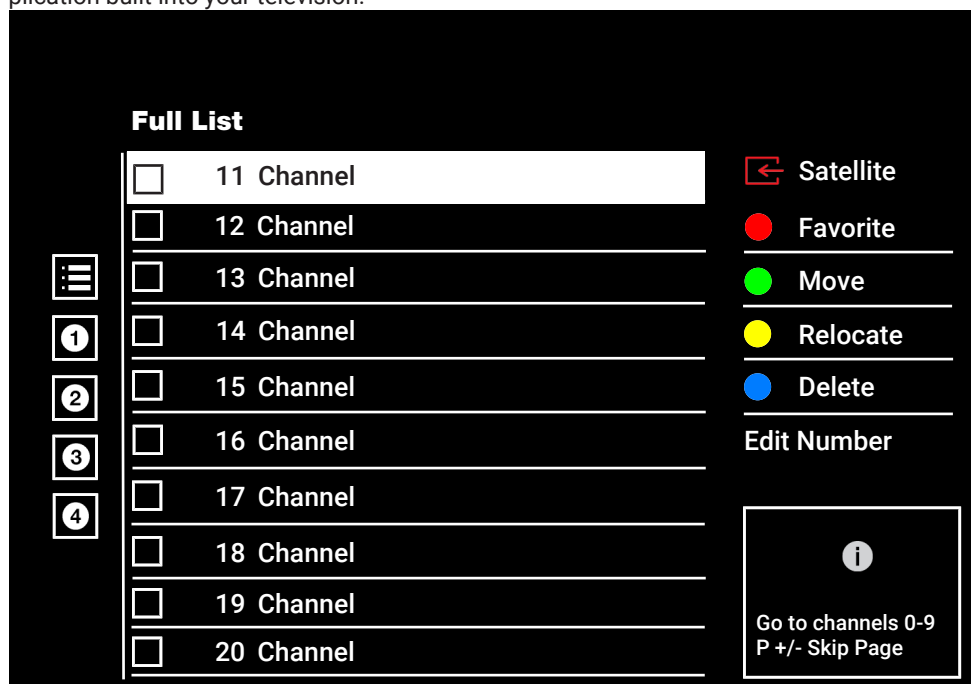

4.3.2 Tuner Mode Selection

The channel table for all sources as satellite (Standard), satellite (Operator), cable and antenna is stored separately. To edit, first select the broadcast source you will edit.

1. From the **Channel Editor** menu, select **Source** and press the .

2. Select **Satellite**, **Cable** or **Antenna** and press the .
- ⇒ The channel list is displayed based on your choice of channel.

4.3.3 Creating a Favourite List

You can save your favorite channels as a list.

Notes:

- Favorite lists must be created separately for all sources (satellite, cable and air).

- You can save your favorite channels in 4 separate lists.
- Before adding channels to the favourite list, you shall select the favourite list to add the channel.

1. In the **Channel Editor** menu, select the channel(s) you want to add to the favorite list, and then put a check with the **OK**.
2. Press the **OK** (red) to select the favourite list.
3. Select favourite list you want to add channels with **OK** (red), **OK** (green), **OK** (yellow) or **OK** (blue) (FAV 1 to FAV 4).
4. To exit the **Channel Editor** menu, select **OK** and then select **Yes** and press the **OK**.

4.3.4 Moving A Channel in the Favourites List

Change the location of the channels reciprocally in favourites list. For example; move channel 2 to channel 20, channel 20 to channel 2.

1. In the **Channel Editor** menu, select the favourite list to which you want to add the channel and press the **OK**.
 - ⇒ Selected favourites list channels are displayed.
2. Select the first channel you want to move reciprocally and put a check with the **OK**.
3. Press **OK** (yellow).
4. Select the second channel you want to move and press the **OK**.
 - ⇒ The positions of two channels are now changed reciprocally.
5. To exit the **Channel Editor** menu, select **OK** and then select **Yes** and press the **OK**.

4.3.5 Deleting Channels in the Favourites List

1. In the **Channel Editor** menu, select the favourite list to which you want to add the channel and press the **OK**.
 - ⇒ Selected favourites list channels are displayed.
2. Select the channel(s) you want to delete and then put a check with the **OK**.
3. Press the **OK** (blue) to delete the selected channels.
 - ⇒ Channel(s) are deleted from the selected favorite list.
4. To exit the **Channel Editor** menu, select **OK** and then select **Yes** and press the **OK**.

4.3.6 Move Channel

Move the channels to the channel location you want and edit the list.

1. In the **Channel Editor** menu, select the channel(s) you want to move and then put a check with the **OK**.
 - ⇒ The channel(s) will be marked with ✓.
2. Press the **OK** (green).
3. Select the new position of the channel and press the **OK**.
 - ⇒ Channel(s) now are moved to the new channel position.
4. To exit the **Channel Editor** menu, select **OK** and then select **Yes** and press the **OK**.

Note:

- If you change the channel order, the channel numbers sent by the broadcaster will change.

4.3.7 Changing Channel Location

Change the location of the channels reciprocally. For example; move channel 2 to channel 20, and channel 20 to channel 2.

1. In the **Channel Editor** menu, select the first channel you want to move reciprocally and put a check with the **OK**.
2. Press **OK** (yellow).
3. Select the second channel you want to move and press the **OK**.
 - ⇒ The positions of two channels are now changed reciprocally.
4. To exit the **Channel Editor** menu, select **←** and then select **Yes** and press the **OK**.

4.3.8 Deleting a Channel

1. In the **Channel Editor** menu, select the channel(s) you want to delete and then put a check with the **OK**.
2. Press the **OK** (blue) to delete the selected channels.
 - ⇒ Channel(s) are deleted.
3. To exit the Channel Editor menu, select **←** and then select **Yes** and press the **OK**.

4.3.9 Deleting a Channel List

Delete the channel list of the selected broadcast source.

1. To switch to TV mode from Home menu, press **TV**.
2. Press **OK** and use **▲**, and then **▶** to select **Channel Management** and press **OK**.
 - ⇒ **Channel Management** menu will be displayed.
3. Select **Delete Channel List** and press the **OK**.
4. Select **Continue** to confirm the deletion or select **Cancel** to cancel it, and press the **OK**.
5. Press the **←** to return to the previous menu or **Home** to return to Home menu.

4.3.10 Edit Channel

Rename channels.

1. To switch to TV mode from Home menu, press **TV**.
2. Press **OK** and use the **OK** (red) to select **Channel Management**.
 - ⇒ **Channel Management** menu will be displayed.
3. Select **Edit Channel** and press the **OK**.
4. Select the channel you want to edit and press the **OK**.
 - ⇒ **Channel Information** will be displayed.
5. Select **Channel Name** and press the **OK**.
6. To delete the current name, use **◀/▶/▲/▼** to select the **✕** key and press the **OK**.
7. Select the character/number with the **◀/▶/▲/▼** and move to the next character with the **OK**, repeat the same procedure for all characters/numbers.
8. To save the new name, select the **→** from the screen keyboard and press the **OK**.
9. Press the **←** to return to the previous menu or **Home** to return to Home menu.

4.3.11 Skip Channel

With the **▲/▼** or , you can select the TV channels you want to skip during channel selection. It is possible to select channels that are skipped with the number buttons.

1. Press **OK** and use the **OK** (red) to select **Channel Management**.
 - ⇒ **Channel Management** menu will be displayed.
2. Select **Skip Channel** option, and press the **OK**.
 - ⇒ **Skip Channel** menu will be displayed.

- From the channel list, select the channel(s) you want to skip and then put a check with the **OK**.

Note:

- Press the **⏮** (red) to display the previous page in the skip channel menu, and press the **⏭** (green) to view the next page.
- Press the **⏪** to return to the previous menu or **⏴** to return to Home menu.

4.4 Picture Settings

- Press the **⏴** and then the **⚙️**.
- Select **⚙️ Settings** with **OK**.
- Select **Display & Sound** option, and press **OK**.
- Select **Picture** option, and press the **OK**.
⇒ **Picture** menu will be displayed.

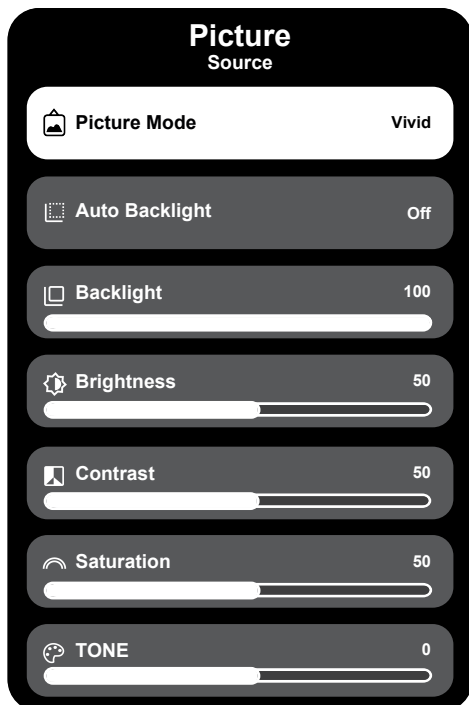

- Select the line/function with **▲/▼**, and select the value/option with **◀** or **▶**.

Note:

- Other settings are available under the **Advanced settings**.
- Select **Advanced settings** option, and press the **OK**.
 - Select the line/function with **▲/▼**, and select the value/option with **◀** or **▶**.
 - Press **⏪** to return to the previous menu or press **⏴** to return to Home menu.

4.4.1 Advanced Settings

The “advanced settings” are in principal digital image improvements however, these should be only used when necessary, when picture quality and transmission is excellent. They may improve the display with poor material, as well, but may adversely affect the display where transmission and picture quality are excellent.

Colour Temperature: - Colour temperature determines the tone of the pictures; lower colour temperatures make the white tints look in blue tones, while higher colour temperatures make them look in yellow tones. This setting helps you obtain the best picture quality according to your environment and personal choice.

Digital Noise Reduction (DNR): – This function can only be selected with digital reception sources and AV presets. It reduces any interference from artefacts (pixel blocks) from digital programmes due to MPEG compression (such as from DVB-T receivers and lower transmission rates or DVD players).

Noise Reduction (MPEG NR): – Reduces the "noise" areas by displaying the picture a bit sharper and creating a slight blur. Thus, it must be used as little as possible with good picture material.

Dynamic Contrast: – This function dynamically and optimally adjusts the contrast for the respective picture content by analysing images and then altering this depending on a change in contrast. This increase in the contrast however, may also reduce the visible brightness levels in the picture.

Micro Dimming: – Increases the level of details in dark pictures. The television divides the screen into small sections and analyses each section individually to determine the best brightness value. This ensures that more detailed pictures are obtained in dark contents.

Dynamic Colour Booster: - Dynamic Colour Booster analyses the colours on your TV screen, and adjusts the colour saturation specific to each scene.

Movie Maker Mode: – This function is automatically activated when a movie is detected. It closes the PQ blocks and displays the movie with the picture settings set by the cinematographer of the movie. The same colour temperature “Temperature”, brightness is set to 200 nits for a movie theatre experience.

Skin Colour: – This function provides the most accurate skin colour by adjusting the brightness and saturation specific to the skin colour.

Film mode: detects and processes feature films automatically for all channel sources. This means you will always receive an optimal picture. This functions in the modes 480i, 576i and 1080i in TV playback and for other channel sources. If the Film mode is switched on for programmes without a feature film signal, minor problems such as picture freeze, defective subtitles or fine lines in the picture could occur.

Blue intensity: – This function increases the blue intensity of white and grey tones and enhances the brightness perception.

Gamma: – This setting establishes which brightness value should be displayed for which digital transmission value. Most recordings are transmitted with a gamma value of 2.2 (all Windows PCs and newer PCs with a MAC operating system work with this; older MAC systems and transmissions without a colour profile mostly operate with a gamma value of 1.8).

Game Mode: – When this function is activated, the video delay is minimized (under 33 ms) and the video delays that may be encountered while playing games is prevented, creating a better gaming experience.

Computer Mode: – This function disables all advanced picture settings and displays the image as if it is watched through a monitor.

MEMC: – Motion stabilization eliminates judder effects in motion content, providing a smoother viewing experience.

HDMI RGB interval: – This function sets the white - black interval of the TV according to the correct values depending on the device connected through the HDMI.

Colour area: – This function selects the colour area and displays the colours in the standard or wide scale.



Low blue light: – This function reduces the amount of blue light emitted from the LEDs, allowing more natural light to be emitted from the TV screen and reducing eye strain.

Colour Management System: – This function allows the brightness, contrast and tone of the colours to be adjusted separately. It is possible to adjust these settings separately for red, green, blue, magenta, black and yellow colours. With this function, advanced settings can be made in very specific contents.





11-Point White Balance Correction: – This function provides precise colour temperature adjustment in different shades of grey. When content containing shades of grey is played on the screen, the red-green-blue components of the grey tones can be precisely adjusted separately with this function.

4.4.2 Restoring Factory Defaults for Picture Settings

1. Select **Reset to Default** from the picture menu and confirm with the **OK**.
2. Select **OK** to confirm the reset or select **Cancel** to cancel it, and press the **OK**.





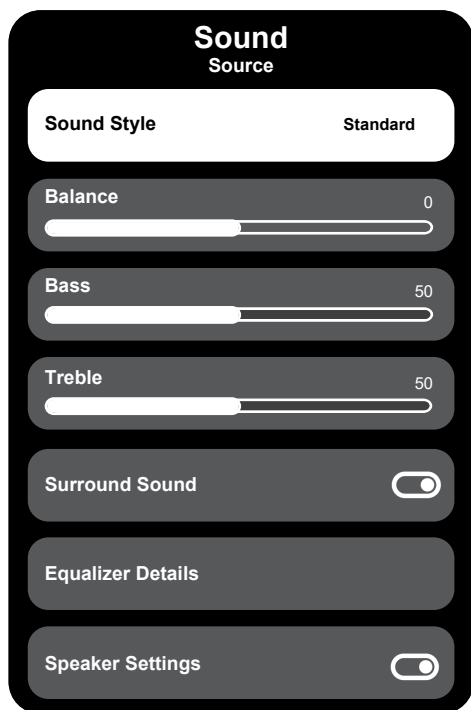

3. Press the  to return to the previous menu or  to return to Home menu.

4.5 Sound Settings





1. Press .
2. Select  **Settings** and press the .
3. Select **Display & Sound** option  and press.
4. Select **Sound** option, and press the .
⇒ **Sound** menu will be displayed.







4.5.1 Sound Style

1. Select **Sound Style** from the sound menu and press the .
2. Select sound style with / and press the .
3. Press the  to return to the previous menu or  to return to Home menu.





4.5.2 Balance

1. Select **Balance** from the sound menu.
⇒ Adjust the volume with  or .
2. Press the  to return to the previous menu or  to return to Home menu.



4.5.3 Bass

1. Select **Bass** from the sound menu.
⇒ Adjust the volume with  or .
2. Press the  to return to the previous menu or  to return to Home menu.

4.5.4 Treble

1. Select **Treble** from the sound menu.
⇒ Adjust the volume with  or .
2. Press the  to return to the previous menu or  to return to Home menu.



4.5.5 Surround Sound



1. From the sound menu, select **Surround Sound** and use  to select **On** or **Off**.
2. Press the  to return to the previous menu or  to return to Home menu.

4.5.6 Equalizer

Equalizer offers a sound setting that you can create.



Note:

- It is active in the menu when **Equalizer Details**' **Sound Style**, **User** are selected.
1. Select **Equalizer Details** from the sound menu and confirm with the .
 - ⇒ **Equalizer Details** menu will be displayed.
 2. **120Hz** frequency band is active.
⇒ Press the  or  to set the preferred value.
 3. Select the next frequency band and repeat the adjustment procedure.

4. Press the  to return to the previous menu or  to return to Home menu.

4.5.7 Speaker Settings



You can turn off and on the internal speakers of TV.

1. From the sound menu, select **Speaker Settings** and press  to turn off/on the internal speakers.
2. Press the  to return to the previous menu or  to return to Home menu.





4.5.8 Speaker Delay

1. Select **Speaker Delay** from the sound menu.

⇒ Adjust the volume with  or .



2. Press the  to return to the previous menu or  to return to Home menu.

4.5.9 eARC

1. Select **eARC** from the sound menu and press the .
2. Select **Auto** or **Off** and press the .
3. Press the  to return to the previous menu or  to return to Home menu.

4.5.10 Automatic Volume



Television channels broadcast at different volumes. Automatic Volume Control function ensures the volume is kept at the same level when you switch between channels.

1. From the sound menu, select **Auto Volume Control** and use  to select **On** or **Off**.
2. Press the  to return to the previous menu or  to return to Home menu.





4.5.11 Downmix Mode

1. Select **Downmix Mode** from the sound menu and press the .





2. Select **Stereo** or **Surround** and confirm with the .

3. Press the  to return to the previous menu or  to return to Home menu.

4.5.12 Dialogue Enhancer



1. Select **Dialog Enhancer** from the sound menu and press the .
2. Select **Off**, **Low**, **Medium** or **High** and confirm with .
3. Press the  to return to the previous menu or  to return to Home menu.

4.5.13 Restoring Factory Defaults for Sound Settings

1. Select to reset the changes to the **Sound** menu **Reset to Default** and press the .
2. Select **Yes** to confirm the reset or select **No** to cancel it, and press the .
3. Press  to return to the previous menu or press  to return to Home menu.



5 Basic Functions for the Operation of the TV set

5.1 Switching on and off

1. Press the  to turn on the TV from the standby mode.
2. Press the  to switch the TV set to the standby mode.









5.2 Selecting the TV Mode

You can select the TV mode with three different methods.

1. Press the  on the Home screen.
⇒ TV Mode will be displayed on the last selected antenna source.
2. Press  select antenna type and press .
⇒ TV Mode will be displayed on the last selected antenna source.



5.3 Selecting the Signal Source and Antenna Type



You may perform the selection with three different methods.

1. Press the  select the signal source or antenna type and press the .
2. Press the  in the TV mode, confirm the **Source** option with the , select the signal source or antenna type and press the .
3. From **Home** menu, select  **Inputs** and press . Select the signal source or antenna type and press the .



5.4 Selecting Channels

You may perform the selection with three different methods.

1. Press the  to select channels directly.
2. Press the ,  to select channels step by step.

3. Press the  in the TV mode, select the channel from the **Channel List - All Channels** menu and press the .

5.5 Selecting Favourites List

1. Press  in the TV mode.
⇒ **Channel List - All Channels** will be displayed.
2. Press  (yellow).
⇒ **Filter Channels** menu will be displayed.
3. Select the favourites list and press .
⇒ The channels in the selected favourites list will be displayed.

5.6 Setting the Volume

1. Adjust the volume with the , .

5.7 Muting

1. Press .

5.8 Eco Mode Settings

Eco mode allows you to use the most efficient settings in terms of energy saving.

1. From the **Home** menu **Your apps** tab, select **Eco Mode** application and press the .
2. **Eco Mode** menu will be displayed.

5.8.1 Eco Mode

1. From **Eco Mode** menu, to enable **Eco Mode**, press .

Notes:



- When **Eco Mode** is enabled, **Picture Mode** will be automatically selected as **Energy Saving**.
- When **Picture Mode** is changed, **Eco Mode** will be closed.

5.8.2 Picture Mode

1. From the **Eco Mode** menu, select **Picture Mode** and press the .

2. Select the picture mode and press the .

5.8.3 Backlight

1. From the **Eco Mode** menu, select **Backlight** setting.
2. Use / to adjust **Backlight** intensity.

5.8.4 Smart Backlight

1. From the **Eco Mode** menu, to select **Smart Backlight** setting and select **On** or **Off**, press .

5.9 Changing the Picture Format

You can select one of the following picture formats.

Auto format

The picture format is automatically switched to 16: 9 for 16: 9 programmes.

The picture format is automatically switched to 4: 3 for 4: 3 programmes.

Full Screen format

When this mode is selected, the high resolution picture from the HDMI and Component inputs is not cropped and it is displayed in its original size. This mode is only enabled in the HDMI mode and for resolutions at or above 720p.

Super Zoom format

This setting is suited to films with a large width/height ratio.

Unscaled format

Unscaled format displays pictures in their original size.





4: 3 format

The picture is shown in 4: 3 format.

Widescreen movie 14:9 and Widescreen movie 16:9 formats

During programmes in 4: 3 format, the picture is stretched horizontally if 16: 9 or 14: 9 is selected.



With actual 16: 9 signal sources (from a satellite receiver or the Euro-AV socket) the picture fills the screen completely and with the correct geometry.

1. Press  in the TV mode.
2. Select **Screen** option, and press the .
3. Select the picture mode and press the .
4. Press the  to return to the previous menu or  to return to Home menu.



5.10 Parental Controls

There are movies which contain contents or scenes which are not suitable for children.

Certain programmes contain information which identifies these contents or scenes and have been given an access level from 4 to 18. You can select one of the access levels and thus authorise the playback.

1. Press  in the TV mode.
 2. Select **Parental Controls** option and press the .
- ⇒ **Enter your PIN code** message will be displayed.

Notes:

- PIN code is the four digit number that was specified at the end of the initial installation.
 - If you have not specified a PIN code at the end of the initial installation, you will need to specify it when you first enter the Parent controls. You can specify the PIN code by following the instructions on the screen.
3. Enter the PIN code using the  ...  or as described in the instructions on screen.
- ⇒ **Parental Controls** menu will be displayed.

Parental Controls

Blocked Channels

N/A

Programme Restrictions

Inputs Blocked

Note:

- Additional operations are explained in the following sections.

5.10.1 Blocking a TV Channel

Block individual television channels which are not suitable for children using a personal PIN code.

1. From the **Parental Controls** menu, select **Blocked Channels** and press the **OK**.
2. Select the channel you want to block and press the **OK**.
3. Press **←** to return to the previous menu or press **⬆** to return to Home menu.

5.10.2 Watching a Blocked TV Channel

To watch a TV channel blocked with PIN code, select the blocked TV channel and enter the PIN code.

1. Select the blocked channel with **1**...**0** or .
 2. Enter the PIN code on the displayed password screen using the **1**...**0**.
- ⇒ Blocked channel will be viewed.

Note:

- Channel will be blocked again when you change the channel.

5.10.3 Programme Restrictions

There are movies which contain contents or scenes which are not suitable for children.

Certain programmes contain information which identifies these contents or scenes and have been given an access level from 4 to 18. You can select one of the access levels and thus authorise the playback.

1. From the **Parental Controls** menu, select **Programme Restrictions** and press the **OK**.
2. Select **Rating Systems** option and press the **OK**.
3. Select the rating system with the **OK**.
4. Press the **←** to return to the previous menu.
5. Select **Ratings** option, and press the **OK**.
6. Select the access level and press the **OK**.
7. Press **←** to return to the previous menu or press **⬆** to return to Home menu.









5.10.4 Blocking an External Source

Block external sources individually by using your personal PIN code.

1. From the **Parental Controls** menu, select **Inputs Blocked** and press the **OK**.
2. Select the source you want to block and press the **OK**.
3. Press **←** to return to the previous menu or press **⬆** to return to Home menu.

5.10.5 Watching a Blocked External Source

To watch an external source blocked with PIN code, select the blocked TV channel and enter the PIN code.



1. To switch to TV mode from Home menu, press .
 2. Press the , select **Source** and press the , or press the , select the signal source with the / and press the .
 3. Enter the PIN code on the displayed password screen using the ....
- ⇒ Blocked source will be displayed.

Note:

- Source will be blocked again when you change the source.

6 Advanced Functions for the Operation of the TV set

You can adjust the advanced settings of the TV set in the Advanced Options menu.

1. Press  in the TV mode.
2. Select **Advanced Options** option, and press the .
⇒ **Advanced Options** menu will be displayed.

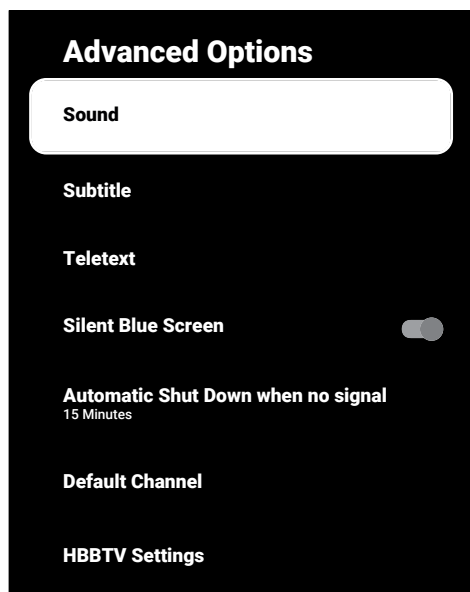



Note:





- Additional operations are explained in the following sections.

6.1 Changing the Audio Language

(only for digital television channels)



You can define a primary and a secondary audio language.

1. From the **Advanced Options** menu, select **Sound** and press the .
2. Select **Audio Language** and press the .
3. Select the audio language and press the .





4. Select **Second Audio Language** and press the .
5. Select the secondary audio language and press the .
6. Press the  to return to the previous menu or  to return to Home menu.

6.2 Audio Language

You can select various languages when watching digital channels. This depends on the programme being broadcast.





1. From the **Advanced Options** menu, select **Sound** and press the .
2. Select **Audio Language** and press the .
3. Select the supported audio language and press the .

Note:

- In the TV mode, press the  on the remote controller. From the on-screen keyboard, select  and press the  to change **Audio Language**.
4. Press the  to return to the previous menu or  to return to Home menu.

6.3 Audio File Type

You can select various languages when watching digital channels. This depends on the programme being broadcast.

1. From the **Advanced Options** menu, select **Sound** and press the .
2. Select **Audio File Type** and press the .
3. Select **Normal, Audio Description, Audio Subtitle, Hearing Impaired or Audio Description and Spoken Subtitle** and press the .
4. Press the  to return to the previous menu or  to return to Home menu.

6.4 Visually impaired

Note:

- Visually Impaired option is activated in the menu when **Audio File Type**, **Audio Description** is selected.
1. From the **Advanced Options** menu, select **Sound** and press the **OK**.
 2. Select **Audio File Type** and press the **OK**.
 3. Select **Audio Description** option, and press the **OK**.
⇒ **Visually impaired seçeneği etkindir.**
 4. Select **Visually impaired** and press the **OK**.
⇒ **Visually impaired** menu will be displayed.
 5. Select the desired line/function with the **▲/▼**, and select the value/option with **◀/▶** or **OK**.
 6. Press **←** to return to the previous menu or press **⬇️** to return to Home menu.

6.5 Subtitles

1. From the **Advanced Options** menu, select **Subtitle** and press the **OK**.
⇒ **Subtitle** menu will be displayed.

Note:

- In the TV mode, press the **TV** on the remote controller. From the on-screen keyboard, select **Subtitle** and press the **OK** to open **Subtitle** menu.

6.5.1 Analogue Subtitle

1. From the **Subtitle** menu, select **Analogue Subtitle** and press the **OK**.
2. Select **On** or **Off** and press the **OK**.
3. Press the **←** to return to the previous menu or **⬇️** to return to Home menu.

6.5.2 Digital Subtitle

1. From the **Subtitle** menu, select **Digital Subtitle** and press the **OK**.
2. Select **On** or **Off** and press the **OK**.
3. Press the **←** to return to the previous menu or **⬇️** to return to Home menu.

6.5.3 Digital Subtitle Language

1. From the **Subtitle** menu, select **Digital Subtitle Language** and press the **OK**.
2. Select **Digital Subtitle Language** and press the **OK**.
3. Press the **←** to return to the previous menu or **⬇️** to return to Home menu.

6.5.4 Second Digital Subtitle Language

1. From the **Subtitle** menu, select **Second Digital Subtitle Language** and press the **OK**.
2. Select **Second Digital Subtitle Language** and press the **OK**.
3. Press the **←** to return to the previous menu or **⬇️** to return to Home menu.

6.6 Teletext Language Selection

1. From the **Advanced Options** menu, select **Teletext** and press the **OK**.
⇒ **Teletext** menu will be displayed.

6.6.1 Digital Teletext Language

1. From the **Teletext** menu, select **Digital Teletext Language** and press the **OK**.
2. Select **Digital Teletext Language** and press the **OK**.
3. Press the **←** to return to the previous menu or **⬇️** to return to Home menu.

6.6.2 Page Decoding Language

1. From the **Teletext** menu, use the ▲/▼ to select **Decoding Page Language** and press the **OK**.
2. Press the ▲/▼ to select the page decoding language and press the **OK**.
3. Press the ⬅️ to return to the previous menu or 🏠 to return to Home menu.

6.7 Blue Screen

You can select the screen colour as blue when there is no TV broadcast signal.

1. From the **Advanced Options** menu, select **Silent Blue Screen**.
2. Use **OK** to select **On** or **Off**.
3. Press the ⬅️ to return to the previous menu or 🏠 to return to Home menu.

6.8 Automatic shut down when no signal

Select the time when the TV will switch off automatically if it does not receive any broadcast signals.

1. From the **Advanced Options** menu, select **Automatic Shut Down when no signal** and press the **OK**.
2. Select the turn off time and press the **OK**.
3. Press the ⬅️ to return to the previous menu or 🏠 to return to Home menu.

6.9 Default Channel

Select the default channel that the TV will turn on.

1. From the **Advanced Options** menu, select **Default Channel** and press the **OK**.
2. Select **Select Mode** option, and press the **OK**.
3. Select **Final State** or **User Preference**.

Note:

- When the **User's Choice** is selected, the default channel shall be selected from **Show Channels**.
4. Press the ⬅️ to return to the previous menu or 🏠 to return to Home menu.

6.10 BISS Key

Biss key is an encryption technique. You can watch a frequency encrypted with the Biss key by entering the Biss key.

Note:

- BISS Key Channel setup mode will be displayed on the menu when the Satellite (Standard) and the broadcast source Satellite is selected.
1. From the **Advanced Options** menu, select ▲/▼ **BISS Key** and press the **OK**.
 2. Press the **OK** to add a Biss key.
 3. Use the ▲/▼ to select **Frequency** and press the **OK**.
 4. Use **1...0** to enter the frequency for which you will enter the Biss key, select the ✓ key from the virtual keyboard and press the **OK**.
 5. Use the ▲/▼ to select **Symbol Rate (Ksym/s)** and press the **OK**.
 6. Use **1...0** to enter the symbol rate of the frequency for which you will enter the Biss key, select the ✓ key from the virtual keyboard and press the **OK**.
 7. Use the ▲/▼ to select **Polarization** and press the **OK**.
 8. Use the ▲/▼ to select the polarization of the frequency for which you will enter the biss key with and press the **OK**.
 9. Use the ▲/▼ to select **Programme ID** and press the **OK**.

10. Use **1...0** to enter the programme ID of the frequency for which you will enter the Biss key, select the **✓** key from the virtual keyboard and press the **OK**.
11. Use the **▲/▼** to select **CW Key** and press the **OK**.
12. Use **1...0** to enter the Biss key, select the **✓** key from the virtual keyboard and press the **OK**.
13. Use the **▲/▼** to select **Save Key** and press the **OK**.

Note:

- The BISS Key can be entered for more than one frequency. Repeat steps 2 to 13 to add Biss keys to different frequencies.

14. Press the **←** to return to the previous menu or **⏠** to return to Home menu.

6.11 TKGS Settings

Note:

- TKGS Settings are displayed on the menu only when the Channel Setup is selected as **Satellite (Operator Mode)**.

1. From the **Advanced Options** menu, select **▲/▼ TKGS** and press the **OK**.
⇒ **TKGS Setting** menu will be displayed.

6.11.1 Operation Mode

1. From the **TKGS Setting** menu, use the **▲/▼** to select **Operation Mode** and press the **OK**.
2. Use the **▲/▼** to select **Auto**, **Flexible** or **TKGS Off** and press the **OK**.

Note:

- If the TKGS operation mode is selected **Auto**, then **Change Channel Location**, **Re-locate** and **Edit Channel** are not active. Select **Flexible** or **TKGS Off** to edit the channels.

3. Press the **←** to return to the previous menu or **⏠** to return to Home menu.

6.11.2 TKGS Locator List

1. From the **TKGS Setting** menu, use the **▲/▼** to select **TKGS Locator List** and press the **OK**.
2. Press the **Click to add location** **OK**.
3. Use the **▲/▼** to select **Frequency** and press the **OK**.
4. Use **1...0** to enter the frequency for the channel location list, select the **✓** key from the virtual keyboard and press the **OK**.
5. Use the **▲/▼** to select **Symbol Rate (Ksym/s)** and press the **OK**.
6. Use **1...0** to enter the symbol rate of the frequency for the channel location list, select the **✓** key from the virtual keyboard and press the **OK**.
7. Use the **▲/▼** to select **Polarization** and press the **OK**.
8. Use the **▲/▼** to select the polarisation and press the **OK**.
9. Use the **▲/▼** to select **Programme ID** and press the **OK**.
10. Use **1...0** to select the programme ID of the frequency for the channel location list, select the **✓** on the virtual keyboard and press the **OK**.
11. Use the **▲/▼** to select **Save Location** and press the **OK**.

Note:

- More than one frequency may be entered for the TKGS Locator list. Repeat **2** to **11** add different frequencies.

12. Press the **←** twice to return to broadcast.

6.11.3 Resetting Table Version

1. From the **TKGS Setting** menu, use the ▲/▼ to select **Reset Table Version** and press the **OK**.
2. A warning message will be displayed.
3. Select **OK** to confirm the reset or select **Cancel** to cancel it, and press the **OK**.
4. Press the ← to return to the previous menu or ↻ to return to Home menu.

6.12 Signal Information

1. From the **Advanced Options** menu, use the ▲/▼ to select **System information** and press the **OK**.
⇒ – **System information** will be displayed.

Notes:







- Signal information changes depending on the current source.
 - The signal level not only depends on your receiver system, but also on the channel which is currently active. Remember this when aligning your antenna using the signal level display.
2. Press the ← to return to the previous menu or ↻ to return to Home menu.

6.13 Open Source Licenses

1. From the **Advanced Options** menu, select **Open source licenses** and press the **OK**.
⇒ **Open source licenses** will be displayed.
2. View the licenses with ▲/▼.
3. Press the ← to return to the previous menu or ↻ to return to Home menu.



7 Electronic TV Guide

The electronic programme guide offers an overview of all programmes that will be broadcast in the next week (for digital channels only).









1. Three different methods can be used to start the electronic TV guide.
 - Press the , select  from the on-screen keyboard and press the .
 - or;
 - In the TV mode, press the , and then the ; select **Programme Guide** and press the .
 - or;
 - Press  in the TV mode.
 - Electronic TV Guide will be displayed.

Notes:

- Not all channels provide a detailed TV guide.
- Many broadcasters supply the daily programme but no detailed descriptions.
- There are broadcasters which do not provide any information at all.

2. Select the channel with the /.

Note:

- Information about the actual programme is displayed in the selected television channel.
3. Press the  to select information on the next broadcast and press the  to return to the information for the current broadcast.
 4. Press the  (red) to view the programmes of the previous day, press the  (green) to view the programmes of the next day.
 5. Press the  (blue) to filter the programmes.
 6. To display the program details, press the  (yellow).
 7. Press the  to return to the previous menu or  to return to Home menu.

8 HBBTV

8.1 What is HbbTV?

With its modern structure, content and high definition (HD) pictures and videos, HbbTV is a new technology where broadcast and the broadband can be used together and which permits access to interactive applic-

ations that the broadcast provides through internet. The TV must be connected to internet to receive HbbTV broadcast.

When you switch to a TV channel that offers HbbTV service, the relevant message will be displayed.

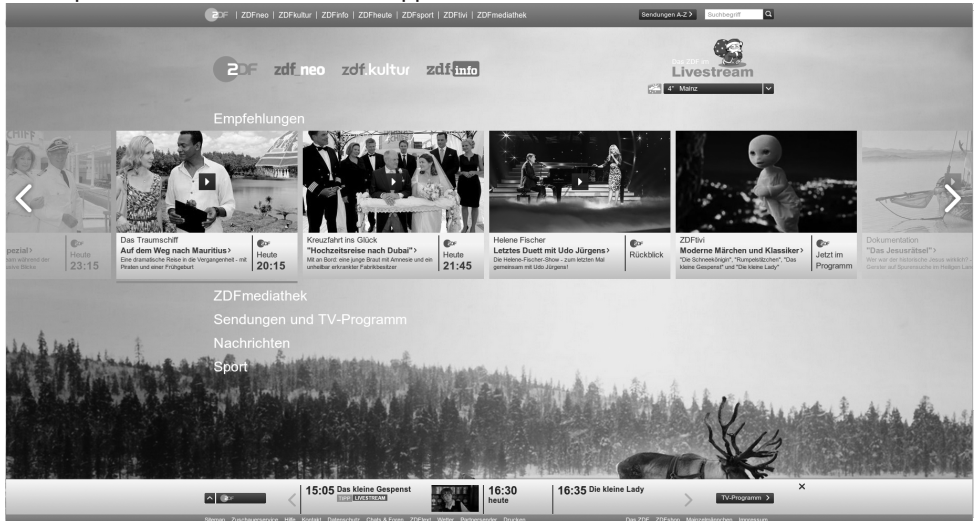

8.2 Using HbbTV

When you switch to a TV programme that supports HbbTV, an info message will appear stating that HbbTV broadcast is available.

Note:

- To activate HBBTV, the HBBTV Support shall be enabled from HBBTV Settings.

1. Press **○** (red) to open HbbTV.

⇒ Information regarding the service will appear on the screen. Additionally, coloured buttons necessary for browsing the menus will also appear.

Notes:

- The range of subjects and selection of individual subjects are subject to the programme provider.
- Numeric buttons between **1** and **0** are used for additional functions.

2. Press **○** (green), **○** (yellow) or **○** (blue) to select the desired subject field.
3. In the subject field you have selected, use **◀/▶/▲/▼** to select the desired option and confirm with the **OK**.
4. Press **○** (red) to close HbbTV.

Note:

- If navigation does not work in HbbTV mode, press the **⏪** to exit the function.

8.3 HBBTV Settings

1. To switch to TV mode from Home menu, press **⏪**.
2. Use the **⚙** and then the **◀/▶** to select **Advanced Options** and press the **OK**.

- Use the ▲/▼ to select **HBBTV Settings** and press the **OK**.
- ⇒ **HBBTV Settings** menu will be displayed.

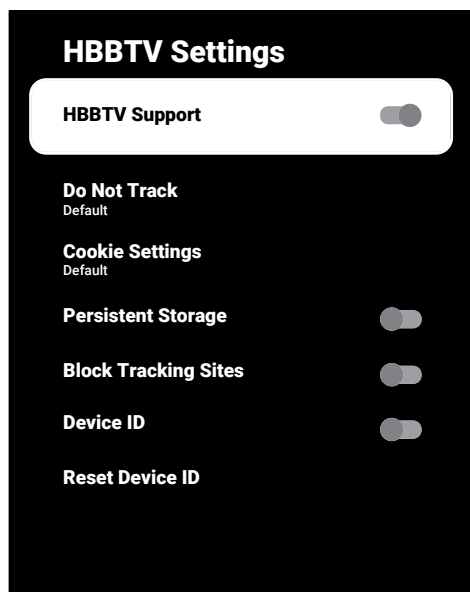

8.3.1 HBBTV Support

You can turn off HbbTV, by this way warnings for HbbTV are not displayed on channels broadcasting HbbTV.

- Use the ▲/▼ to select **HBBTV Support** and use **OK** to select **On** or **Off**.
- Press the ← to return to the previous menu or **h** to return to Home menu.

8.3.2 Watching Preferences

Set your watching preference for HbbTV services.

- Use the ▲/▼ to select **Do Not Track** and press the **OK**.
- Use the ▲/▼ to select **On, Off** or **Default** and press the **OK**.
- Press the ← to return to the previous menu or **h** to return to Home menu.

8.3.3 Cookie Settings

Set your cookie preference for HbbTV services.

- Use the ▲/▼ to select **Cookie Settings** and press the **OK**.
- Use the ▲/▼ to select **Block 3rd party cookies** or **Default** and press **OK**.
- Press the ← to return to the previous menu or **h** to return to Home menu.

8.3.4 Persistent Storage

Turning permanent storage on/off for HbbTV services.

- Use the ▲/▼ to select **Persistent Storage** and use the **OK** to select **On** or **Off**.
- Press the ← to return to the previous menu or **h** to return to Home menu.

8.3.5 Block Tracking Sites

Block/allow tracking sites.

- Use the ▲/▼ to select **Block Tracking Sites** and use the **OK** to select **On** or **Off**.
- Press the ← to return to the previous menu or **h** to return to Home menu.

8.3.6 Device ID

Turning the Device ID on/off.







- Use the ▲/▼ to select **Device ID** and use **OK** to select **On** or **Off**.
- Press the ← to return to the previous menu or **h** to return to Home menu.

8.3.7 Reset Device ID

- Use the ▲/▼ to select **Reset Device ID** and press the **OK**.
- To confirm the reset, select the **OK** and press the **OK** or press the ← to cancel the reset.
- Press the ← to return to the previous menu or **h** to return to Home menu.







9 Teletext

9.1 TOP Text or FLOF Text Mode









1. To switch to the teletext mode, press the , select  from the on-screen keyboard and press the .
2. Select teletext pages directly with the  or step by step with the .
3. Select the subpages of the teletext pages with .



At the bottom of the screen, you will see an information line consisting of a red, green and, depending on the station, yellow and blue text field. Your remote control has buttons with the corresponding colours.

4. Press the  (red) to go to the previous page.
5. Press the  (green) to select subject.
6. Press the  (yellow) to select section.
7. Press the  (blue) to go to the next page.
8. To exit the teletext mode, press the , select  from the on-screen keyboard and press the .

9.2 Normal Text Mode

1. To switch to the teletext mode, press the , select  from the on-screen keyboard and press the .
2. Select teletext pages directly with the .
3. Press  to go to the next page or previous page.
4. To exit the teletext mode, press the , select  from the on-screen keyboard and press the .

Calling the subpage directly

If the selected teletext page contains subpages, the number of the selected subpage as well as the total number of pages is displayed.

1. Press the  to select a subpage.

10 USB Recording

10.1 Information on Recording and Playing Television Programmes

- Recording and reproducing programmes, this can only be done with digital television stations (DVB-S, DVB-T and DVB-C).
- The digital television stations (DVB-S, DVB-T and DVB-C) you are able to record and playback also depend on the broadcasting station.
- Besides recording and playing programmes, the Timeshift function can only be carried out using an external data medium (hard drive or USB stick).
- Recordings can be made with most data mediums on the market. However, we cannot guarantee operation for all data media.
- Recording can only be done on USB memory sticks and hard disks with FAT and FAT32 format.
- If you record a programme on an external data medium, you can only watch it on your television. You cannot watch this program on any other device.
- If you send your television to be repaired and hardware components need to be replaced, you might not be able to play the recordings again on the repaired television.
- Arçelik isn't responsible for any loss of data stored on any external storage device.
- It is recommended to play the files saved on DTV by PVR media player.

10.2 Possible Limitations When Using an External Data Medium

- Depending on the broadcasting station, you may experience various restrictions on some functions from some television stations.
- **Arçelik has no influence on these restrictions.**
- Recording a programme on the external data medium can be disabled by the broadcaster.

- **If URI* protected! PVR function is blocked** appears, then recording or time shift is restricted (one recording possible) or disabled (recording not possible) by the broadcaster.
- *URI = user rights information.
- If you record and save a programme on the archive of an external data medium, playback can be restricted. The broadcaster can allow you to see this programme one or more times but could also just make it available for a certain period of time.
- Stations from which children are protected, immediately require a PIN number before recording starts. If this authorization is not given, the recording may not start.

10.3 Connecting External Data Media

- It is advised to put the television on stand-by mode before connecting the External Data medium.
- Before disconnecting the external data medium, the television shall first be switched to standby, otherwise files can be damaged.
- There are two USB inputs on the television, namely **USB1** and **USB2 (HDD)**.
- A USB device that needs additional power (e.g. external hard drive) is connected to the **USB2 (HDD)** port.

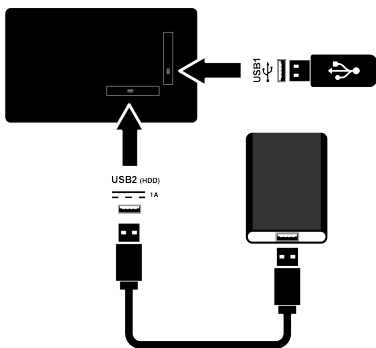

1. Plug the external hard drive to the **USB2 (HDD)** USB interface or plug the memory stick to the **USB1** interface.

Notes:

- **USB1** USB1 port of the TV supports a current of 500 mA current according to the USB standard. Devices such as external hard drive and etc. that consume more power can only be connected to the **USB2 (HDD)** USB interface of the television.
- If you are using a power cable for the external hard drive that you have connected to the **USB2 (HDD)** USB interface, then the power cable of the external hard drive shall also be unplugged when the TV is turned off.
- You must not disconnect the USB Device from the TV while a file on the USB Device is being read by the TV.

10.4 USB Recording Settings

1. Press the on the Home screen.
2. Press the and use the to select **Save**.
3. Use the to select **Device Information** and press the .

4. Select the external data media connected to the TV and press the .
- ⇒ **Device Info Setting** menu will be displayed.

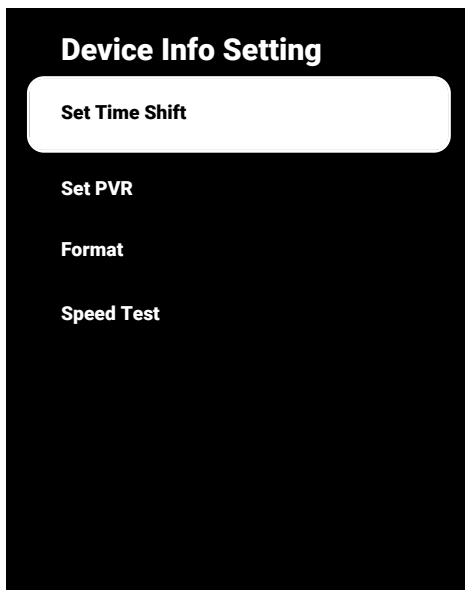

Note:

- Additional operations are explained in the following sections.

10.4.1 Formatting the Data Medium

Important:

- Formatting external data medium causes all data in the data medium to be permanently deleted.
1. In the **Device Info Setting** menu, use the button to select **Format** and press the .
- ⇒ A warning message will be displayed.
2. Select **Format** to confirm the formatting operation or select **Cancel** to cancel it, and press the .
- ⇒ When the formatting is complete, the **Device Information** menu is displayed.

10.4.2 Selecting Data Medium for Record/Time shift

If more than one external data medium is connected to the TV set, you can set different data media for record/time shift or assign both records to one data medium.

1. In the **Device Info Setting** menu, use the ▲/▼ to select **Set Time Shift** and/or **Set PVR** and press the **OK**.
2. As per the selection you have made in the **Device Information** menu, **TSHIFT**, **PVR** or **PVR/TSHIFT** is displayed.

Notes:

- You can connect two different external data media to the TV and select one as **PVR** record and the other one as **TSHIFT** record.
- Functions do not work if no external data medium is assigned for recording/time shift.

10.4.3 Data Medium Test

You can test the external data media to see if it is suitable for the required functions.

1. From the **Device Info Setting** menu, use the ▲/▼ to select **Speed Test** and press the **OK**.
2. The test result of the data medium will be displayed on the screen within 10 to 60 seconds as per the volume of the drive.
3. Select **Exit** and press the **OK** to exit the Speed Test menu.

10.5 Turning the Time Shift Function On/off

You can turn time shift off or on with this feature.

1. In the TV mode, press the **⊙** and use the ▼ to select the **Save** tab.
 2. Use the ► to select **Time Shift Mode** and press the **OK**.
- ⇒ **Time Shift Mode** menu will be displayed.

3. From **Time Shift Mode**, use **OK** to select **On** or **Off**.
4. Press **⬅** to return to the broadcast.

10.6 Disk Setup the Time Shift Drive

If you are going to connect an external data medium to TV for the first time and use it for time shift, a disk setup is required.

10.6.1 Automatic Installation

1. Connect the external data medium to the USB input of TV.

Note:

- The **Time Shift Mode** shall be selected as, **On** to be able to install the Time Shift disk setup.
- Time shift functions are on the on-screen keyboard. To open the on-screen keyboard, press the **⌨**, and then select the relevant function.

2. During the broadcast, select the **⏸** from the on-screen keyboard and press the **OK**.

⇒ **Disk Setup** menu will be displayed.

3. Select **Auto** and press the **OK**.
- ⇒ The external data medium is automatically configured and the **Disk Setup Complete** message displayed.







Notes:

- This should be done when an external data medium is first connected to the TV set or when the external data medium is formatted by the TV set.
 - An external drive with a volume larger than 4 GB is required for this operation.
 - Auto set-up creates 4GB of time shift space on drives below 32GB and 16GB on drives above 32GB.
4. Press **⬅** to return to the broadcast.





10.6.2 Manual Set-up

1. Connect the external data medium to the USB input of TV.

Note:

- The **Time Shift Mode** shall be selected as, **On** to be able to install the Time Shift disk setup.
 - Time shift functions are on the on-screen keyboard. To open the on-screen keyboard, press the , and then select the relevant function.
2. During the broadcast, select the  from the on-screen keyboard and press the .
 - ⇒ **Disk Setup** menu will be displayed.
 3. Use the  to confirm the **Manual** item with the .
 4. Select **Format** to format the data medium or select **Skip** to continue without formatting, and press the .

Important:

- It is recommended to format the data medium for better performance.
 - This action will delete all data on the external data medium.
5. The formatting warning message will be displayed. Select **Format** and press the .
 - ⇒ Formatting progress is displayed on the screen.
 6. When formatting is complete, select the size you want to reserve for time shifting according to the size of the data medium with the / and press the .
 - ⇒ The data medium is manually configured and the **Disk Setup Complete** message is displayed.
 7. Press  to return to the broadcast.





10.7 Pausing Programs with Time Shift and Continuous Recording

You can pause any programme you are watching. For instance, if the phone rings when you are watching a movie, you can pause the movie and resume it after the











call without missing anything. The image of the last scene is stopped and recorded to the external data medium for time shift. With the continuous recording feature, TV records the channel you are currently watching as much as the time shift memory you create on external data media. Thus, you can rewind on the channel you are watching.

Note:

- Use an external USB disk drive for an uninterrupted Permanent Time Shift.
- Time shift functions are on the on-screen keyboard. To open the on-screen keyboard, press the , and then select the relevant function.

1. During the broadcast, select the  from the on-screen keyboard and press the .
 - ⇒ Television picture is paused and delay time is displayed.
2. To continue the broadcast, select the  from the on-screen keyboard and press the .
 - ⇒ The system continues recording the broadcast while you are watching it.

Notes:

- The following functions can be used in the Time Shift mode.
 - For fast rewind, desired speed; press the  or select the  from the on-screen keyboard and press the .
 - For fast forward, desired speed; press the  or select the  from the on-screen keyboard and press the .
 - For pausing, select the  from the on-screen keyboard and press the .
3. To stop the time shift, select the  from the screen keyboard and press the .

10.8 Recording Programmes

You can record a TV channel. Record data are stored on external data media and these recordings are managed by the TV set.

A memory of 44 MB up to 110 MB is required for a 1 minute record.

Notes:

- Recordings can only performed on USB memory sticks and hard drives with FAT and FAT32 format.
- If the product cannot be recovered from the data playing/sharing/recording mode due to electrostatic discharge, user intervention will be required.
- If you remove the external data media during recording, then the recording is cancelled automatically and no data is recorded onto the external data media.

1. Select the channel with the **1...0** to start recording.
2. Press the **⌨** on the remote controller, select **◆** from the on-screen keyboard and press the **OK**.
 - ⇒ Recording information will be displayed: Recording symbol, channel name, programme and recording time.
 - ⇒ These information will disappear after a short while, the **REC** symbol and the recording time appear in the lower left corner of the screen.

10.8.1 Switching the TV to Standby During Recording

1. Select the channel with the **1...0** or to start recording.
2. Press the **⌨** on the remote controller, select **◆** from the on-screen keyboard and press the **OK**.
3. Press the **⏻** to switch the TV set to the standby mode.

10.8.2 Recording a Programme from the Channel List

1. Press the **OK** to open the channel list.
2. Select a channel with the **▲/▼** and press the **OK** to confirm.
3. Press the **⌨** on the remote controller, select **◆** from the on-screen keyboard and press the **OK**.
 - ⇒ Recording information will be displayed: Recording symbol, channel name, programme and recording time.
 - ⇒ These information will disappear after a short while, the **REC** symbol and the recording time appear in the lower left corner of the screen.
4. To stop recording, press the **⌨**, select **■** from the on-screen keyboard and press the **OK**.













10.9 Sleep Timer

10.9.1 Scheduling a Record

1. Press **⌚** in the TV mode.
2. Use the **▼** and then the **◀/▶** to select **Programme List** and press the **OK**.
 - ⇒ **Programme List** menu will be displayed.
3. Select **Add** and press the **OK** to schedule the recording of the broadcast.
4. Enter the required information for recording and select **OK** with the **○** (green).
 - ⇒ The recording you have scheduled will be displayed in the **Programme List** menu.

10.9.2 Adding a Record Timer Using the Electronic Programme Guide

Electronic programme guide data can be used for recording.



- Three different methods can be used to start the electronic TV guide.
 - Press the , select  from the on-screen keyboard and press the .
 - or;
 - In the TV mode, press the , and then the , select **Programme Guide** and press the .
 - or;
 - Press  in the TV mode.
 - Electronic TV Guide will be displayed.
- Select the channel you want to add a recording timer with the /.
- Select the programme you want to add a recording timer with the / and confirm with the .

⇒ **Programme List - Add** menu will be displayed.

- From the **Programme Type** item, select **Save**.
- From the **Repeat Type** item, select (**Once, Week or Every Day**).

Note:

- To add a recording timer for a programme at a time interval other than the broadcast time specified in the electronic programme guide, select the **Event Model** item, and then select **Timing Schedule**.







- To save the settings, press the  (green).
- Press the  to return to the previous menu or  to return to Home menu.

Notes:













- A warning is displayed before the timer recording starts and counts down for 15 seconds to allow you to switch to the channel. At the end of 15 seconds, the channel to be recorded appears automatically.

- If the timer recording starts during playback, playback stops. If you do not select **Yes** option in the warning prompt, recording will start automatically at the end of the countdown.
- Only for UPC customers Note:** Parts of previous or next files can be included into the record while the programme is being recorded resulting from possible Programme Guide errors. In such cases, keep in mind that the highest family protection level will apply for the whole recording if one or more of those programmes have any level of family protection.

10.9.3 Adding a Record Timer By Entering the Information Manually

- In the TV mode, press the  and use the  to select the **Save** tab.
- Use the  to select **Programme List** and press the .
- Info** menu will be displayed. Use the  to select **Add** and confirm with the .

Note:

- If there is a previously programmed timer, the Schedule List menu is displayed without the **Info** menu being displayed. Press the  (yellow) to add a timer in this case.
- Select **Channel Information** option and press the . Use the / to select the channel you will be recording and press the .
 - Select **Start Date** option and press the . Select year, month and day with the ... and press the  (green).
 - Select **Start Time** and press the . Select hour, minute and seconds with the ... and press the  (green).

7. Select **Stop Time** and press the **OK**. Select hour, minute and seconds with the **1** ... **0** and press the **OK** (green).
8. Select **Programme Type** and press the **OK**. Use the **▲/▼** to select **Save** and press the **OK** (green).
9. Select **Repeat Type** and press the **OK**. Use the **▲/▼** to select (**Once, Every Day** or **Week**) and press the **OK** (green).
10. From the **Event Model** item, use the **◀/▶** to select **Timing Schedule** and press the **OK** (green).
11. To save the timer, press the **OK** (green).
12. Press the **←** to return to the previous menu or **Home** to return to Home menu.

10.9.4 Editing the Recording Timer

You can delete programmed timers.

1. In the TV mode, press the **⊙** and use the **▼** to select the **Save** tab.
2. Use the **▶** to select **Programme List** and press the **OK**.
 - ⇒ The scheduled recording timers will be displayed.
3. Select the recording timer you want to edit with the **▲/▼** and press the **OK** (red).
4. Edit recording timer.
5. To save the changes, press the **OK** (green).

10.9.5 Deleting a Recording Timer

You can delete programmed timers.

1. In the TV mode, press the **⊙** and use the **▼** to select the **Save** tab.
2. Use the **▶** to select **Programme List** and press the **OK**.
 - ⇒ The scheduled recording timers will be displayed.

3. Select the recording timer you want to delete with the **▲/▼** and press the **OK** (blue).
4. Use the **◀/▶** to select **Yes** or **No** to delete the timer or select **No** and press the **OK** to cancel deletion.

10.10 Playback

Programmes that are recorded are stored in an external data medium. You can display the archive on the external data media from the **Recorded Files List** menu.

10.10.1 Playing a Recording from the List of Recorded Files

Selecting a broadcast from the recorded files list









1. In the TV mode, press the **⊙** and use the **▼** to select the **Save** tab.
2. Use the **▶** to select **Recorded Files List** and press the **OK**.
 - ⇒ **Recorded Files List** will be displayed.
3. Press the **▲/▼** to select the broadcast you want to play and press the **OK** to start playing.
4. To pause the playback, press the **⏸**, select **⏸** from the on-screen keyboard and press the **OK**.
5. To stop the playback, press the **⏹**, select **⏹** from the on-screen keyboard and press the **OK**.

10.10.2 Forward/Reverse Picture Search

1. Press the repeatedly during playback to select the playback speed (2x, 4x, 8x, 16x, or 32x).
 - ⇒ The picture is searched backwards.
2. Press the repeatedly to select the playback speed (2x, 4x, 8x, 16x, or 32x).
 - ⇒ The picture is searched forwards.

10.11 Deleting Broadcasts from the Recorded Files List

You can delete recorded broadcasts from the Recorded Files list.

1. In the TV mode, press the  and use the  to select the **Save** tab.
2. Use the  to select **Recorded Files List** and confirm with the .
⇒ **Recorded Files List** will be displayed.
3. Select the recording you want to delete with the / and press the  (yellow).
4. To confirm deleting, select **Yes** and to cancel deleting, select **No**.
5. Press  to return to the broadcast.

11 USB Player

11.1 File Formats

Your television can be operated via the USB input with the following file formats:

11.1.1 Video Data

Video compression / decompression (codec) is intended for decreasing the storage area without sacrificing the picture quality. Your TV set allows you to play compressed video data with XVID, H. 264/MPEG-4 AVC (L4.1, Ref. Frames: 4), MPEG-4, MPEG-2, MPEG-1, MJPEG, MOV standards.

File extensions supported by the device: ".avi", ".mkv", ".mp4", ".ts", ".mov", ".mpg", ".dat", ".vob", ".divx". In addition to video data, these files also contain audio data compressed and "packaged" by MP3, AAC or Dolby Digital.

Format (codec) information is embedded within the file content and may differ depending on the file extension. ".avi", ".mkv" or ".divx" files containing divx codec within are not played back.

11.1.2 Audio Data

Your television can play audio data coded with MP3, AAC standards.

MP3 indicates MPEG-1 Volume Level 3 and is based on the MPEG-1 standard that was developed by MPEG (Motion Picture Expert Group).

AAC indicates the Advanced Audio Coding and is developed by MPEG. AAC provides higher audio quality with the same data rate (bit rate).

File extensions supported by the device: ".mp3", ".mp2", ".m4a", ".aac", ".wav"
MP3 files can be organized into folders and sub-folders similar to the files on a computer.

11.1.3 Picture Data

Your television can display picture data in JPEG, PNG and BMP formats.

JPEG stands for Joint Picture Experts Group. This process is intended to compress picture files.

PNG and BMP are designed to compress picture data without any losses.

Picture files can be saved on a data medium along with other file types.

Such files can be organised as folders and subfolders.

11.2 Connecting External Data Media

It is advised to put the television on standby mode before connecting the External Data medium. Connect the device and then switch the television on again.

Before disconnecting the data medium, the television must first be switched to standby, otherwise files can be damaged.

Notes:

- **USB1** port of the TV supports a current of 500 mA current according to the USB standard. Devices such as external hard disk and etc. that consume more power can only be connected to the **USB2 (HDD)** interface of the television.
- If you are using a power cable for the external hard drive that you have connected to the **USB2 (HDD)** USB interface, then the power cable of the external hard drive shall also be unplugged when the TV is turned off.
- You must not disconnect the USB Device from the TV while a file on the USB Device is being read by the TV.
- A bi-directional data transfer as defined for ITE (Information Technology Equipment) devices in EN 55022/EN 55024 is not possible.
- USB transfer is not an operating mode in itself. It is only an additional function.

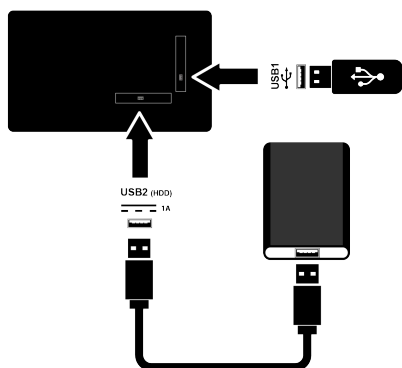

1. Plug the external hard drive to the **USB2 (HDD)** port or plug the memory stick to the **USB1** port of the TV set.

11.3 Removing the External Data Medium

Before removing the external data medium, disconnect the data medium from TV.

1. Press **Home**.
2. **Settings** select Settings and press the **OK**.
3. Use the **Down** to select **System** and press the **OK**.
4. Use the **Down** to select **Storage** and press the **OK**.

5. Select the external data media that you want to remove with the **Up/Down** and press the **OK**.
6. Select **Remove** and press the **OK**.
⇒ - **removed safely** message will be displayed.
7. Remove the data medium from the socket.

11.4 Multi Media Player menu

Multi Media Player file browser shows video, audio, picture and text data on external data medium.

If an external data medium contains different file formats, you can disable data (Video file, Audio file, Picture file or Text file) that you do not need to play/display with the file format selection, so that you can only play files in the format you want to view.

1. Press **Home**.
2. From the **Applications** tab, use the **Left/Right** to select **USB** application and press the **OK**.
⇒ File format selection will be displayed.
3. Use the **Left/Right** to select the file format that you want to play as **Video, Photo, Music** and press the **OK**.
⇒ File browser menu for the file format you have selected will be displayed.

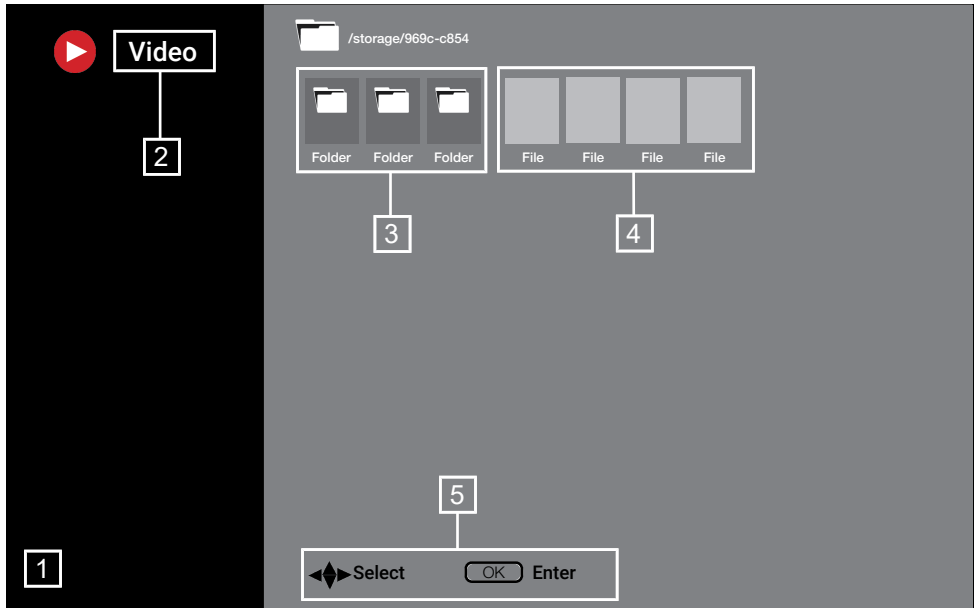

File browser

1. File browser
2. Data type
3. Data medium folders
4. Data medium files
5. Options

11.5 Playback - Basic functions

1. Select the file you want to play from the file browser with the ◀/▶/▲/▼ and press the **OK**.
2. Press the **OK** to pause playback.
3. Press the **OK** to continue playback.
4. Press the ⏪ to end playback.
 - ⇒ The file browser appears.

Notes:

- It is possible that some files that are supported by the USB player do not work due to some problems that may arise depending on how such files are created (compression) although they have the supported file extension.
- Movies you will be watching from the movie file only supports subtitles with.srt,. sub,. ass,. ssa,. smi format.

Names of the subtitle and movie files must be the same. Otherwise, subtitle cannot be displayed.

11.6 Additional Playback Functions

Depending on the file formats used, it is possible to use the following additional functions.







11.6.1 Viewing Information in All File Formats

1. Press the **ⓘ** during playback.
2. Select **Show Info** option, and press the **OK**.
 - ⇒ File information will be displayed.
3. Press the ⏪ to exit the menu.

11.6.2 Forward/Reverse Picture Search







1. Press the ◀/▶ on the remote controller to jump to the desired time during playback.

11.6.3 Moving to a Specific Time in a Video

1. Press the  during playback.
2. Use the / to select **Search** and press the .
3. Enter the time that you want to move to with the  ...  and press the .



11.6.4 Repeat Function

(only video and audio files)

1. Press the  during playback.
2. Use the / to select **Repeat** and press the .
3. Use the / to select **N/A, Repeat One** or **Repeat All** and press the .

11.6.5 Picture Settings In Video Files

You can change the display settings while playing video files.



1. Press the  during playback.
 2. Select **Picture Settings** and confirm with the .
- ⇒ **Picture** menu will be displayed.

Note:

- Refer to Picture Settings [▶ 30] section for other settings.

11.6.6 Sound Settings in Video and Audio Files

You can change the audio settings while playing video and audio files



1. Press the  during playback.
2. Select **Sound Settings** and press the .

Note:

- For other settings, refer to the **Sound Settings** section.

11.6.7 Shuffling on Audio Files

You can put the audio files in the external data medium on shuffle.









1. Press the  during playback.
 2. Select shuffling option **On** and press .
- ⇒ The tracks in the external data medium are played in shuffle.

Note:





- Select **Shuffle Off** to play the tracks in the external data medium in order.

11.6.8 Playing Audio Files with the Screen Off

You can turn off the screen while playing audio files on external data media.







1. Press the  during playback.
 2. Use the / to select **Picture Off** and press the .
- ⇒ Power menu will be displayed.
3. Use the / to select **Picture Off** and press the .
- ⇒ TV Screen turns off and audio files continue to play.
4. Press the  to turn the picture on again.

11.6.9 Rotating the Picture Display (only picture files)

1. Pictures can be rotated by 90°.
 2. Press the  during playback.
 3. Use the / to select **Rotate** and press the .
- ⇒ The picture will turn by 90° clockwise or counterclockwise.

11.6.10 Enlarging the Picture Display (Zoom)

(only picture files)

1. Press the  during playback.
2. Use the / to select **Zoom** and press the .
3. Use / to select **1X**, **2X** or **4X** and press the .

12 Google TV™

12.1 Terms, Conditions and Privacy

During the first set-up of your TV set, a Terms of Service page is shown by Google for you to accept or decline. This page has buttons for the "Google Terms of Service", "Google Privacy Policy" and "Google Play Terms of Service", along with Accept option.

Please read these agreements with their visit details on the relevant web pages and select the Accept option accordingly. If you don't select Accept option at this step, you won't be able to use Google TV features.

Again on initial set-up, Smart TV Terms of Service are displayed. In this contract, the terms of the services provided on your television are explained in detail and detailed information about data processing is given. Please read this agreement carefully.

12.2 Signing in with Google account



Skip this step if you signed in with an existing Google account in the initial set-up.

1. From the **Home Screen** menu, select **Control Panel** and press the **OK**.
2. Select **Settings** and press the **OK**.
3. Select **Set up Google TV** option, and press the **OK**.
⇒ **Google TV** menu will be displayed.
4. Select **Set up Google TV** option, and press the **OK**.
⇒ **Sign in** menu will be displayed.
5. Enter the e-mail address with the screen keyboard.
⇒ Select **→** on the display and press the **OK**.

6. Enter the password for the account with the screen keyboard.
⇒ Select **→** on the display and press the **OK**.
 7. Follow the instructions displayed on your TV and on the screen of your phone.
⇒ **Terms of Service** menu will be displayed.
 8. Select **Agree** option, and press the **OK**.
⇒ **Google Services** menu will be displayed.
 9. Select **Agree** option, and press the **OK**.
⇒ **Google Assistant** menu will be displayed.
 10. Select **Continue** option, and press the **OK**.
 11. To perform a search in all supported TV applications, select the **Allow** option and press **OK**, or select the **No** option and press **OK**.
 12. Select the subscribed applications you want to install from the list of the recommended applications and select the **Confirm** option and press **OK**.
⇒ **Tuner Mode** menu will be displayed.
 13. If a channel search was performed before, select **Skip** and press **OK**.
- Note:**
- Please continue from page 19 according to your antenna type if you have not performed channel search before.
14. Select **FINISH** option, and press the **OK**.
⇒ Your Applications are being loaded menu will be displayed. Wait for the applications to be loaded.
 15. **Start exploring** menu is displayed, press **OK** button to complete signing in.

12.3 Adding a Different Google Account







You can add more than one account to Google TV and each user can create their own profiles to enjoy a more personalized experience with specific suggestions and personal watchlist.



1. Press 
 - ⇒ **Choose an account** menu will be displayed.
2. Select **Add account** and press the 
 - ⇒ **Add account** menu will be displayed.
3. Select **Add account** and press the 
 - ⇒ **Sign in** menu will be displayed.

4. Follow the instructions on screen.

Note:

• Below information are related to logging on to the TV.

5. Enter the e-mail address with the screen keyboard.
 - ⇒ Select  on the display and press the .
6. Enter the password for the account with the screen keyboard.
 - ⇒ Select  on the display and press the .
7. Follow the instructions displayed on your TV and on the screen of your phone.
 - ⇒ **Terms of Service** menu will be displayed.
8. Select **Agree** option  and press.
 - ⇒ **Google Services** menu will be displayed.
9. Select **Agree** option  and press.
 - ⇒ **Google Assistant** menu will be displayed.
10. Select **Continue** option, and press the .









11. To perform a search in all supported TV applications, select the **Allow** option and press , or select the **No** option and press .

12. Select the subscribed applications you want to install from the list of the recommended applications and select the **Confirm** option and press .

13. Application installation will be completed and **Home Screen** menu will be displayed.

12.4 Adding a Google Account for Children

Create a viewing experience with parental controls and screen time limits for children.

1. Press 
 - ⇒ **Choose an account** menu will be displayed.
2. Select **Add account** and press the 
 - ⇒ **Add account** menu will be displayed.
3. Select **Add a kid** and press the .
4. Press the **Get started** .
5. If more than one user has been added, select the user to set up the child profile and confirm with 
 - ⇒ The parental account and children accounts connected to this account are displayed.
6. Select the child account you want to add and press the .
7. Enter the password for the account of your child with the screen keyboard.
 - ⇒ To continue, select  and press the .
 - ⇒ **Select parent** menu will be displayed.
8. Select parent account and press 
 - ⇒ Parent password menu is displayed.

9. Enter the parent password with the screen keyboard.
 - ⇒ Select **→** on the display and press the **OK**.
10. Follow the instructions displayed on your TV and on the screen of your phone.
 - ⇒ **Set PIN** menu will be displayed.
11. Select **Next** and press the **OK**.
 - ⇒ **Create PIN** menu will be displayed.
12. Select **Got it** option, and press the **OK**.
13. Enter the PIN code.
14. Re-enter the PIN code and confirm.
 - ⇒ **Select Apps** menu will be displayed.
15. Select **Next** and press the **OK**.
 - ⇒ **Apps for kids** menu will be displayed.
16. Select the application you want to install and press **OK**.
17. When you want to allow applications on the device, select the application and press **OK**.
 - ⇒ A warning screen will be displayed.
18. Select **Allow** option, and press **OK**.
19. Select **Install & continue** option, and press the **OK**.
20. Select **Next** and press the **OK**.
 - ⇒ Child profile usage instructions is displayed.
21. Press the **OK** repeatedly to continue.
22. Select **Let's go** option, and press the **OK**.
23. Adding a child profile process is completed and the child profile's home screen **Home Screen** is displayed.

12.5 Changing User Accounts

If more than one account has been added to Google TV, you can switch between user accounts or switch to a child's account if added.

1. Press **Ⓐ**.
 - ⇒ **Choose an account** menu will be displayed.
2. Use the **◀/▶** to select the account you want to switch to and press the **OK**.
3. **Home Screen** of selected account will be displayed.

Note:

- If you want to switch accounts when a child profile is selected, you need to enter the PIN code you set up while creating the child profile.

12.6 Removing User Accounts







Remove the accounts and account settings added to Google TV.

1. From **Home Screen** menu, press **Ⓐ**.
2. Use the **◀/▶/▲/▼** to select **⚙️ Settings** and press the **OK**.
3. Use the **▼** to select **Accounts and Profiles** and press the **OK**.
 - ⇒ **Accounts and Profiles** menu will be displayed.
4. Select the account you want to remove and press the **OK**.
5. Select **Remove** option, and press the **OK**.
 -
 - ⇒ A warning message will be displayed.
6. Select **Remove** to complete the operation or select **Cancel** to cancel it, and press the **OK**.

12.7 User Account Settings

You can change the settings of an account added to Google TV.

1. From **Home Screen** menu, press **Ⓐ**.

2. Use the ◀/▶/▲/▼ to select  Settings and press the .
3. Use the ▼ to select **Accounts and Profiles** and press the .
 - ⇒ **Accounts and Profiles** menu will be displayed.
4. Select the account for which you want to view settings and press the .
5. Select the desired line/function with the ▲/▼ or select the value/option with ◀/▶ or .
6. Press the  to return to the previous menu.

12.8 Home Menu (Home Screen)

Your TV has an Google TV operating system. Just like your smartphone or tablet, you can find the most practical applications you want on your new Google TV. Just connect your TV to your home network and the Internet to watch TV, play online games, use videos, pictures, music, social sharing apps, the most popular news and sports apps.





As with your Android smartphone or tablets, the Home Screen menu is the centre of your TV. You can decide what to watch by browsing through the Home Screen menu, app and live TV entertainment options. Home Screen menu has channels to let you discover great content from your favourite apps.

To access the home menu of the TV set, simply press the .

Note:

- Appearance of Home menu may change with Google software updates.

12.9 Opening the Home menu

1. Press .
2. With the ◀/▶/▲/▼, press the  to select and open/start an application.
3. Press the  repeatedly or press the  to return to home screen.

Note:

- When **Home Screen** is opened, application/content playing in the background is stopped. You need to reselect app or content from Home screen to continue.



Home Screen

Applications

Library



Google TV

Prime Video



Your apps



Continue watching



12.10 Applications







You can find your Favourite Applications under the Your Applications tab under the Home Screen menu.

You can download apps and games from Google Apps to TV just like with smart phones and tablets.

You can only download apps and games which are compatible with your TV. These may differ from apps and games for smart phones/tablets.

To download applications from Google Apps, television must be connected to the Internet and must be logged in with a Google account

12.10.1 Downloading Applications from Google Apps



1. Press .
 2. In the **Home Screen** menu, select **Applications** tab.
 - ⇒ Home screen of the applications will be displayed.
 3. With / / / , search and select any application from **App categories, Apps from my other devices, Recommended for you, Listen to the music you love, Movies + TV, Featured, Entertainments apps** or search bar and press .
 - ⇒ My application explanation screen will be displayed.
4. Select **Load** and press the .
 - ⇒ The application will be downloaded and installed on your TV.

Note:

- Depending on the size of the application and your internet speed, loading time of the application may vary.

12.10.2 Starting an Installed Application

1. Press .
2. In the **Home Screen** menu, select **Your apps** tab.





3. From the applications tab, select the application you want to start with the /  and press the .

⇒ Main screen of the app will be displayed.



4. Press the  to end the application.

12.10.3 Sorting the Applications on Home Menu











Sort apps in applications tab of Home menu according to your personal preference.

1. Press .
2. In the **Home Screen** menu, select **Your apps** tab.
3. Select the application you want to replace and press and hold the  for 3 seconds.
 - ⇒ Application menu will be displayed.
4. Select **Move** option, and press the .
5. Move the channel to its new position with the  and press the .

Note:

- Repeat steps 2 to 4 to sort other applications.
6. Press  or  to return to the home screen menu.

12.11 Application Settings

1. Press .
2. Use the / / /  to select  Settings and press the .
3. Use the  to select **Applications** and press the .
- ⇒ Applications menu will be displayed.
4. Use the  to select **Show all applications** and press the .
- ⇒ All applications are displayed.

Note:

- Additional operations are explained in the following sections.

12.11.1 Removing Installed Applications

You can remove applications you don't need.

1. Select the application you want to remove from **All Apps** menu and press the **OK**.
⇒ Application detail will be displayed.
2. Select **Remove** option, and press the **OK**.
3. Select **OK** to confirm removal of application or select **Cancel** to cancel it, and press the **OK**.
4. Press the **←** to return to the previous menu.

12.11.2 Force Quitting of Applications

If an application doesn't respond for any reason, you can force quit it.

1. Select the application you want to remove from **All Apps** menu and press the **OK**.
⇒ Application details are displayed.
2. Select **Force Stop** option, and press the **OK**.
3. Select **OK** to confirm the quitting operation or select **Cancel** to cancel it, and press the **OK**.
4. Press the **←** to return to the previous menu.

12.11.3 Clearing Application Data

You can clear application data.

1. Select the application whose data you want to delete from **All Apps** menu and press the **OK**.
⇒ All applications are displayed.

2. Select **Clear the Data** and press the **OK**.
3. Select **OK** to confirm the operation or select **Cancel** to cancel it, and press the **OK**.
4. Press **←** to return to the previous menu.

12.11.4 Clearing the Application Cache

Clear application cache.

1. Select the application whose cache data you want to delete from **All Apps** menu and press the **OK**.
⇒ Application details are displayed.
2. Select **Clear the Cache** and press the **OK**.
3. Select **OK** to confirm the operation or select **Cancel** to cancel it, and press the **OK**.
4. Press **←** to return to the previous menu.

12.11.5 Application Default Settings

Delete the default preferences of the applications.

1. Select the application whose default settings you want to delete from **All Apps** menu and press the **OK**.
⇒ Application details are displayed.
2. Select **Clear defaults** and press the **OK**.
3. Select **OK** to confirm the operation or select **Cancel** to cancel it, and press the **OK**.
4. Press **←** to return to the previous menu.

12.11.6 App Notifications

Turn application notifications off and on.

1. Select the application whose notification preference you want to set from **All Apps** menu and press **OK**.
⇒ Application details are displayed.

2. Select **Notification** and use **OK** to select **On** or **Off**.
3. Press **←** to return to the previous menu.

12.11.7 Managing Application Updates

1. Select **Manage Updates** from the applications menu and press the **OK**.
⇒ **Manage Updates** menu will be displayed.
2. For automatically updating the applications when a new update is released, select **Auto-update apps** and use **OK** to select **On**.
3. To see the existing updates, select **See available updates** and press **OK**.

12.11.8 App Permissions

Edit application permissions.

1. Select **App Permissions** from the applications menu and press the **OK**.
⇒ Application permissions menu will be displayed.
2. Select the application permission type you want to edit and press the **OK**.
3. Select the application permission you want to edit and use the **OK** to select **On** or **Off**.
4. Press **←** to return to the previous menu.

12.11.9 Special Application Access

Edit application access.

1. Select **Special application access** from the applications menu and press the **OK**.
⇒ Special application access menu will be displayed.
2. Select the special application access type you want to edit and press the **OK**.
3. Select the special application access you want to edit and use the **OK** to select **On** or **Off**.

4. Press **←** to return to the previous menu.

12.11.10 Application Security and Restrictions

1. Select **Security** option from the applications menu and press the **OK**.
⇒ Security menu will be displayed.
2. Select **Scan apps with Play Protect** or **Improve harmful app detection** and use **OK** to select **On** or **Off**.
3. Press **←** to return to the previous menu.







13 Google Cast™

Your TV has built-in Google Cast feature. You can instantly switch from your phone, tablet or laptop to TV. With the built-in Google Cast feature, you can cast all your favourite movies, TV shows, applications, games and more directly to your TV. Google Cast runs on Android and iOS. Your mobile device or computer must be connected to the same Wi-Fi home network as your TV.



For more information; visit www.support.google.com/googletv.

13.1 Turning TV on with Google Cast

When the TV is in stand-by mode, you can send content to the TV via Google Cast and turn the TV on.

1. From the **Home Screen** menu, press  and then .
2. Select **System** option  and press.
3. Select **Power & Energy** and press the .
4. Select **Energy Modes** and press the .
⇒ **Energy Modes** menu will be displayed.
5. Select energy mode **Optimized** or select **Increased**.
⇒ **Optimized**: Enables Google Cast only for WiFi connection.
⇒ **Increased**: Enables Google Cast both for WiFi connection and cable network connection.
6. Select **Confirm** to confirm enabling or select **Cancel** to cancel it, and press the .

Note:

- When energy mode is selected as **Optimized** or **Increased**, your TV's energy consumption might increase.
7. Press  to return to the previous menu or press  to return to Home menu.

13.2 Using Google Cast on Android or iOS Mobile Device

You may cast photos, videos or games using an application with the Google Cast feature or from an iOS mobile device to your TV.

Notes:

- Google TV and your mobile device should have the latest version of Google Cast application installed.
 - Google Cast function works on Android 2.3 and above for Android devices and on iOS versions 7.0 and above for Apple iOS devices.
 - Broadcasting from Google Chrome browser is not supported on mobile devices.
1. The TV and the mobile device shall be connected to the same network.
 2. Start the application featuring Google Cast from the mobile device.
 3. Press  on the application screen.



4. Select TV from the list to start playback.
⇒ The content starts to be played on the TV screen.



13.3 Casting the Chrome Browser Tab on your TV via PC

You can display Chrome tab or your PC screen on your TV via Google Cast.



You can cast most web content, but some plugins may not work.

Notes:



- To use the Google Cast feature on PC without any problem, you shall be using the latest version of the Chrome browser on PC.
- Your computer shall be connected to the same Wi-Fi home network as your TV set.

1. Open the Chrome browser on your computer.
2. Click the  item on the upper right corner of the browser.
3. Click **Save and Share**.
4. Click **Cast**
 - ⇒ On **Cast** tab, the devices that are on the same network, supporting Google Castü are displayed.
5. Select your TV and cast chrome browser tab on your TV.
6. To end broadcasting, click the  icon located to the right of the browser's address bar and select **Stop Broadcast**.





13.4 Casting Computer Screen on TV

1. Open the Chrome browser on your computer.
2. Click the  item on the upper right corner of the browser.
3. Click **Save and Share**.
4. Click **Cast**.
 - ⇒ **Cast** tab will be displayed.
5. From **Sources**, click **Cast Screen**.
 - ⇒ On **Cast Screen** tab, the devices that are on the same network, supporting Google Castü are displayed.
6. Select your TV and cast your PC screen on your TV.
7. To end broadcasting, click the  icon located to the right of the browser's address bar and select **Stop Broadcast**.

13.5 Casting Music or Video Files from the Computer to the TV

1. Open the Chrome browser on your computer.
2. Open the file you want to broadcast on Chrome tab.
3. Drag and drop the file onto the Chrome tab or use the keyboard shortcut:
 - ⇒ Windows: Ctrl + O
 - ⇒ Mac: Command + O
4. Click the  item on the upper right corner of the browser.
5. Click **Save and Share**.
6. Click **Cast**
 - ⇒ On **Cast** tab, the devices that are on the same network, supporting Google Castü are displayed.
7. Select your TV and cast chrome browser tab on your TV.
8. To end broadcasting, click the  icon located to the right of the browser's address bar and select **Stop Broadcast**.

14 System Settings

1. From **Home Screen** menu, press .
2.  select **Settings** and press the .
3. Use the  to select **System** and confirm with the .

⇒ **System** menu will be displayed.

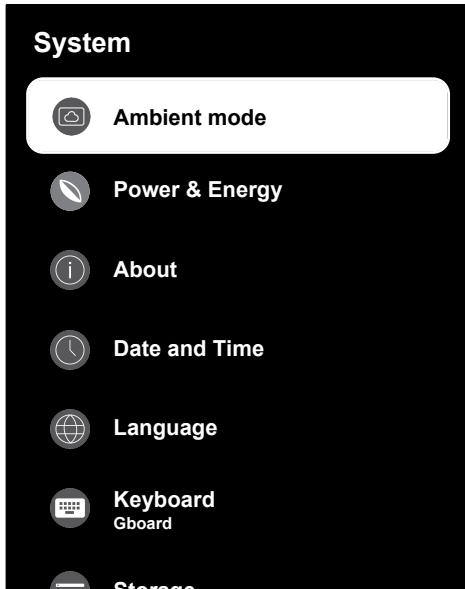







Note:

- Additional operations are explained in the following sections.

14.1 Ambience mode

Google TV Ambience Mode can turn your empty screen into a series of photos to lighten up your space when your TV is not in use. View your personal photos or choose between Art Gallery and Experimental.

1. From the **System** menu, select **Ambient mode** and press the .
- ⇒ **Ambient mode** menu will be displayed.
2. Select the desired line/function with the , , and select the value/option with ,  or .

3. Press the  to return to the previous menu.



14.2 Power and Energy

1. From the **System** menu, select **Power & Energy** and press the .

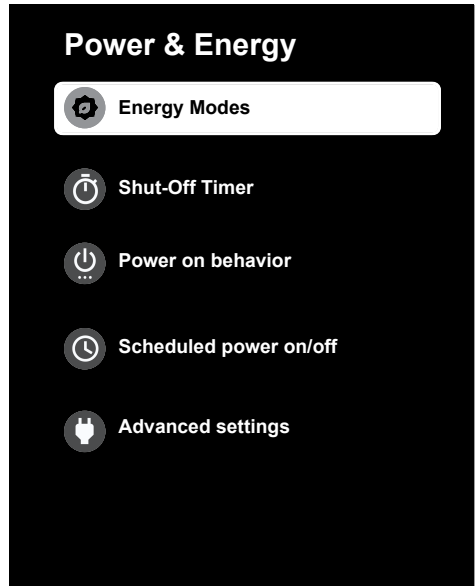
⇒ **Power & Energy** menu will be displayed.



14.2.1 Energy Modes



1. From the **Power & Energy** menu, select **Energy Modes** and press the .
- ⇒ **Energy Modes** menu will be displayed.
2. Select **Low**, **Optimized** or **Increased** and press .
3. Press the  to return to the previous menu.

14.2.2 Off Timer

1. From the **Power & Energy** menu, select **Shut-Off Timer** and press the .
- ⇒ **Shut-Off Timer** menu will be displayed.

2. Select **When inactive** or **After turning on** and select the turn-off time.
3. Press the  to return to the previous menu.



14.2.3 Power on Behavior

1. From the **Power & Energy** menu, select **Power on behavior** and press the .
 - ⇒ **Power on behavior** menu will be displayed.
2. Select **Google TV home screen** or **Last used input** and press .
3. Press the  to return to the previous menu.





14.2.4 Scheduled Power On / Off

You can manage Timer settings in this menu.



14.2.4.1 Auto On Timer

1. **Scheduled power on/off** From the menu **Power On Time Type** select and press the .
2. Select **On** or **Once** and press the .
 - ⇒ **On** : TV is turned on every day at the time entered.
 - ⇒ **Once** : TV is turned on once at the time entered, it does not repeat again.





Note:

- It is active in the menu when **Auto Power on Time, Power On Time Type On** or **Once** is selected.
3. Select **Auto Power on Time** and press the .
 4. Select the value with the , and the next option with the , and select hours and minutes respectively, and press the .
 5. Press the  to return to the previous menu.

14.2.4.2 Automatic Off Timer

1. From the **Scheduled power on/off** menu, select **Power Off Time Type** and press the .
2. Select **On** or **Once** and press the .
 - ⇒ **On**: TV is turned off every day at the time entered.
 - ⇒ **Once**: TV is turned off once at the time entered, it does not repeat again.





Note:

- It is active in the menu when **Auto Power off Time, Off Time Type** are selected as **On** or **Once**.
3. Select **Auto Power off Time** option, and press the .
 4. Select the value with the , and the next option with the , and select hours and minutes respectively, and press the .
 5. Press the  to return to the previous menu.

14.2.5 Advanced Settings

You can manage power settings in this menu. For the settings, refer to Power Settings section.

14.2.5.1 Power LED Brightness

1. From the **Power & Energy** menu, select **Power LED Brightness** and press the .
2. Select **High, Medium** or **Low** and press the .
3. Press the  to return to the previous menu or  to return to Home menu.

14.3 About

In this menu, you can check system updates, change the device name, and view the status and license information of the device.

1. From the **System** menu, select **About** and press the **OK**.
⇒ **About** menu will be displayed.

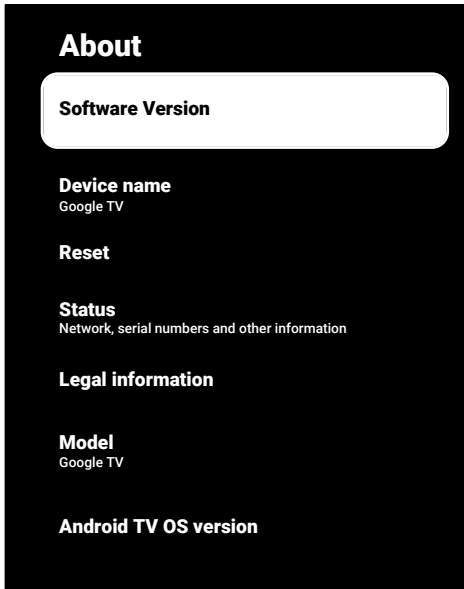

14.3.1 System update

1. From the **About** menu, select **Software Version** and press the **OK**.
⇒ System updates are checked. If there is a system update, after your approval, the update will be downloaded and your device will be updated.
2. Press the **←** to return to the previous menu.

14.3.2 Change Device Name

1. From the **About** menu, select **Device name** and press the **OK**.
2. Select **Replace** to change the device name or select **Replacement** to cancel the operation, and press the **OK**.
3. You can use one of the suggested device names or select **Enter Custom Name...** and press the **OK** to give the TV set a desired name.

4. Press the **←** to return to the previous menu.

14.3.3 Factory Reset

This process will delete all of the data in your device's internal storage. The data to be deleted are Google account, system and application data, as well as their settings and downloaded applications.

1. From the **About** menu, select **Reset** and press the **OK**.
2. Select **Factory reset** option, and press the **OK**.
⇒ A warning screen will be displayed.
3. Select **Factory reset** to confirm the reset or select **Cancel** to cancel it, and press the **OK**.
⇒ Second warning screen is displayed.
4. Select **Delete all** to confirm the reset or select **Cancel** to cancel it, and press the **OK**.
5. Continue with the Initial Set-up and Setting the TV set section.

14.3.4 Viewing Status Information

In this menu, you can view the device's IP address, MAC addresses and serial number.

1. From the **About** menu, select **Status** and press the **OK**.
⇒ **IP adresi**, **MAC adresi**, **Seri numarasi** and **Up time** will be displayed.
2. Press the **←** to return to the previous menu.

14.3.5 Viewing Legal Information

In this menu, you can view Open source licenses, Google's legal disclaimer, System web view licenses and notifications about Ads.

1. From the **About** menu, select **Legal information** and press the **OK**.

- Use the ▲/▼ to select the information you want to view and press the **OK**.
 - ⇒ The selected information will be displayed.
- Press the ◀ to return to the previous menu.

14.3.6 Viewing Other Information

- From the **About** menu, view **Model, Edition, Software Version, Netflix ESN, Android security patch level, Core version** and **Structure** information.
- Press the ◀ to return to the previous menu.

14.4 Date and Time Settings

You can view and manage system date and time information in this menu.

- From the **System** menu, select **Date and Time** and confirm with the **OK**.
 - ⇒ **Date and Time** menu will be displayed.

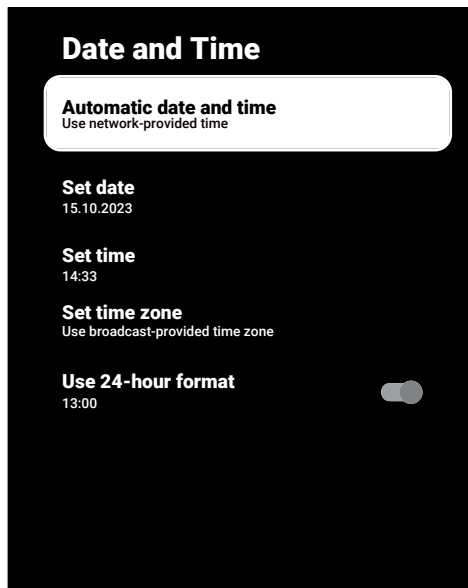

14.4.1 Automatic Date and Time Setting

It is the date and time information provided by the network.

- From the **Date and Time** menu, select **Automatic date and time** and press the **OK**.
- Select **Use network-provided time** option, and press the **OK**.

Note:

- When the time information provided by the network is used, **Date and Time** menu items **Set date** and **Set time** are not active.
- Press the ◀ to return to the previous menu.

14.4.2 Manual Date and Time Setting



- From the **Date and Time** menu, select **Automatic date and time** and press the **OK**.
- Select **Off** option, and press the **OK**.
- Select **Set date** option, and press the **OK**.
- Select the value with the ▲/▼, and the next option with the ►, and select day, month and year, respectively, and press the **OK**.
- Select **Set time** option, and press the **OK**.
- Select the value with the ▲/▼, and the next option with the ►, and select hours and minutes respectively, and press the **OK**.
- Press the ◀ to return to the previous menu.

14.4.3 Setting Time Zone

- From the **Date and Time** menu, select **Set time zone** and press the **OK**.
- Select your time zone with the ▲/▼ and press the **OK**.

3. Press the  to return to the previous menu.

14.4.4 Setting Time Format





1. From the **Date and Time** menu, select **Use 24-hour format** and use the  to select **On** for 24 hours format and **Off** for 12 hours format.
2. Press the  to return to the previous menu.

14.5 Language Settings

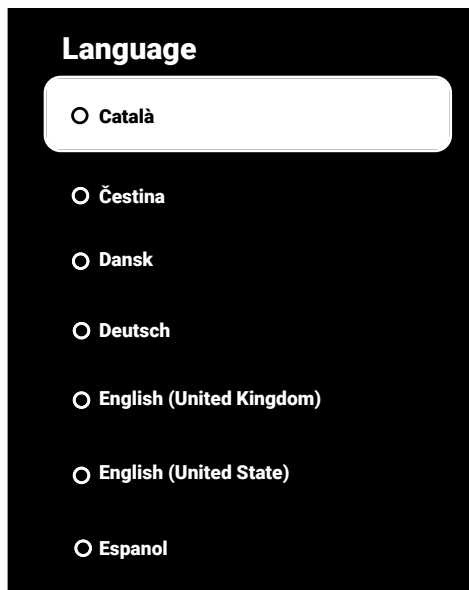
You can manage the TV language settings in this menu.

1. From the **System** menu, select **Language** and confirm with the .
– **Language** menu will be displayed.



2. Use the / to select the language and confirm with the .
3. Press  to return to the previous menu or press  to return to Home menu.



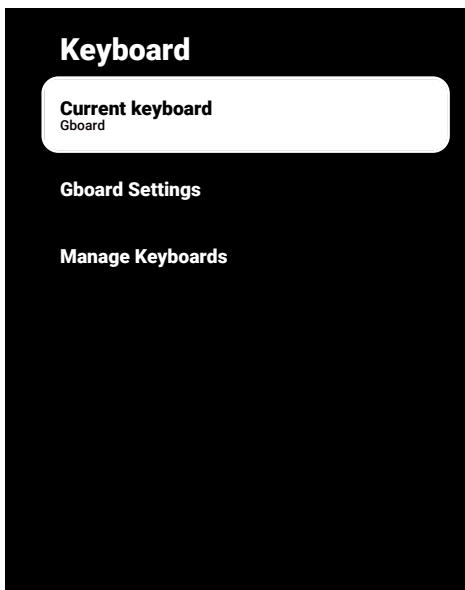

14.6 Keyboard Settings

You can manage the virtual keyboard settings in this menu.

1. From the **System** menu, select **Keyboard** and press the .
⇒ **Keyboard** menu will be displayed.



14.6.1 Available Keyboard Settings

1. From the **Keyboard** menu, select **Current keyboard** and press the .
2. Use the / to change keyboard selection and press .

Note:

- To change current keyboard, a 3rd party keyboard application shall be Google downloaded from Play Store.
3. Press the  to return to the previous menu.

14.6.2 Gboard Settings

Gboard keyboard is the built-in keyboard of the TV, you can adjust its settings in this menu.

1. From the **Keyboard** menu, select **Gboard Settings** and press the .

2. With the ▲/▼, you can change the Keyboard language, view the Terms of Service, Privacy Policy, Open source licenses or share Usage statistics.
3. Press the ⬅️ to return to the previous menu.

14.6.3 Manage Keyboards

1. From the **Keyboard** menu, select **Manage Keyboards** and press the **OK**.
 - ⇒ Available virtual keyboards will be displayed.
2. Select the Keyboard and use the **OK** to select **On** or **Off**.
3. Press ⬅️ to return to the previous menu or press 🏠 to return to Home menu.

14.7 Storage Settings

You can manage storage settings in this menu.

1. From the **System** menu, select **Storage** and press the **OK**.
 - ⇒ **Storage** menu will be displayed.

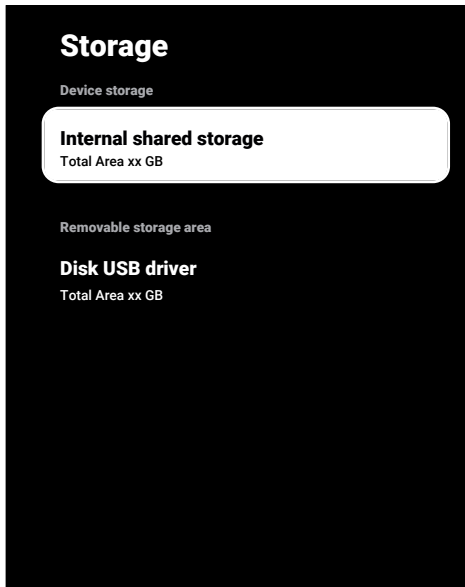

14.7.1 Internal Storage Area

1. From the **Storage** menu, select **Internal shared storage** and press the **OK**.
2. With the ▲/▼, view the internal storage area usage categories.
3. Press the ⬅️ to return to the previous menu.

14.7.2 Removable Storage Area

Note:

- Removable storage is only displayed on the menu when an external data medium is plugged into the TV.
1. From the **Storage** menu, select the external data media under the **Removable storage area** and press the **OK**.
 2. With the ▲/▼, view the external storage area usage categories and remove any unnecessary files.
 3. Press the ⬅️ to return to the previous menu.

14.7.3 Using Removable Storage Area As Internal Storage Area

You can set up an external data medium as device storage so that you can install applications that you will download for the device to this storage.

1. From the **Storage** menu, select the external data media under the **Removable storage area** and press the **OK**.
2. Select **Delete and format as storage area** option, and press the **OK**.
3. Select **Format** to format external data medium or select **Cancel** to cancel without formatting, and press the **OK**.

Important:

- This action will delete all data on the external data medium.
- After formatting, the external data medium can only be used in this device.

4. After formatting is complete, select **Move Now** and the **OK** to move all data to the external data medium.
⇒ Your data is moved to external data media.
5. Press the **←** to return to the previous menu.

14.8 Streaming

Allow other devices to control your streamed media. A notification is displayed on all Android devices connected to your wireless network and let them control the media streamed to this device.

1. From the **System** menu, select **Cast** and press the **OK**.
⇒ **Cast** menu will be displayed.
2. Select **While casting** or **Never** and press the **OK** button.
3. Press the **←** to return to the previous menu.

14.9 System Sounds

You can turn system sounds on or off.





1. From **System** menu, select **System sounds** and use **OK** to select **On** or **Off**.

14.10 Restart

1. From the **System** menu, select **Restart** and press the **OK**.
2. Select **Restart** to restart the appliance or select **Cancel** to cancel it, and press the **OK**.
3. The television will restart.

15 Privacy Settings

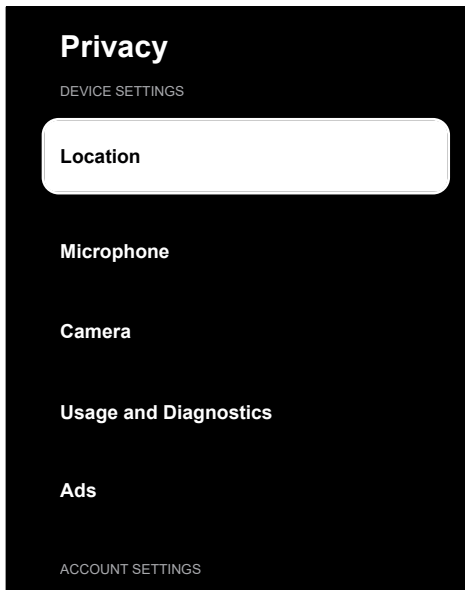

Manage your device, account and application privacy settings from this menu.

1. From **Home Screen** menu, press .
 2. Select  **Settings** and press .
 3. Select **Privacy** and press the .
- ⇒ **Privacy** menu will be displayed.





15.1 Location Settings

You can manage device location settings in this menu.

1. From the **Privacy** menu, select **Location** and press the .
- ⇒ **Location** menu will be displayed.
2. Select **Location status** option, and press the .
 3. Select **Use Wi-Fi to estimate location** to turn the location service on or select **Off** to turn the location services off, and press the .





4. To allow Google location services and other applications to scan the networks when wireless is off, select **Scan always available** and use  to select **On** setting.

Note:

- You can also view the applications that have made last location requests in the menu, and you can turn off the location service of the application from the application settings by selecting the application.
5. Press  to return to the previous menu or press  to return to Home menu.



15.2 Microphone

You can manage device microphone settings in this menu.

1. From the **Privacy** menu, select **Microphone** and press the .
- ⇒ **Microphone** menu will be displayed.
2. Select **Microphone access** and use  to select **On** or **Off**.
 3. Select **App access to microphone** and press the .
- ⇒ **Microphone permissions** menu will be displayed.
4. Use the menu to select application or services and edit microphone access options.
 5. Press  to return to the previous menu or press  to return to Home menu.

15.3 Camera

You can manage device microphone settings in this menu.

1. From the **Privacy** menu, select **Camera** and press the .
- ⇒ **Camera** menu will be displayed.
2. Select **Camera access** and use  to select **On** or **Off**.

3. Select **App access to camera** and press the **OK**.
- ⇒ **Camera permissions** menu will be displayed.
4. Use the menu to select application or services and edit microphone access options.
5. Press **←** to return to the previous menu or press **⬆** to return to Home menu.

15.4 Usage and Diagnostic settings

You can have diagnostic data such as deadlock reports, device, application, and built-in chromecast data automatically sent to Google.

1. From the **Privacy** menu, select **Usage and Diagnostics** and press the **OK**.
- ⇒ **Usage and Diagnostics** menu will be displayed.
2. Select **On** if you want that Usage and Diagnostics data are sent automatically or select **Off** if you want these data are not sent, and press the **OK**.
3. Press the **←** to return to the previous menu.

15.5 Ads

1. From the **Privacy** menu, select **Ads** and press the **OK**.
- ⇒ **Ads** menu will be displayed.

15.5.1 Reset Ad ID

1. From the **Ads** menu, select **Reset Ad ID** and press the **OK**.
2. Select **OK** to reset ad ID or select **Cancel** to cancel the operation, and press the **OK**.
3. Press the **←** to return to the previous menu.

15.5.2 Delete Ad ID

1. From the **Ads** menu, select **Delete advertising ID** and press the **OK**.
2. Select **OK** to reset ad ID or select **Cancel** to cancel the operation, and press the **OK**.
3. Press the **←** to return to the previous menu.

15.6 Google Assistant Settings

You can manage Google Assistant settings in this menu.

1. From the **Privacy** menu, select **Google Assistant** and press the **OK**.
- ⇒ **Google Assistant** menu will be displayed.

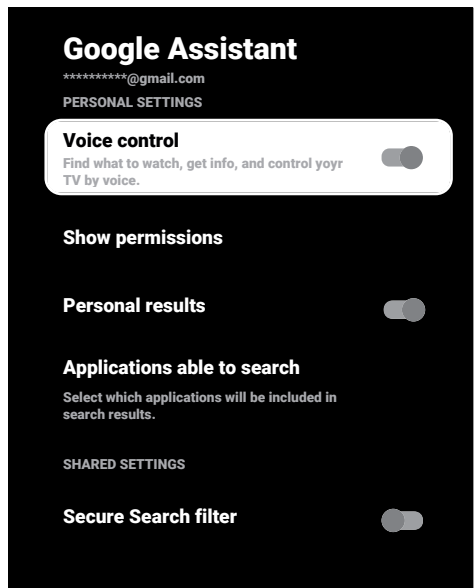

2. With the **▲/▼**, view the connected account, perform searches, organize applications, activate the safe search filter, and view open source licenses.
3. Press the **←** to return to the previous menu.

15.7 Payment and Purchasing Transactions

You can manage your purchasing transactions of your Google account from this menu.

1. From the **Privacy** menu, select **Payment & Purchases** and press the **OK**.
⇒ **Payment & Purchases** menu will be displayed.

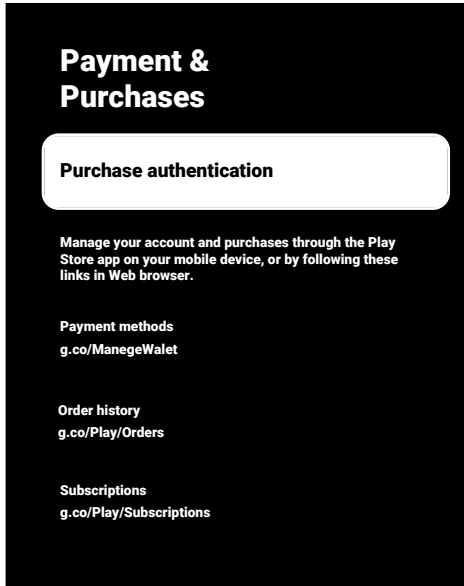

2. Select **Purchase authentication** option, and press the **OK**.
3. Select **Yes, whit PIN, Yes, with password** or **Never** and press the **OK**.
4. Press the **←** to return to the previous menu.

15.8 Application Settings

You can manage application permissions, special application access, safety and limitations settings from this menu.











For application settings, refer to Application Settings [▶ 66] section.

16 Remote Controls and Accessories





You can connect various accessories to your television, e.g. Bluetooth remote controller, game controller, keyboard or mouse. You can view the status of the connected accessories in this menu to make adjustments.







Accessories are supplied separately. They are not delivered with the TV set. Please contact your dealer from where you have purchased your TV in order to obtain more information for buying glasses.

1. From **Home Screen** menu, press .
2.  select **Settings** and press the .
3. Use the  to select **Remote Controls and Accessories** and press the 
⇒ **Remote Controls and Accessories** menu will be displayed.
4. Select **Pair accessory** and press the .
5. Accessories found will be displayed in the menu.
6. Select the accessory you want to pair with the / and confirm with the .
7. Press  to return to the previous menu or press  to return to Home menu.

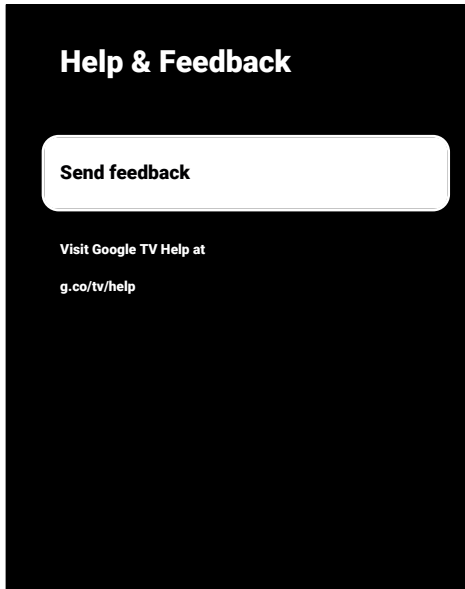
17 Help and Feedback

1. From **Home Screen** menu, press .
 2. Select  **Settings** and press .
 3. Use the  to select **Help & Feedback** and press the .
- ⇒ **Help & Feedback** menu will be displayed.



4. Select **Send feedback** option, and press .
5. Write a message from the screen keyboard, select  symbol and press .
6. Select **Send feedback** to send the notification or select **Cancel** to cancel the operation, and press the .

18 Using an External Device

18.1 CEC (Consumer Electronics Control)

Your TV has CEC (Consumer Electronics Control) feature. This feature utilizes CEC (Consumer Electronics Control) protocol. CEC allows you to make an HDMI connection between your TV and DVD player, STB or video recorder and control such equipment with the remote control of the television. This feature must be supported by the device you connect as well.

Your television supports the following functions. For detailed information about this feature, read the user manual of the external device.

18.1.1 Switching the External Device On from the Standby Mode

If you switch your external device (e.g. DVD player) on from standby mode, your television will also be switched on from standby and switched to the HDMI source that your television is connected to.

Depending on the features of the external device (e.g. AV receiver), it may be turned on and your television may remain in standby mode.

18.1.2 Selecting the HDMI Source

When you switch on your external device (e.g. DVD player), your television will switch to the HDMI source that the external device is connected to. (Your television must be on).

18.1.3 Selecting the Menu Language















When you select the menu language of the television, the menu of the external device will change, too. (If the External Device supports it).

18.1.4 Switching the External Device to Standby Mode

After switching your television to standby, your external device will also switch to standby if it is on.

For detailed information about this feature, read the user manual of the external device.

18.1.5 Enabling the Control of a HDMI CEC Device

1. From **Home Screen** menu, press .
2. Use the / / /  to select  **Settings** and press the .
3. Select **Channels & Inputs**'s option  and press.
4. Select **Inputs** option, and press the .
5. Select **Global CEC control** and select **On** by pressing the .
6. When the source, to which the external device is connected while CEC is active is selected, CEC functions are enabled.
7. If you want to turn the CEC supported device off together with the TV, select **Allow TV to turn off connected devices** and select **On** by pressing the .
8. If you want to turn the TV set on when you turn the CEC supported device on, select **Allow connected devices to turn on/off TV** and select **On** by pressing the .
9. Press  to return to the previous menu or press  to return to Home menu.

18.2 Connection Options

Your television can play high-definition television signals (HDTV).

You can connect the input sources (HDTV settop box or High Definition DVD player) to the **HDMI** socket (digital HDTV signal).

This ensures that you can view digital HDTV programmes, even if they are copy-protected (HDCP High Bandwidth Digital Content Protection).

- Which television socket(s) you connect your external devices to depends on the sockets the external device is equipped with and the signals which are available.

- Note that with many external devices the resolution of the video signal must be to the input sockets on the television (check the external device's instruction manual). You can find out which values you need to set by referring to the guidelines in the section about connection options.
- Do not connect any other equipment while the device is switched on. Switch off the other equipment as well before connecting it.
- Only plug the device into the mains socket after you have connected the external device.

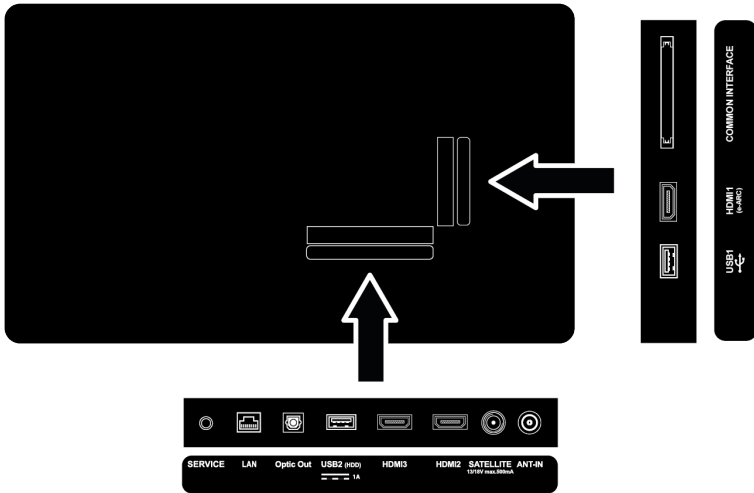



18.3 Connecting an External Device with Digital Audio and Image Signal

- **Suitable devices:** Digital satellite receiver, game console, BluRay player, DVD player/recorder, set-top box, notebook, PC.
- **Video signal:** Digital image
- **Audio signal:** Digital audio (stereo, multichannel compression, uncompressed).

- **Channel Position: HDMI1, HDMI2, HDMI3**

1. Connect the **HDMI1, HDMI2, HDMI3** socket on the television and the corresponding HDMI socket on the external device using a standard HDMI cable (digital video and audio signal).









18.4 Using a DVD Recorder, DVD Player or Video Recorder

1. Switch on the DVD recorder, DVD player or video recorder and select the function you wish to use.
2. Press the  on the remote, select the signal source and press the .
3. Select **HDMI1**, **HDMI2** or **HDMI3** as source and press the .

18.5 Connecting Digital Multi-Channel Amplifier/AV Receiver

1. Connect the **HDMI1 (e-ARC)** socket on the TV set to the relevant socket on the HDMI e-ARC / ARC compliant Digital multichannel amplifier / AV receiver using a standard HDMI cable or connect the **Optic Out** socket on the TV set to the relevant socket on the AV receiver using a standard optic digital cable.

Important:

- Do not use a HDMI cable longer than 5 m for HDMI e-ARC/ARC connection.
2. From **Home Screen** menu, press .
 3.  select **Settings** and press the .
 4. Select **Display & Sound** option, and press .
 5. Select **Sound** option, and press the .
 6. Select **eARC** and use /  to select **Auto**.
 7. Press  to return to the previous menu or press  to return to Home menu.

18.6 CY (Common Interface)

18.6.1 What is Common Interface?

- Common interface (CI) is an interface used in DVB receivers.
- Scrambled channels can only be viewed with a CA module suitable for the encoding system and the corresponding smart card.

- Your television is equipped with a Common interface slot into which CA modules from various providers can be inserted.
- You can insert the provider's smart card into the CA module in order to enable the encrypted stations you want to see.
- Your TV supports CI+1.4.

18.6.2 Inserting the CA module

Important:

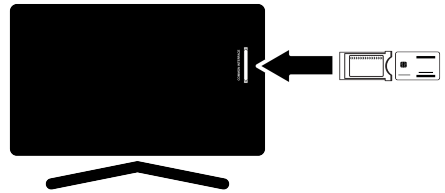

- Switch off the appliance before inserting the CA module in the COMMON INTERFACE slot.
1. Insert the smart card into the CA module.
 2. Insert the CA module with the smart card into the COMMON INTERFACE slot on the television.





Notes:

- To see which CA module is present in the Common slot, go to the CA - Module sub-menu.
- When you insert a CA module into the CI slot on the television for the first time, wait a few moments until the television has registered the CA module.

18.6.3 Access Control for CA Module and Smart Cards

1. Press  in the TV mode.
 2. Use the  to select **CI Card** and press the .
- ⇒ CA Information menu will be displayed.

Notes:

- This menu give operating instructions and – after you enter your PIN code – access to channels of the PAY-TV provider.
 - Other settings are described in the manuals for your CA module and smart card.
 - The CA module is not supported in some countries and regions. Please consult your authorised dealer.
3. Press  to return to the previous menu or press  to return to Home menu.

19 Network Setup

You need wired or wireless internet connection to use features of Google TV.

- You can establish a wired or wireless connection between your television and the local network.
- If you want to use a wired network connection, please start with the instructions here.
- If you use a wireless network connection, please follow the instructions in the "Wireless network connection" section.

Note:

- The following section describes connecting to the home network if you did not carry this out during the "Initial Set-up".

19.1 Wired Network Connection

Connect the output of modem to the **LAN** socket with a Cat 5 cable.

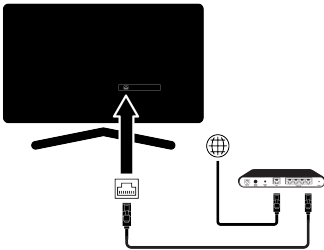

Note:

- Connection cables are not supplied.

19.2 Wired Network Settings

There are two ways of making the wired network settings.

1. **Automatic Connection** : all data regarding connection settings (**IP Address**, **Netmask**, **Gateway** and **DNS**) are obtained from modem automatically.
2. **Manual Connection** : all data regarding connection settings (**IP Address**, **Netmask**, **Gateway** and **DNS**) must be configured manually.

19.2.1 Automatic Connection















Most home networks are Dynamic Networks. If you have a dynamic network, you must use a DSL modem that supports DHCP. Modems and IP sharers supporting DHCP receive **IP Address**, **Netmask**, **Gateway** and **DNS** values required for internet access, thus your TV set connects to the network automatically.

Note:

- If you do not have a dynamic network, follow the instructions in manual connection section.

19.2.2 Manual Connection

Certain networks require Static IP address. If your network requires a Static IP address, you need to enter **IP Address**, **Netmask**, **Gateway** and **DNS** values manually. You can learn the **IP Address**, **Netmask**, **Gateway** and **DNS** values from your Internet Service Provider (ISP).

1. From **Home Screen** menu, press .
2.  select **Settings** and press the .
3. Select **Network and Internet** option, and press .
4. Select **IP Settings** and press the .
5. Select **Static** and press the .
6. Enter **IP Address** and select the  key from the screen keyboard and press the .
7. Enter **Gateway** and select the  key from the screen keyboard and press the .
8. Enter **Network prefix length** and select the  key from the screen keyboard and press the .
9. If applicable, enter the value of **DNS1** and select the  key from the screen keyboard and press the .

10. If applicable, enter the value of **DNS2** and select the **→** key from the screen keyboard and press the **OK**.
11. **Successfully saved!** message will be displayed.
12. Press **←** to return to the previous menu or press **h** to return to Home menu.

19.3 Wireless Network Connection

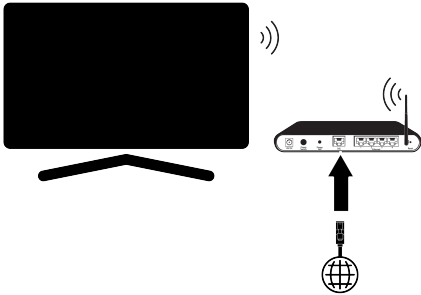

- Your TV set is equipped with a built-in Wireless Wi-Fi Adapter to connect it to wireless network.
- Wireless LAN adapter supports IEEE 802.11B/G and N communication protocols. We recommend you to use IEEE 802.11N protocol to obtain the best performance in HD video playback over wireless connection.
- If you use a modem that supports IEEE 802.11B/G, video playback performance may be poor when compared to a modem that supports IEEE 802.11N since the data transfer rate of IEEE 802.11B/G protocol is lower.
- It is recommended to switch off the equipment that are not in use in home network in order to avoid unnecessary network traffic.
- Placing the modem or wireless network sharer on an elevated location will increase the wireless connection reception strength.

- Wireless connection reception strength may vary depending on the type of the modem and the distance between the modem and television.

19.4 Wireless Network Settings

There are two ways for making the wireless network settings.

1. **Automatic Connection** : all data regarding connection settings (**IP Address, Netmask, Gateway** and **DNS**) are obtained from modem automatically.
2. **Manual Connection** : all data regarding connection settings (**IP Address, Netmask, Gateway** and **DNS**) must be configured manually.

19.4.1 Technical Requirements

Most home networks are Dynamic Networks. If you have a dynamic network, you must use a DSL modem that supports DHCP. Modems and IP sharers supporting DHCP receive **IP Address, Netmask, Gateway** and **DNS** values required for internet access, thus your TV set connects to the network automatically.

19.4.2 Auto Connection By Entering the Network Password

1. From **Home Screen** menu, press **⚙**.
2. **⚙** select **Settings** and press the **OK**.
3. Select **Network and Internet** option, and press **OK**.
4. Select the network you want to connect and from the **Available networks** tab, select the network you want to connect to with the **▲/▼** and press the **OK**.
 - ⇒ Wireless connection password screen will be displayed.

Note:

- If your network is not displayed among available networks, select **Show All** and press the **OK**.

5. Use ◀/▶/▲/▼ to enter the password from the screen keyboard, select the → key and press the **OK**.
 - ⇒ Connection established successfully message will be displayed and modem connection shall be established.
6. Press ⬅ to return to the previous menu or press **h** to return to Home menu.

19.4.3 Connecting to a Hidden Wireless Network

You can connect to a network with a hidden SSID.

1. Press the **⊙** button on the home screen.
2. **⚙** select Settings and press the **OK**.
3. Select **Network and Internet** option, and press **OK**.
4. Select **Add New Network** and press the **OK**.
 - ⇒ SSID entry menu will be displayed.
5. Use ◀/▶/▲/▼ to enter the SSID from the screen keyboard, select the → key and press the **OK**.
 - ⇒ Password type selection menu will be displayed.
6. Select **N/A, WEP, WPA/WPA2 Personal** or **WPA3-Personal** as password type and press the **OK**.
 - ⇒ Password Entry menu will be displayed.
7. Use ◀/▶/▲/▼ to enter the password from the screen keyboard, select the → key and press the **OK**.
 - ⇒ Connection established successfully message will be displayed and modem connection shall be established.
8. Press ⬅ to return to the previous menu or press **h** to return to Home menu.

19.4.4 Manual Connection By Entering the Network Password

Certain networks require Static IP address. If your network requires a Static IP address, you need to enter **IP Address, Netmask, Gateway** and **DNS** values manually. You can learn the **IP Address, Netmask, Gateway** and **DNS** values from your Internet Service Provider (ISP).

1. From **Home Screen** menu, press **⊙**.
2. **⚙** select Settings and press the **OK**.
3. Select **Network and Internet** option, and press **OK**.
4. Select the network you want to connect and from the **Available networks** tab, select the network you want to connect to with the ▲/▼ and press the **OK**.
 - ⇒ Wireless connection password screen will be displayed.

Note:

- If your network is not displayed among available networks, select **Show All** and confirm with the **OK**.
5. Use ◀/▶/▲/▼ to enter the password from the screen keyboard, select the → key and press the **OK**.
 - ⇒ Connection established successfully message will be displayed and modem connection shall be established.
 6. Select the network you are connected to and press the **OK**.
 7. Select **IP Settings** and press the **OK**.
 8. Select **Static** and press the **OK**.
 9. Enter **IP Address** and select the → key from the screen keyboard and press the **OK**.
 10. Enter **Gateway** and select the → key from the screen keyboard and press the **OK**.

11. Enter **Network prefix length** and select the **→** key from the screen keyboard and press the **OK**.

12. If applicable, enter the value of **DNS1** and select the **→** key from the screen keyboard and press the **OK**.

13. If applicable, enter the value of **DNS2** and select the **→** key from the screen keyboard and press the **OK**.

⇒ **Successfully saved!** message will be displayed.

14. Press **←** to return to the previous menu or press **h** to return to Home menu.

19.4.5 Proxy Settings

1. From **Home Screen** menu, press **⊙**.

2. **⚙** select Settings and press the **OK**.

3. Select **Network and Internet** option, and press **OK**.

4. Select the network you want to connect and from the **Available networks** tab, select the network you want to connect to with the **▲/▼** and press the **OK**.

⇒ Wireless connection password screen will be displayed.

Note:

- If your network is not displayed among available networks, select **Show All** and confirm with the **OK**.

5. Use **←/→/▲/▼** to enter the password from the screen keyboard, select the **→** key and press the **OK**.

6. Connection established successfully message will be displayed and modem connection shall be established.

⇒ Select the network you are connected to and press the **OK**.

7. Select **Proxy settings** and press the **OK**.

8. Use the **▼** to select **Manual** and press the **OK**.

9. Use **←/→/▲/▼** to enter the Proxy main computer name from the screen keyboard, select the **→** and press the **OK**.

10. Use **←/→/▲/▼** to enter the Proxy main computer point from the screen keyboard, select the **→** and press the **OK**.

11. Use **←/→/▲/▼** to enter the excluded domain names, if any, from the screen keyboard, select the **→** and press the **OK**.

⇒ **Successfully saved!** message will be displayed.

12. Press **←** to return to the previous menu or press **h** to return to Home menu.

20 Detailed Channel Settings

20.1 Automatic Search for Digital Television Channels with Single Satellite Connection

New satellite channels are added or satellite data is changed frequently. Therefore, we recommend you to run auto scan function from time to time.

All transponders are scanned for new channels.



If there is a direct cable connection from your satellite antenna to the TV set, and if there is no common satellite antenna switchboard, you need to search over a single cable.

1. In TV mode, press the **OK**, select **Source** and press the **OK**.
2. Select **Satellite** and press the **OK**.
3. Press the **OK**, select **Settings** and press the **OK**.
4. Select **Channels & Inputs** option **OK** and press.
5. Select **Channels** option, and press the **OK**.
⇒ Channel menu will be displayed.
6. Select **Satellite** and press the **OK**.
7. Select **Channel Installation Mode** option, and press the **OK**.
8. Select **Satellite (Standard)** if you are using an operator, select **Satellite (Operator Mode)**, and press the **OK**.

Note:

- This setup has been described as **Satellite (Standard)**.
9. Select **Automatic Channel Scan** option, and press the **OK**.
⇒ A warning message will be displayed.

10. To delete all the previously scanned channels and scan again, select **OK**, and to cancel scanning, select **Cancel** and press **OK**.

⇒ **Satellite Antenna Type** menu will be displayed.

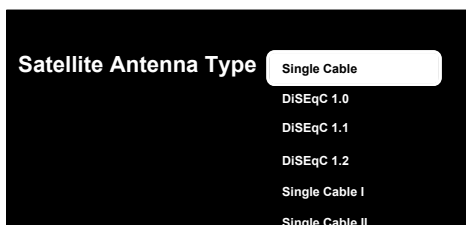

11. Select **Single Cable** and press the **OK**.
12. Select **Current Satellite** and press the **OK**.
13. Select **Satellite Selection** using the **OK** and use the **▲/▼** to select the satellite you wish to use for searching.
14. Select the **Scan Mode Network** or **Full**.
15. Select **Scan Type**.
⇒ Select **Free** for unencrypted channels only
⇒ Select **Encrypted Channels Only** for encrypted channels only
⇒ Select **All** for all satellite channels.
16. Select **Store Type**.
⇒ Select **Only Digital Channels** for TV channels only
⇒ Select **Only Radio Channels** for radio channels only
⇒ Select **All** for scanning both options.
17. Press the **◀** to return to the previous menu.
18. Select **Next** option and press the **OK**.
⇒ **Channel Scan** menu will be displayed.

19. Select **Scan** option, and press the **OK**.
 - ⇒ **Automatic Search** menu will be displayed and the search for TV stations shall start.
 - ⇒ Search may take several minutes depending on the number of television stations received.

Note:

- If some of the frequencies are not stored completely due the changes parameters satellite parameters made by the broadcaster, it is recommended to set the **Scan Mode** as **Network**.

20. Press the **←** to return to the previous menu or **⏠** to return to Home menu.

20.2 Manual Search for Digital Television Channels with Single Satellite Connection

If a certain channel cannot be found with automatic scan, scan it by manual scan. You must enter all parameters of the channel correctly. You can obtain the current transponder information from Teletext page, satellite TV magazines or internet.

i If there is a direct cable connection from your satellite antenna to the TV set, and if there is no common satellite antenna switchboard, you need to search over a single cable.

1. In TV mode, press the **⚙**, select **Source** and press the **OK**.
2. Select **Satellite** and press the **OK**.
3. Press the **⚙**, select **Settings** and press the **OK**.
4. Select **Channels & Inputs** option **OK** and press.
5. Select **Channels** option, and press the **OK**.
 - ⇒ Channel menu will be displayed.
6. Select **Satellite** and press the **OK**.

7. Select **Channel Installation Mode** option, and press the **OK**.
8. Select **Satellite (Standard)**, or select **Satellite (Operator Mode)** if you are using an operator and press **OK**.
9. Press the **←** to return to the previous menu.
10. Select **Satellite Manual Tuning** option, and press the **OK**.
11. Select **Current Satellite** and press the **OK**.
 - ⇒ **Transponder Settings** menu will be displayed.

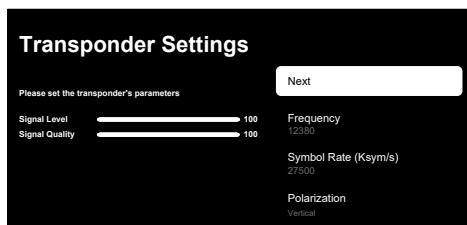

12. Press the **▲/▼** to select the required items and press the **OK** to confirm.
 - ⇒ **Frequency** - Enter the channel frequency in 5 digits with the **1...0**.
 - ⇒ **Symbol** - Enter the channel symbol rate in 5 digits with the **1...0**.
 - ⇒ Select **Polarization** - Channel **Horizontal or left, Vertical or right**.
13. Press the **←** to return to the previous menu.
14. Select **Next** option and press the **OK**.
 - ⇒ **Automatic Search** menu will be displayed and the search for TV stations shall start.
 - ⇒ Search may take several minutes depending on the number of television stations received.

15. After completing the settings, use **Satellite Selection** menu to select **Next** and press **OK**.

⇒ **Channel Scan** menu will be displayed.

16. Select **Scan** and press the **OK**.

⇒ TV channel scan will start.

⇒ Search may take several minutes depending on the number of television stations received.

17. Press the **←** to return to the previous menu or **h** to return to Home menu.

20.3 Antenna Settings for Digital Satellite Channels and Searching for Channels Automatically with DiSEqC 1.0/1.1

 **LNB settings described in the following section require significant expertise on satellite systems. Contact an expert about the subject.**

1. In TV mode, press the **⊗**, select **Source** and press the **OK**.

2. Select **Satellite** and press the **OK**.

3. Press the **⊗**, select **Settings** and press the **OK**.

4. Select **Channels & Inputs** option, and press **OK**.

5. Select **Channels** option, and press the **OK**.

⇒ Channel menu will be displayed.

6. Select **Satellite** and press the **OK**.

7. Select **Channel Installation Mode** option, and press the **OK**.

8. Select **Satellite (Standard)** if you are using an operator, select **Satellite (Operator Mode)**, and press the **OK**.

9. Select **Automatic Channel Scan** option, and press the **OK**.

⇒ A warning message will be displayed.

10. To delete all the previously scanned channels and scan again, select **OK**, and to cancel scanning, select **Cancel** and press **OK**.

⇒ **Satellite Antenna Type** menu will be displayed.

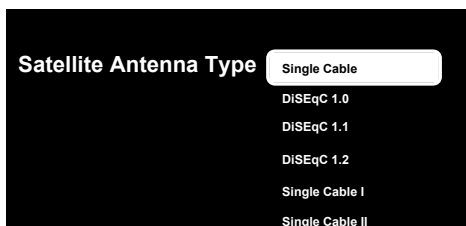

11. As per your current antenna type, select **DiSEqC 1.0** or **DiSEqC 1.1** and press the **OK**.

- **DiSEqC 1.0:** By using a satellite or switch, broadcasts can be received from up to four different satellites at the same time.

- **DiSEqC 1.1:** By using a satellite or switch, broadcasts can be received from up to sixteen different satellites at the same time.

12. Depending on your selection of **DiSEqC 1.0** or **DiSEqC 1.1**, 4 or 16 satellites will be displayed in the menu.

Note:

- Example setup is explained with 4 satellites as per **DiSEqC 1.0**.

13. Select a satellite from the **Satellite Selection** menu and press the **OK**.

14. Select **Satellite Status On** option and press the **OK**.

15. Select a satellite from the **Satellite Selection** menu and press the **OK**.

16. Select the **Scan Mode Network** or **Full**.

17. Select **Scan Type**.

- ⇒ Select **Free** for unencrypted channels only
- ⇒ Select **Encrypted Channels Only** for encrypted channels only
- ⇒ Select **All** for all satellite channels.

18. Select **Store Type**.

- ⇒ Select **Only Digital Channels** for TV channels only
- ⇒ Select **Only Radio Channels** for radio channels only
- ⇒ Select **All** for scanning both options.

19. Select **LNB Settings** and press the **OK**.

20. Select the required options with the ▲/▼.

- ⇒ **LNB Power**: Press **OK**, select LNB power and press **OK**.
- ⇒ **LNB Frequency**: Press **OK** and select LNB frequency used in the satellite system and press again the **OK**.

21. DiSEqC 1.0 Port: Press **OK**.

- ⇒ **DiSEqC 1.0 Port** menu will be displayed.

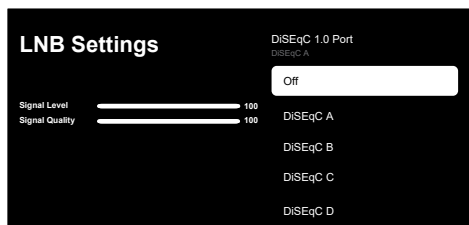

22. To select the satellite corresponding to the relevant DiSEqC positions in the satellite system, select **DiSEqC A**, **DiSEqC B**, **DiSEqC C** or **DiSEqC D**.

Note:

- If **Antenna Type**, **DiSEqC 1.1** is selected, make a selection between **DiSEqC:1** and **DiSEqC:16**.

23. Return to the **Automatic Channel Scan** menu by pressing the **←** twice.

Note:

- Make the settings described in steps **16** to **20** for other three satellites you want to scan.

24. After completing the settings, use **Satellite Selection** menu to select **Next** and press **OK**.

- ⇒ **Channel Scan** menu will be displayed.

25. Select **Scan** and press the **OK**.

- ⇒ TV channel scan will start.
- ⇒ Search may take several minutes depending on the number of television stations received.

26. Press the **←** to return to the previous menu or **⬇** to return to Home menu.

20.4 Antenna Settings for Digital Satellite Channels and Searching for Channels Automatically with the Single Channel Router (SCR) system

 Your TV supports SCR (Single Channel Router) system. SCR (Single Channel Router - EN 50494). LNB settings described in the following section require significant expertise on satellite systems. Contact an expert about the subject.

1. In TV mode, press the **⊙**, select **Source** and press the **OK**.
2. Select **Satellite** and press the **OK**.
3. Press the **⊙**, select **Settings** and press the **OK**.
4. Select **Channels & Inputs** option **OK** and press.
5. Select **Channels** option, and press the **OK**.
 - ⇒ **Channel** menu will be displayed.
6. Select **Satellite** and press the **OK**.

7. Select **Channel Installation Mode** option, and press the **OK**.
8. Select **Satellite (Standard)** if you are using an operator, select **Satellite (Operator Mode)**, and press the **OK**.
9. Select **Automatic Channel Scan** option, and press the **OK**.
 - ⇒ A warning message will be displayed.
10. To delete all the previously scanned channels and scan again, select **OK**, and to cancel scanning, select **Cancel** and press **OK**.
 - ⇒ **Satellite Antenna Type** menu will be displayed.

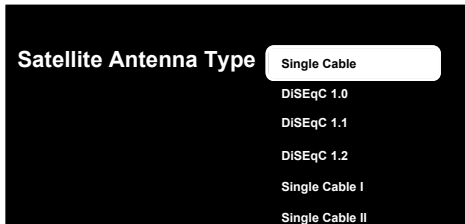

11. As per the type of the single cable router multiswitch on your antenna system, select **Single Cable I** or **Single Cable II** and press the **OK**.
 - **Single Cable I:** By using a single channel router, broadcasts can be received on up to eight different devices via the same cable.
 - **Single Cable II:** By using a single channel router, broadcasts can be received on up to thirty-two different devices via the same cable.
12. Depending on your selection of **Single Cable I** or **Single Cable II** 8 or 32 user bands will be displayed in the **Tuner** menu.

Note:

- Example setup is explained for eight devices with **Single Cable I**.

13. Select the required options with the **▲/▼**.
 - ⇒ **Tuner: User band 1** ile **User band 8** arasında seçim yapın.
 - ⇒ **Band Frequency:** Select the band frequency with the **▲/▼** button and press the **OK** button.
 - ⇒ **User Defined:** Determine the band frequency yourself. From the **Band Frequency** field, select **User Defined**. **User Defined** option will be displayed in the **Single Cable I** menu. Enter user defined frequency with the **1...0**.
14. Select **Next** option and press the **OK**.
 - ⇒ **Satellite Selection** menu will be displayed.
15. Select the first satellite displayed in the menu and press the **OK**.
16. Select **Satellite Status** as **On**.
17. Select **Satellite Selection** using the **OK** and select the satellite you wish to use for searching.
18. Select the **Scan Mode Network** or **Full**.
19. Select **Scan Type**.
 - ⇒ Select **Free** for unencrypted channels only
 - ⇒ Select **Encrypted Channels Only** for encrypted channels only
 - ⇒ Select **All** for all satellite channels.
20. Select **Store Type**.
 - ⇒ Select **Only Digital Channels** for TV channels only
 - ⇒ Select **Only Radio Channels** for radio channels only
 - ⇒ Select **All** for scanning both options.
21. Select **LNB Settings** and press the **OK**.

22. Select **Position** option, and press the **OK**.

- ⇒ Select the position corresponding to the satellite you want to search and press the **OK**.

23. Return to the **Satellite Selection** menu by pressing the **←** twice.

Note:

- Make the settings described in steps **15** to **24** for each satellite you want to scan.

24. Select **Next** option and press the **OK**.

25. **Channel Scan** menu will be displayed.

26. Select **Scan** option, and press the **OK**.

- ⇒ **Automatic Search** menu will be displayed and the search for TV stations shall start.
- ⇒ Search may take several minutes depending on the number of television stations received.

Notes:

- Use installation equipment supported / suggested by the SCR router.
- Other users / receivers connected to the system may be affected if the specified user band number and frequency are changed during installation.
- User band and User band frequency are specified on the SCR router used; and each user / receiver must select a specified user band and user band frequency.
- With SCR satellite system, auto search by several users / receivers at the same time may cause problems.

27. Press the **←** to return to the previous menu or **⏠** to return to Home menu.

20.5 Motorized Antenna Settings



LNB settings described in the following section require significant expertise on satellite systems. Contact an expert about the subject.

Your TV supports DiSEqC 1.2 motorized satellite systems. With this feature, you can control the satellite on your television. Adjust the satellite antenna position for each satellite. By storing these settings, the antenna can be moved to a previously saved location when needed.

1. In TV mode, press the **⊞**, select **Source** and press the **OK**.
2. Select **Satellite** and press the **OK**.
3. Press the **⊞**, select **Settings** and press the **OK**.
4. Select **Channels & Inputs** option **OK** and press.
5. Select **Channels** option, and press the **OK**.
⇒ **Channel** menu will be displayed.
6. Select **Satellite** and press the **OK**.
7. Select **Channel Installation Mode** option, and press the **OK**.
8. Select **Satellite (Standard)** if you are using an operator, select **Satellite (Operator Mode)**, and press the **OK**.
9. Select **Automatic Channel Scan** option, and press the **OK**.
⇒ **Satellite Antenna Type** menu will be displayed.

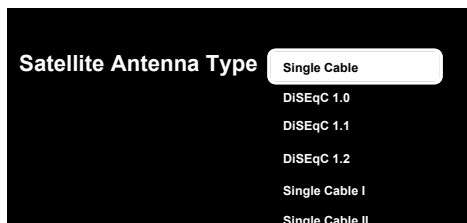

10. Select **DiSEqC 1.2** and press the **OK**.

11. Select **My Longitude** option, and press the **OK**. Then enter your longitude with the **1 ... 0**.

12. Select **My Latitude** option, and press the **OK**. Then enter your latitude with the **1 ... 0**.

13. Select **Next** option and press the **OK**.

14. Select the satellite you want to search for and press the **OK**.

15. Select **LNB Settings** and press the **OK**.

16. Select **Motor Settings** and press the **OK**.

⇒ **Motor Settings** menu will be displayed.

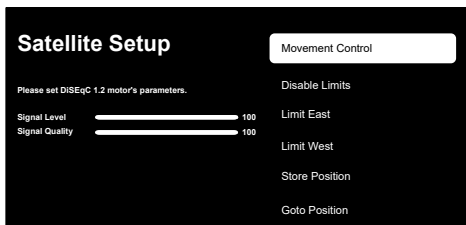

17. Select **Movement Control** and press the **OK**.

18. Select the Setting options with the **▲/▼**.

⇒ **Movement Control**: Press the **OK**, select between **Nonstop**, **Step**, **Timeout** and **USALS**.

⇒ **Step**: Moves the antenna in the west or east direction by the specified step size.

⇒ **Step Size**: Press the **OK**, select how many steps the antenna should rotate with the **1 ... 0**.

⇒ **Timeout**: Press the **OK**, select the timeout period for the rotation of the antenna with the **1 ... 0**.

⇒ **USALS: Movement Control** select **USALS** from the menu. Select **Timeout** and press the **OK**. Select the option to go to the angle of x. x and press the **OK**.

⇒ **Move to East**: Adjusts the antenna for selected antenna. To move the antenna to the **East** press the **OK**.

⇒ **Move to West**: Adjusts the antenna for selected antenna. To move the antenna to the **West** press the **OK**.

⇒ **Stop Movement**: Press the **OK** to stop the antenna.

Note:

- When the Motion Control is selected as **USALS**, the **Move to East**, **Move to West** and **Stop Movement** options are not displayed in the menu.

19. To return to the **Motor Settings** menu, press the **←**.

20. Select the Setting options with the ▲/▼.

- ⇒ **Disable Limits:** Removes maximum rotation limits of the antenna.
- ⇒ **Limit East:** Sets the limit position that the antenna can turn to east at maximum and allows the antenna to move within the specified limits.
- ⇒ **Limit West:** Sets the limit position that the antenna can turn to west at maximum and allows the antenna to move within the specified limits.

21. Return to the **Automatic Channel Scan** menu by pressing the ⬅ twice.

22. Select the **Scan Mode Network** or **Full**.

23. Select **Scan Type**.

- ⇒ Select **Free** for unencrypted channels only
- ⇒ Select **Encrypted Channels Only** for encrypted channels only
- ⇒ Select **All** for all satellite channels.

24. Select **Store Type**.

- ⇒ Select **Only Digital Channels** for TV channels only
- ⇒ Select **Only Radio Channels** for radio channels only
- ⇒ Select **All** for scanning both options.

25. To return to the **Satellite Selection** menu, press the ⬅.

Note:

- Make the settings described in steps 15 to 26 for each satellite you want to scan.

26. Select **Next** option and press the OK.

- ⇒ **Channel Scan** menu will be displayed.

27. Select **Scan** option, and press the OK.

- ⇒ **Automatic Search** menu will be displayed and the search for TV stations shall start.
- ⇒ Search may take several minutes depending on the number of television stations received.

28. Press the ⬅ to return to the previous menu or ⬆ to return to Home menu.

20.6 Searching for Newly Added Digital Channels with Satellite Update

With the satellite update feature, only newly added channels are found and saved at the end of the programme list.

1. In TV mode, press the ⌂, select **Source** and press the OK.
2. Select **Satellite** and press the OK.
3. Press the ⌂, select **Settings** and press the OK.
4. Select **Channels & Inputs** option, and press OK.
5. Select **Channels** and confirm with the OK.
 - ⇒ **Channel** menu will be displayed.
6. Select **Satellite** and press the OK.
7. Select **Channel Installation Mode** option, and press the OK.
8. Select **Satellite (Standard)** if you are using an operator, select **Satellite (Operator Mode)**, and press the OK.

9. Select **Satellite Update** option and press the OK.
 - **Automatic Search** menu will be displayed and the search for TV stations shall start.
 - Search may take several minutes depending on the number of television stations received.

10. Press the ⬅ to return to the previous menu or ⬆ to return to Home menu.

20.7 Searching for Cable-Connected Digital Television Channels Automatically

1. In TV mode, press the ⌂, select **Source** and press the OK.

2. Select **Cable** and press the **OK**.
3. Press the **⚙️**, Select **Settings** and press the **OK**.
4. Select **Channels & Inputs** option, and press **OK**.
5. Select **Channels** option, and press the **OK**.
 - ⇒ **Channel** menu will be displayed.
6. Select **Cable** and press the **OK**.
 - ⇒ **Channels** menu will be displayed.

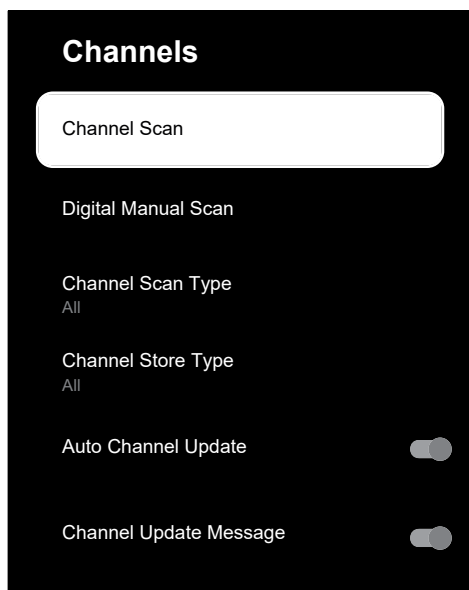

7. Select **Channel Scan Type** and press the **OK**.
 - ⇒ Select **Only Free Channels** for unencrypted channels only
 - ⇒ Select **Encrypted Channels Only** for encrypted channels only
 - ⇒ Select **All** for all cable channels.

8. Select **Channel Store Type**.
 - ⇒ Select **Only Digital Channels** for TV channels only
 - ⇒ Select **Only Radio Channels** for radio channels only
 - ⇒ Select **All** for scanning both options.
9. Select **Channel Scan** and press the **OK**.
 - ⇒ **Cable Scan Configure** menu will be displayed.

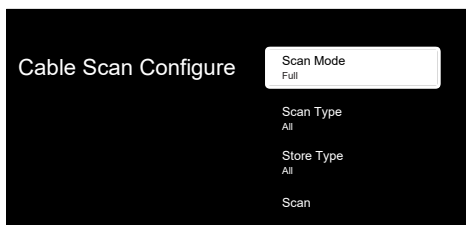

10. Select **Scan Mode** and select between **Advanced**, **Quick** or **Full**.
11. Select **Frequency (KHz)** and press the **OK**, enter the frequency with the **1...0**.
12. Select **Network ID** and press the **OK**, enter the frequency with the **1...0**.

Note:

- When the scan mode is selected as **Full**, the **Frequency (KHz)** and **Network ID** are not displayed in the menu.

13. Select **Scan** option, and press the **OK**.
14. **Automatic Search** menu will be displayed and the search for TV stations shall start.
 - ⇒ Search may take several minutes depending on the number of television stations received.

15. Press the **⬅️** to return to the previous menu or **🏠** to return to Home menu.

20.8 Searching for Cable-Connected Digital Television Channels Manually

1. In TV mode, press the **⚙️**, select **Source** and press the **OK**.

2. Select **Cable** and press the **OK**.
3. Press the **⊞**, select **Settings** and press the **OK**.
4. Select **Channels & Inputs** option **OK** and press.
5. Select **Channels** option, and press the **OK**.
 - ⇒ **Channel** menu will be displayed.
6. Select **Cable** and press the **OK**.
7. Select **Channel Scan Type**.
 - ⇒ Select **Only Free Channels** for unencrypted channels only
 - ⇒ Select **Encrypted Channels Only** for encrypted channels only
 - ⇒ Select **All** for all cable channels.
8. Press the **←** to return to the previous menu.
9. Select **Channel Store Type**.
 - ⇒ Select **Only Digital Channels** for TV channels only
 - ⇒ Select **Only Radio Channels** for radio channels only
 - ⇒ Select **All** for scanning both options.
10. Select **Digital Manual Scan** and press the **OK**.
 - ⇒ **Digital Manual Scan** menu will be displayed.

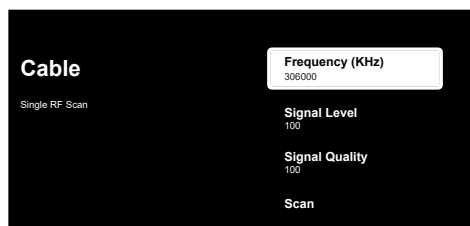

11. Select **Frequency** option, and press the **OK**.
 - ⇒ Enter channel frequency with the **1** ... **0**.

12. Select **Scan** option, and press the **OK**.
13. **Automatic Search** menu will be displayed and the search for TV stations shall start.
 - ⇒ Search may take several minutes depending on the number of television stations received.
14. Press the **←** to return to the previous menu or **⬆** to return to Home menu.

20.9 Setting Up Antenna-Connected Digital Television Channels Automatically

1. In TV mode, press the **⊞**, select **Source** and press the **OK**.
2. Select **Antenna** option **OK** and press.
3. Press the **⊞**, Select **Settings** and press the **OK**.
4. Select **Channels & Inputs** option **OK** and press.
5. Select **Channels** option, and press the **OK**.
6. **Channels** menu will be displayed.
7. Select **Antenna** option **OK** and press.
 - ⇒ **Channels** menu will be displayed.

Channels

Channel Scan

Update Scan

Digital Manual Scan

Manual Channel Update

Channel Scan Type

All

Channel Store Type

All

8. Select **Channel Scan Type** and press the **OK**.

- ⇒ Select **Only Free Channels** for unencrypted channels only
- ⇒ Select **Encrypted Channels Only** for unencrypted channels only
- ⇒ Select **All** for all channels.

9. Press the **←** to return to the previous menu.

10. Select **Channel Store Type** and press the **OK**.

- ⇒ Select **Only Digital Channels** for TV channels only
- ⇒ Select **Only Radio Channels** for radio channels only
- ⇒ Select **All** for scanning both options.

11. Select **Channel Scan** and press the **OK**.

12. **Automatic Search** menu will be displayed and the search for TV stations shall start.

- ⇒ Search may take several minutes depending on the number of television stations received.

13. Press the **←** to return to the previous menu or **⬆** to return to Home menu.

20.10 Updating Antenna-Connected Digital Television Channels Automatically

With update scan feature, only newly added channels are found and saved at the end of the programme list.

1. In TV mode, press the **⊗**, select **Source** and press the **OK**.
2. Select **Antenna** option **OK** and press.
3. Press the **⊗**, select **Settings** and press the **OK**.
4. Select **Channels & Inputs** option, and press **OK**.
5. Select **Channels** option, and press the **OK**.
⇒ **Channel** menu will be displayed.
6. Select **Antenna** option **OK** and press.
7. Select **Update Scan** and press the **OK**.

Channels

Channel Scan

Update Scan

Digital Manual Scan

Manual Channel Update

Channel Scan Type

All

Channel Store Type

All

8. **Automatic Search** menu will be displayed and the search for TV stations shall start.

⇒ Search may take several minutes depending on the number of television stations received.

9. Press the **←** to return to the previous menu or **⬆** to return to Home menu.

20.11 Setting Up Antenna-Connected Digital Television Channels Manually

1. In TV mode, press the **⚙**, select **Source** and press the **OK**.

2. Select **Antenna** option **OK** and press.

3. Press the **⚙**, select **Settings** and press the **OK**.

4. Select **Channels & Inputs** option **OK** and press.

5. Select **Channels** option, and press the **OK**

⇒ **Channel** menu will be displayed.

6. Select **Antenna** option **OK** and press.

7. Select **Digital Manual Scan** option, and press the **OK**.

⇒ **Digital Manual Scan** menu will be displayed.

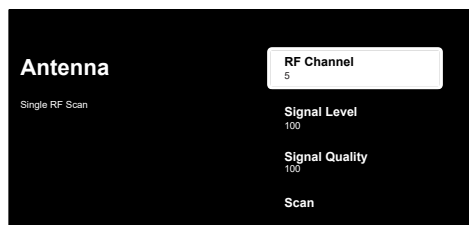

8. From **RF Channel** option, select the frequency you would like to scan with **◀/▶**

9. To start manual scanning, select **Scan** and press **OK**.

⇒ The scan starts and the number of digital channels found is displayed in the menu.

⇒ Search may take several minutes depending on the number of television stations received.

10. Press the **←** to return to the previous menu or **⬆** to return to Home menu.

20.12 Setting Up Antenna-Connected Analogue Television Channels Automatically

1. In TV mode, press the **⚙**, select **Source** and press the **OK**.

2. Select **ATV** and press the **OK**.

3. Press the **⚙**, select **Settings** and press the **OK**.

4. Select **Channels & Inputs** option **OK** and press.

5. Select **Channels** option, and press the **OK**.

6. Select **Analog** option, and press the **OK**.

7. Select **Channel Scan** and press the **OK**.

Channels



Channel Scan

Update Scan



Analogue Manual Scan

8. The scan starts and the number of analogue channels found is displayed in the menu.



⇒ Search may take several minutes depending on the number of television stations received.

9. Press the  to return to the previous menu or  to return to Home menu.

20.13 Updating Antenna-Connected Analogue Television Channels Automatically

1. In TV mode, press the , select **Source** and press the .

2. Select **ATV** and press the .

3. Press the , select **Settings** and press the .

4. Select **Channels & Inputs** option  and press.

5. Select **Channels** option, and press the .

⇒ **Channel** menu will be displayed.

6. Select **Analog** option, and press the .

7. Select **Update Scan** and press the .

Channels



Channel Scan

Update Scan



Analogue Manual Scan

8. The scan starts and the number of analogue channels found is displayed in the menu.



⇒ Search may take several minutes depending on the number of television stations received.

9. Press the  to return to the previous menu or  to return to Home menu.

20.14 Setting Up Antenna-Connected Analogue Television Channels Manually

1. In TV mode, press the , select **Source** and press the .

2. Select **ATV** and press the .

3. Press the , select **Settings** and press the .

4. Select **Channels & Inputs** option  and press.

5. Select **Channels** option, and press the **OK**.
⇒ **Channel** menu will be displayed.
6. Select **Analog** option, and press the **OK**.
7. Select **Analogue Manual Scan** option, and press the **OK**.

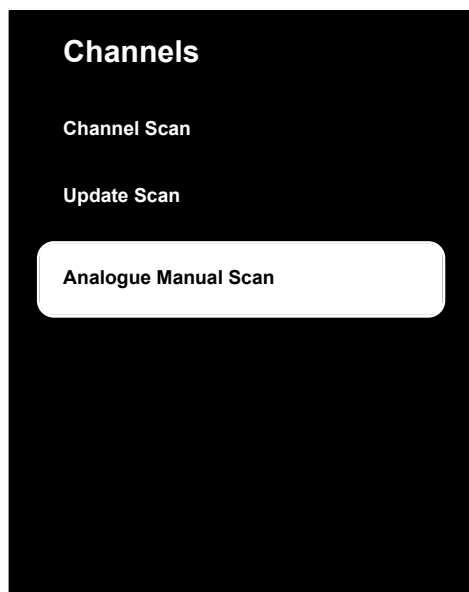

8. Select **Starting Frequency (MHz)** option, and press the **OK**. Enter the frequency you want to perform a scan on with the **1 0**.
9. Select **Scan Upwards** to search upwards from the frequency you have entered and select **Scan Downwards** to search downwards, and press the **OK**.
10. The scan starts and the number of analogue channels found is displayed in the menu.
⇒ Search may take several minutes depending on the number of television stations received.
11. Press the **←** to return to the previous menu or **⏪** to return to Home menu.

21 Additional Information

Default Satellite	21
LNB Power Supply	13/18 V, 14/19 V*, maximum 500 mA
LNB switching signal	0/22 kHz 650 mV +/- 250 mV Vpp
DiSEqC	1.0 operation, 1.1 operation, 1.2 operation
Digital Stream Reception Ranges	
Satellite (DVB-S)	
Ku Band	10,700 MHz... 12,750 MHz
Modulation	DVBS QPSK, DVBS2 QPSK, 8 PSK
IF Band	950 MHz... 2150 MHz
Signal Level	-25 dBm... -65 dBm
Cable (DVB-C)	
General Band	110 MHz... 862 MHz
Modulation	16 QAM, 32 QAM, 64 QAM, 128 QAM, 256 QAM
Symbol Rate	4.0 Msym/s... 7.2 Msym/s
Terrestrial (DVB-T)	
UHF/VHF-Band	Bandwidth 7 MHz and 8 MHz
FFT Size	2 k, 8 k
Modulation	16 QAM, 64 QAM, QPSK
Protection Interval	1/4, 1/8, 1/16, 1/32
Terrestrial (DVB-T2)*	
UHF/VHF-Band	Bandwidth 7 MHz and 8 MHz
FFT Size	1 k, 2 k, 8 k, 16 k, 32 k
Modulation	16 QAM, 64 QAM, 256 QAM, QPSK
Protection Interval	1/4, 19/256, 1/8, 19/128, 1/16, 1/32, 1/128
Channel Memory	
Satellite (DVB-S)	6000
Cable (DVB-C)	1000
Terrestrial (DVB-T)	1000
Analogue	99
Supported Media Formats	
Picture	jpg/jpe, bmp, png
Music	m4a, aac
Video	mov, xvid, mpg, mpe, vob, dat, trp, ts, avi, mp4, mkv
(*) Optional, not available on all products. The right of making technical changes and errors is reserved.	



Features described here are for informative purposes only. All features are not available on all TV models.

ARC

With ARC (Audio Return Channel) the audio signal of the television programme can be played back via a HDMI cable or an optical cable with a multi-channel amplifier.

Backlight

Manual setting for back lighting (only active if dynamic back lighting is switched to "OFF"). This setting also directly impacts power consumption.

Block Noise Reduction

This function can only be selected with digital reception sources and AV presets. It reduces any interference from artefacts (pixel blocks) from digital programmes due to MPEG compression (such as from DVB-T receivers and lower transmission rates or DVD players).

Common Interface

It is an interface used in DVB receivers. Scrambled channels can only be viewed with a CA module suitable for the encoding system and the corresponding smart card.

DiSEqC

DiSEqC (Digital Satellite Equipment Control) is a digital system that ensures that the motorized multiple-LNB satellite systems are controlled.

DiSEqC is required when two or more satellite locations need to be controlled.

DiSEqC 1.0

It is used when more than one LNB is used on an antenna and/or when different satellite signals are used by using more than one antenna. DiSEqC1.0 can support a maximum of 4 LNBs or 4 Antennas.

DiSEqC 1.1

For use in systems where multiple LNBs or antennas are used (diagonal, cascading). DiSEqC1.1 can support a maximum of 16 LNBs or 16 Antennas.

DiSEqC 1.2

Supports motorized antenna systems. Antenna motors can be controlled manually on the television.

Domain Name System

The domain name system (DNS) is one of the most important services on the Internet. Its main function is to convert an Internet address into the corresponding IP address.

DVB-C

DVB-C (Digital Video Broadcasting – Cable) is a type of DVB used for the transmission of radio and television signals through a cable connection.

DVB-S/S2

DVB-S/S2 (Digital Video Broadcasting – Satellite) broadcasts the DVB signals through the satellite.

DVB-T/T2

DVB-T/T2 (Digital Video Broadcasting – Terrestrial) is a type of DVB used for the transmission of radio and television signals through terrestrial channels.

Dynamic Backlight

Here the device optimally adjusts the back lighting for the picture content by regulating the back lighting depending on the average picture brightness. If a picture has predominantly dark areas, then the black level displayed is improved by downward adjustment of the back lighting (in this case the display of the dark areas is improved), and with predominantly bright picture material the back lighting is maximised in order to display these areas more brightly.

Dynamic Contrast

This function dynamically and optimally adjusts the contrast for the respective picture content by analysing images and then alter-

ing this depending on a change in contrast. This increase in the contrast however, may also reduce the visible brightness levels in the picture.

Firmware Version

Firmware is the term used for software that is embedded in a programmed chip (micro-controller). It is mostly stored in a flash memory, an EPROM or an EEPROM. The firmware contains functions for controlling the device.

Film Mode

Detects and processes feature films automatically for all channel sources. This means that you get the optimum picture at all times.

This functions in the modes 480i, 576i and 1080i in TV playback and for other channel sources.

If the "Movie Mode" is switched on for programmes without a feature film signal, minor problems such as picture freeze, defective subtitles or fine lines in the picture could occur.

Gamma

This setting establishes which brightness value should be displayed for which digital transmission value. Most recordings are transmitted with a gamma value of 2.2 (all Windows PCs and newer PCs with a MAC operating system work with this; older MAC systems and transmissions without colour profile mostly operate with a gamma value of 1.8).

Gateway

Gateway allows networks, which may be based on completely different protocols, to communicate with each other. In the home area, a combination of the router and the DSL modem are used as an Internet gateway.

Hardware Version

Hardware in this context means the device. This includes all components such as processor, display, etc.

HbbTV

HbbTV is the interactive successor of video text, which has content with a modern design, high resolution images and video sequences as well as media libraries.

For full functionality of HbbTV, the TV must be connected to the Internet.

HD / Full HD / UHD (4K)

High Definition (HD) TV is a general name for the television standard that has increased vertical, horizontal and timewise definition.

Full HD is a feature of devices with HDTV that can output or record 1920x1080 pixels of definition.

Resolution for UHD (4K) is 3840 x 2160.

HDMI CEC

This feature utilizes CEC (Consumer Electronics Control) protocol.

CEC enables external devices that are connected to the HDMI socket with the HDMI cable to be controlled via the remote control.

IP Address

An IP address (Internet protocol address) is used to uniquely identify the address of computers and other devices in an IP network. The most well-known network in which IP addresses are used is the Internet. Here, for example, web servers are addressed using the IP address. The IP address can be provided automatically by the router (automatic address) or can be entered manually in the router (static address). If it is entered manually, this address must be entered in the TV set.

JPEG

JPEG stands for Joint Picture Experts Group. It is the compressing process of picture data.

LNB

The Low Noise Block resides at the centre of parabolic antenna.

Eg. It implements the satellite frequencies that are between 10.7–11.75 or 11.8–12.75 GHz in 950 to 2150 MHz and ensures cable

transmission with coaxial cables (and with fibre-optic cables recently) and reception with satellite receivers.

MP3

Compressed audio file format.

NAS (network attached storage)

The abbreviation NAS is used for devices that provide data from a hard drive to a network.

Network Mask

The network mask or net mask, sometimes also referred to as a subnet mask, is a bit mask that separates an IP address into a network part and a device/host part. It is used in IP networks to make routing decisions.

Network Name (SSID)

The network name (SSID – service set identifier) is the term used for the identification of a wireless network that is based on IEEE 802.11. Every wireless LAN has a configurable SSID, which uniquely identifies the wireless network. The character sequence of the network name can be up to 64 characters in length. It is configured in the base station (access point) of a wireless LAN and set on all clients which access it.

Noise Reduction

Reduces the "snow" areas by displaying the picture a bit sharper and creating a slight blur. Thus, it must be used as little as possible with good picture material.

Perfect Clear

Improves the general image by means of a gentle blue hue (giving the appearance of greater sharpness) and increases the black level by setting this entirely to black from a specific level of black hue. This reduces the visible grey values in the dark areas of the picture.

Proxy Server

A proxy or proxy server is a service programme for computer networks that administers data transfer. It makes data transfer faster, and can also increase security by implementing access control mechanisms. The transfer is conducted

between computers or programmes in computer networks. On the server side, the proxy acts as a client; on the client side, it acts as a server.

Router

A router is a network component that links several computer networks. Router analyses (on the basis of layer 3 information) the network packages of a protocol it receives and forwards it to the intended destination network. Conventional routers work on layer 3 of the application layer. A router has an interface for every network connected to it. When data is received, the router determines the correct path to the destination and thereby the suitable interface via which the data can be transferred. For this it uses a locally available routing table that specifies via which router connection a particular network can be reached.

SCR (Single Channel Router)

Single Cable System EN 50494.

If your antenna system is equipped with a single cable system multi switch, the television systems which are connected to this antennae system can receive television programmes independently from one another.

Security (WEP/WPA)

WEP (wired equivalent privacy) is the standard encryption algorithm for WLAN. It controls both access to the network as well as ensuring the confidentiality and integrity of data. This procedure is considered insecure nowadays. For this reason, recent WLAN installations should use the more secure WPA encryption.

Special IP Address

Private IP addresses belong to the particular IP address ranges that are not routed in the Internet. They can be used by anybody for private networks, such as LANs. Many computer networks require complete connectivity at IP level, but only limited access to the Internet. If such a computer network has a private IP address range, it forms an Intranet which cannot be accessed from the Internet as the Internet routers ignore private address ranges. A gateway or router

that is placed in this private network and which has a public address in the Internet as well as a private IP address makes the connection to the Internet. This can be performed by a proxy or using NAT/PAT/masking. As the address range used can only be viewed within the private network, the same range can also be used in other private networks. The unique nature of an IP address required by the Internet protocol is ensured by this restricted visibility.

Symbol Rate

It is the amount of the symbols transmitted in a unit of time in the digital transmission technology.

Transponder

It is a cluster of various transmitters in a frequency.

Vibrant Colour

Improves colour contrast and contrast setting. This setting is mostly too strong for use with normal pictures and should only be used where necessary (low or off) otherwise nuances in the image can be suppressed.

Wi-Fi

Wireless transmission of Internet and Intranet packets.

WMA

These formats enable recording and playback of audio files which sound as good as a CD, yet only occupy a fraction of the storage space.

23 Troubleshooting

If the remedies given below do not work, please consult an authorized service/dealer. Please bear in mind that malfunctions can also be caused by external devices such as video recorders or satellite receivers.

Note:

This is a Class A product. During operation the device can cause radio interference. In this case the user may have to remedy this. Please contact your specialist dealer.

Screen on No Signal message.

- Antenna cable not connected >>> Plug the antenna cable.

Screen on No Channel message.

- Channel scan not performed >>> Perform Channel Scan.

Poor picture contrast.

- Image settings are adjusted incorrectly >>> Adjust the brightness, contrast, colour and advanced image settings.
- Problem with the broadcast >> Test with a different channel.

Interference on the picture and/or sound.

- Interference caused by other devices near the TV set >>> Change the location of the appliance.

Shades, reflections and/or freezing on the image.

- Channel Tuning >>> Perform automatic or manual channel tuning.
- Antenna Setting >>> Have the antenna cable or system inspected.

No color.

- Color density at minimum >>> Increase color setting.
- TV standard setting (if setting option is available) >>> Select the correct color standard.
- Problem with the broadcast >> Test with another channel.

There is picture but no volume.

- Volume at minimum >>> Increase volume.

- Muted >>> Press the mute button or the Volume increase button.
- Problem with the broadcast >> Test with another channel.

Remote control does not operate.

- No optical connection >>> Point the remote control to the TV set.
- Remote control battery level low or batteries discharged >>> Check the batteries, replace them if required.
- Operating condition undefined >>> Switch off the TV by pressing the main power key (if any) or unplugging the mains plug, and leave it off for about 2 minutes.

Picture color is dark in PC mode.

- Image resolution and image frequency in the PC are incorrect >>> Change the setting on the PC (for example, picture resolution 1280 x 768, picture frequency 60Hz).

Warnings about the connection problems on the screen.

- Antenna cable not connected >>> Plug the antenna cable.
- No wireless network connection >>> Check the network connection settings.
- Modem may not have an internet connection or the connection may have a problem >>> Make sure that your modem is connected to the internet.

Videos in video applications are lagging during playback in wireless connection.

- Low Internet connection speed >>> Low Internet connection speed is a problem that is related with the speed of your subscription or a failure in the Internet infrastructure. Contact your Internet service provider.

Videos in video applications are lagging during playback in wired connection.

- Low Internet connection speed >>> Low Internet connection speed is a problem that is related with the speed of your subscription or a failure in the Internet infrastructure. Contact your Internet service provider.

Considerations Regarding Errors of Use and Warranty

The following defects can be rectified for a fee. Warranty conditions do not apply for any of these cases;

1. Damages and malfunctions caused by errors in use,
2. Damages and malfunctions during loading, unloading, transport, etc. following the delivery of the goods to the consumer,
3. Damages and malfunctions arising from the electricity (socket, voltage, grounding, etc.), water (water pressure, tap, etc.), natural gas, telephone, internet, etc. network and / or infrastructure (drain, floor, environment, etc.) of the location where the goods are used,
4. Damages and malfunctions caused by Acts of God, fire, flood, etc,
5. Damages and malfunctions arising from the use of the goods contrary to the issues in the description and user manuals,
6. Damages and malfunctions arising from the use of the goods for commercial or professional purposes as defined in the Law No. 6502 on the Protection of Consumers,
7. In the event of maintenance, repair or any other intervention to the goods by unauthorised persons, the warranty given to the goods shall expire.

The warranty period of the goods replaced during the warranty application is limited to the remaining warranty period of the purchased goods.

Manufactured by Arçelik A.Ş.

Origin: Turkey

