

Before using your Dawlance air conditioner, please read this manual carefully and keep it for future reference.

Remote Controller

User Manual

MODEL: EnerCon *Inverter* **15/30/45**

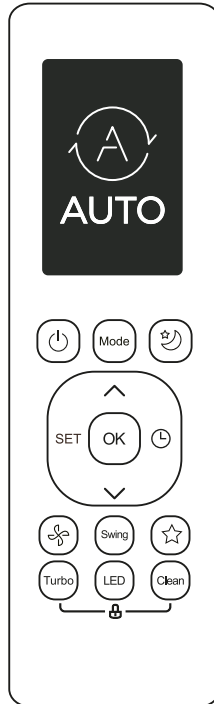

Read This Manual

Thank you for purchasing our air conditioner. Please read this manual carefully before operating your new air conditioning unit. Make sure to save this manual for future reference.

Table of Contents

Remote Controller Specifications	02
Handling the Remote Controller	03
Buttons and Functions	04
Remote Screen Indicators	07
How to Use Basic Functions	08
How to Use Advanced Functions	11

Remote Controller Specifications

Model	RG10B(D)/BGEF, RG10B(D1)/BGEFU1, RG10B1(D)/BGEF, RG10B2(D)/BGCEF, RG10B10(D)/BGEF, RG10A4(D)/BGEF, RG10A4(D1)/BGEFU1, RG10A5(D)/BGEF, RG10A5(D1)/BGEFU1, RG10A5(D1)/BGCEFU1, RG10A5(D)/BGCEF, RG10A11(D)/BGEF,
Rated Voltage	3.0V(Dry batteries R03/LR03×2)
Signal Receiving Range	8m
Environment	-5°C~60°C(23°F~140°F)

Quick Start Guide

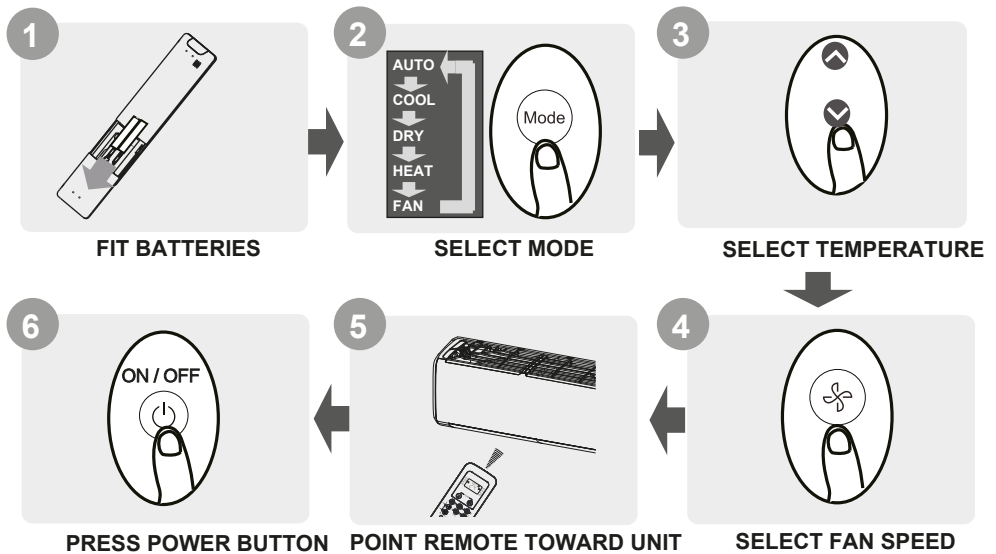

NOT SURE WHAT A FUNCTION DOES?

Refer to the **How to Use Basic Functions** and **How to Use Advanced Functions** sections of this manual for a detailed description of 'how to use your air conditioner'.

SPECIAL NOTE

- Button designs on your unit may differ slightly from the example shown.
- If the indoor unit does not have a particular function, pressing that function button on the remote control will have no effect.
- When there are wide difference between "Remote controller Manual" and "USER'S MANUAL" on function description, the description of "USER'S MANUAL" shall prevail.

Handling the Remote Controller

Inserting and Replacing Batteries

Your air conditioning unit may come with two batteries(some units). Put the batteries in the remote control before use.

1. Slide the back cover from the remote control downward, exposing the battery compartment.
2. Insert the batteries, paying attention to match up the (+) and (-) ends of the batteries with the symbols inside the battery compartment.
3. Slide the battery, slide back cover into place.

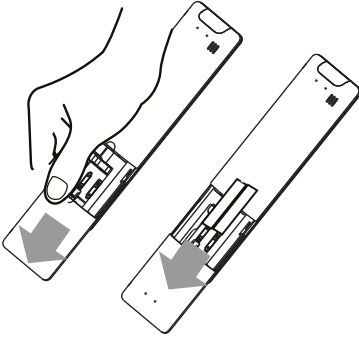

! BATTERY NOTES

For optimum product performance:

- Do not mix old and new batteries, or batteries of different types.
- Do not leave batteries in the remote control if you don't plan on using the device for more than 2 months.



BATTERY DISPOSAL

Do not dispose of batteries as unsorted municipal waste. Refer to local laws for proper disposal of batteries.

TIPS FOR USING REMOTE CONTROL

- The remote control must be used within 8 meters of the unit.
- The unit will beep when remote signal is received.
- Curtains, other materials and direct sunlight can interfere with the infrared signal receiver.
- Remove batteries if the remote will not be used more than 2 months.

NOTES FOR USING REMOTE CONTROL

The device could comply with the local national regulations.

- In Canada, it should comply with CAN ICES-3(B)/NMB-3(B).
- In USA, this device complies with part 15 of the FCC Rules. Operation is subject to the following two conditions:
 - (1) This device may not cause harmful interference, and
 - (2) this device must accept any interference received, including interference that may cause undesired operation.

This equipment has been tested and found to comply with the limits for a Class B digital device, pursuant to part 15 of the FCC Rules. These limits are designed to provide reasonable protection against harmful interference in a residential installation. This equipment generates, uses and can radiate radio frequency energy and, if not installed and used in accordance with the instructions, may cause harmful interference to radio communications. However, there is no guarantee that interference will not occur in a particular installation. If this equipment does cause harmful interference to radio or television reception, which can be determined by turning the equipment off and on, the user is encouraged to try to correct the interference by one or more of the following measures:

- Reorient or relocate the receiving antenna.
- Increase the separation between the equipment and receiver.
- Connect the equipment into an outlet on a circuit different from that to which the receiver is connected.
- Consult the dealer or an experienced radio/TV technician for help.
- Changes or modifications not approved by the party responsible for compliance could void user's authority to operate the equipment.

Buttons and Functions

Before you begin using your new air conditioner, make sure to familiarize yourself with its remote control. The following is a brief introduction to the remote control itself. For instructions on how to operate your air conditioner, refer to the **How to Use Basic Functions** section of this manual.

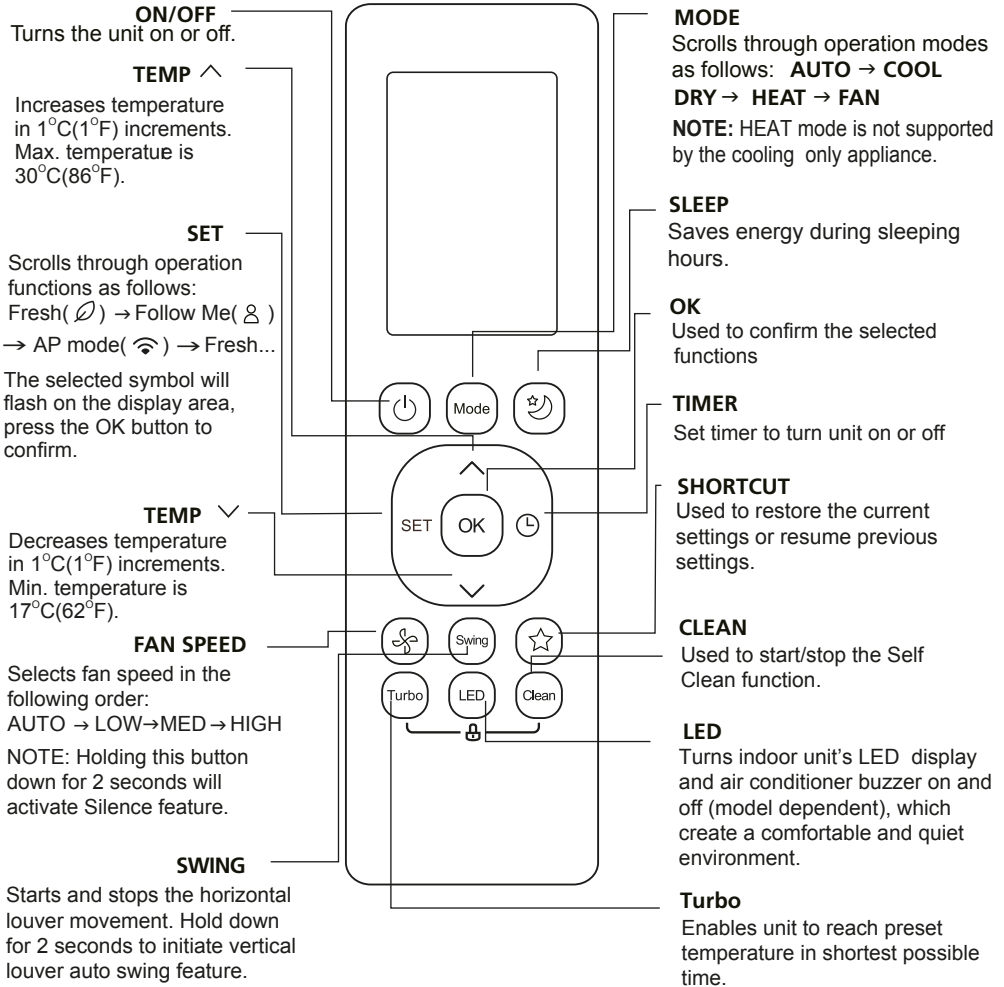

Model: RG10B(D)/BGEF & RG10B(D1)/BGEFU1 (Fresh feature is not available)
 RG10B2(D)/BGCEF (Cooling only models, AUTO mode and HEAT mode are not available)
 RG10B10(D)/BGEF(20-28°C).

NOTE: For **RG10B(D1)/BGEFU1** model, press together ^ & v buttons at the same time for 3 seconds, this will alternate the temperature display between the °C & °F scale.

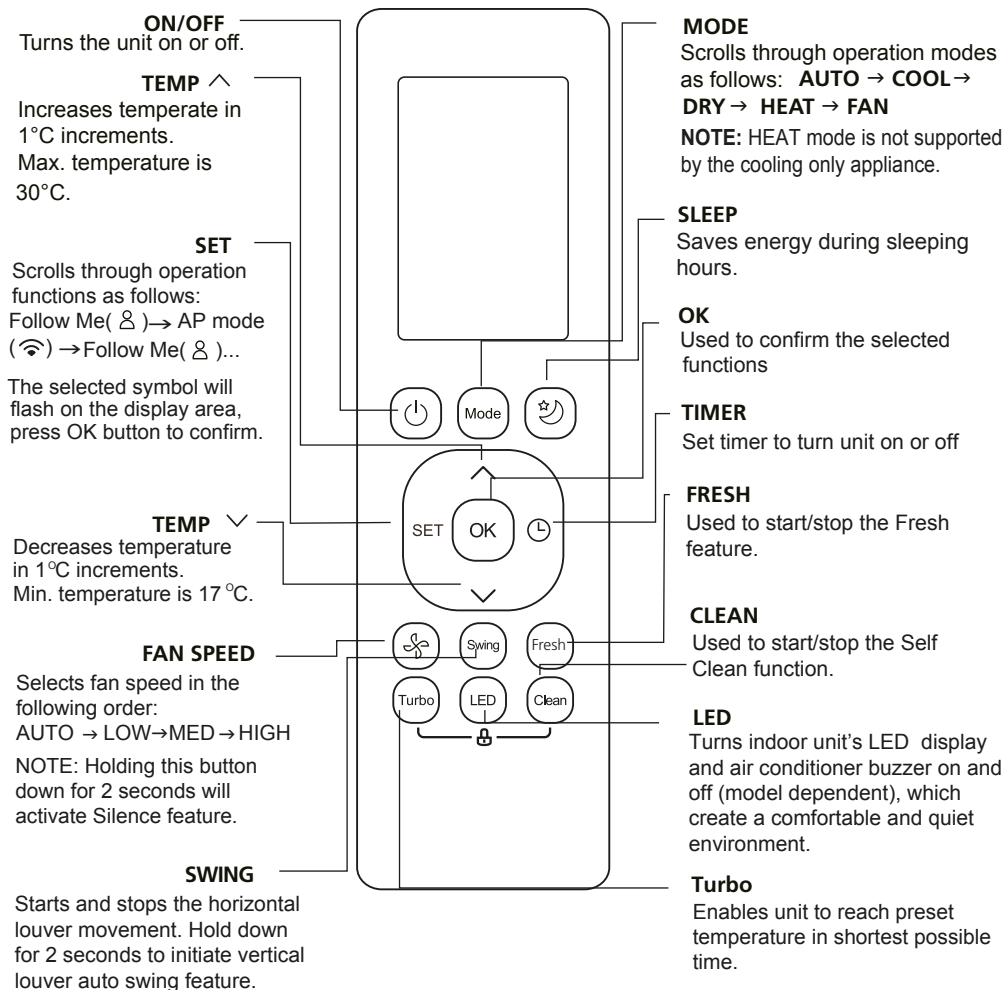

Model: RG10B1(D)/BGEF

ON/OFF
Turns the unit on or off.

TEMP ^
Increases temperature in 1°C(1°F) increments. Max. temperature is 30°C(86°F).

SET
Scrolls through operation functions as follows:
Fresh(🌀) → Sleep(🌙) → Follow Me(👤) → AP mode(📶) → Fresh...
The selected symbol will flash on the display area, press the OK button to confirm.

TEMP v
Decreases temperature in 1°C(1°F) increments. Min. temperature is 17°C(62°F).

FAN SPEED
Selects fan speed in the following order:
AUTO → LOW → MED → HIGH
NOTE: Holding this button down for 2 seconds will activate Silence feature.

SWING
Starts and stops the horizontal louver movement. Hold down for 2 seconds to initiate vertical louver auto swing feature.

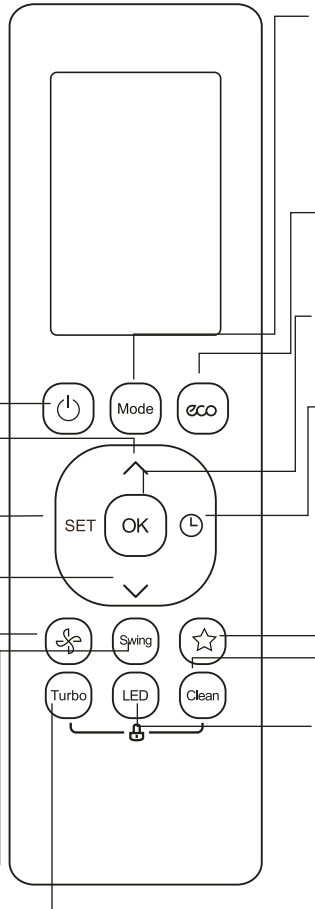

MODE
Scrolls through operation modes as follows: **AUTO → COOL → DRY → HEAT → FAN**
NOTE: HEAT mode is not supported by the cooling only appliance.

ECO
Press this button to enter the energy efficient mode.

OK
Used to confirm the selected functions

TIMER
Set timer to turn unit on or off

SHORTCUT
Used to restore the current settings or resume previous settings.

CLEAN
Used to start/stop the Self Clean function.

LED
Turns indoor unit's LED display and air conditioner buzzer on and off (model dependent), which create a comfortable and quiet environment.

Turbo
Enables unit to reach preset temperature in shortest possible time.

Model: RG10A4(D)/BGEF, RG10A4(D1)/BGEFU1, RG10A5(D)/BGEF, RG10A5(D1)/BGEFU1, RG10A5(D)/BGCEF & RG10A5(D1)/BGCEFU1 (Cooling only models, AUTO mode and HEAT mode are not available), RG10A11(D)/BGEF(20-28°C).

NOTE: For models of **RG10A4(D1)/BGEFU1**, **RG10A5(D1)/BGEFU1** and **RG10A5(D1)/BGCEFU1**, press together ^ & v buttons at the same time for 3 seconds, this will alternate the temperature display between the °C & °F scale. **Fresh** feature is not available for models of **RG10A4(D)/BGEF** and **RG10A4(D1)/BGEFU1**.

Remote Screen Indicators

Information are displayed when the remote controller is power up.

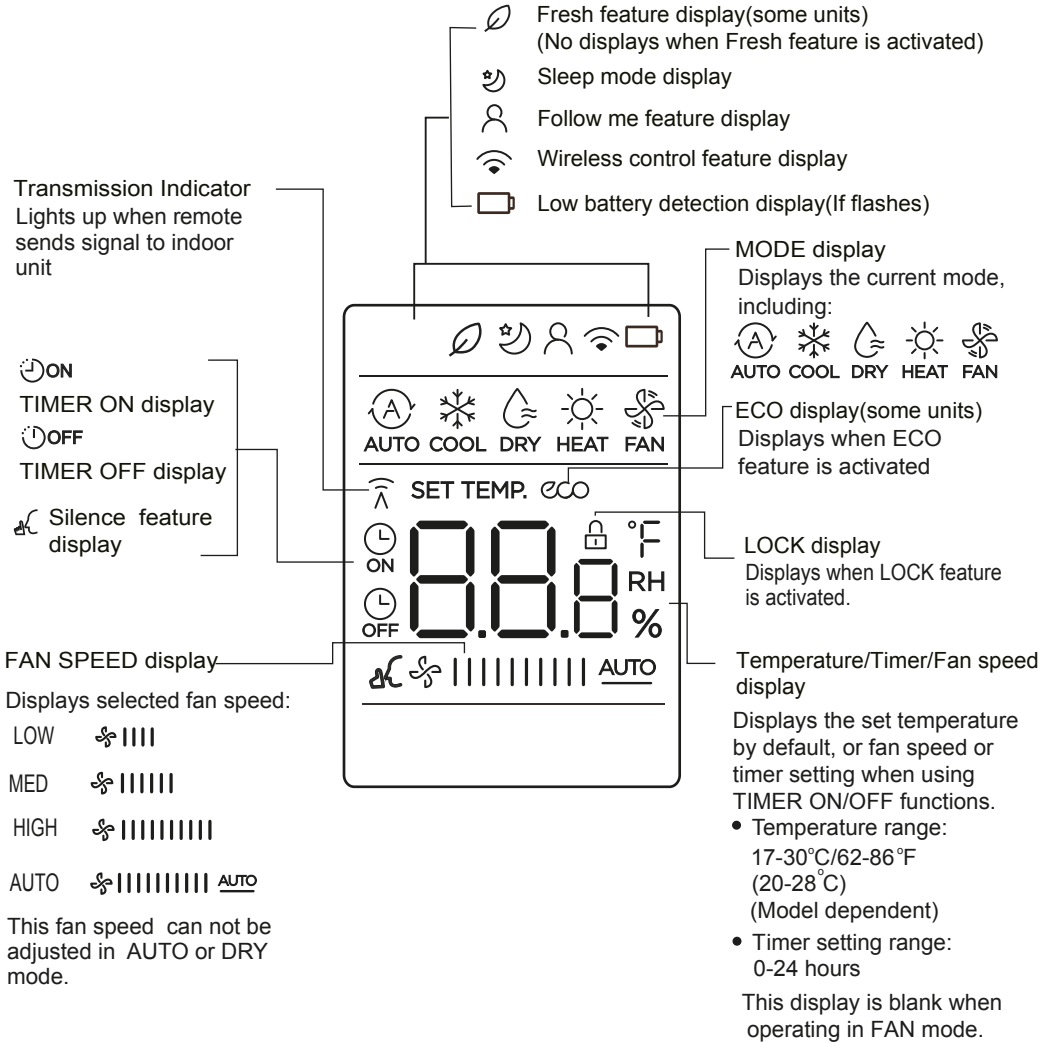

Note:

All indicators shown in the figure are for the purpose of clear presentation. But during the actual operation, only the relative function signs are shown on the display window.

How to Use Basic Functions

Basic operation

ATTENTION! Before operation, please ensure the unit is plugged in and power is available.

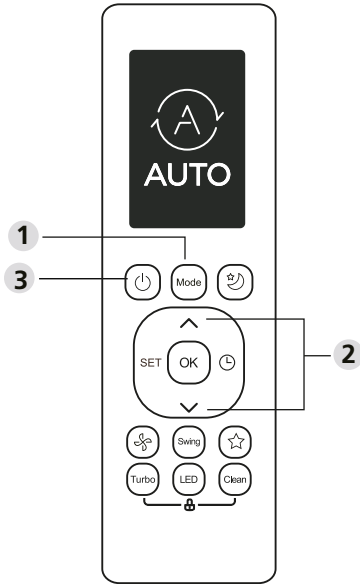

SETTING TEMPERATURE

The operating temperature range for units is 17-30°C (62-86°F)/20-28°C.

You can increase or decrease the set temperature in 1°C (1°F) increments.

AUTO Mode

In AUTO mode, the unit will automatically select the COOL, FAN, or HEAT operation based on the set temperature.

1. Press the **MODE** button to select **AUTO**.
2. Set your desired temperature using the **TEMP** ^ or **TEMP** v button.
3. Press the **ON/OFF** button to start the unit.

NOTE: FAN SPEED can't be set in AUTO mode.

COOL Mode

1. Press the MODE button to select **COOL** mode.
2. Set your desired temperature using the **TEMP** ^ or **TEMP** v button.
3. Press **FAN** button to select the fan speed: AUTO, LOW, MED or HIGH.
4. Press the **ON/OFF** button to start the unit.

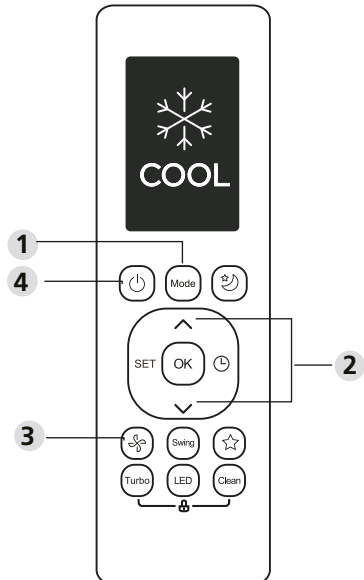

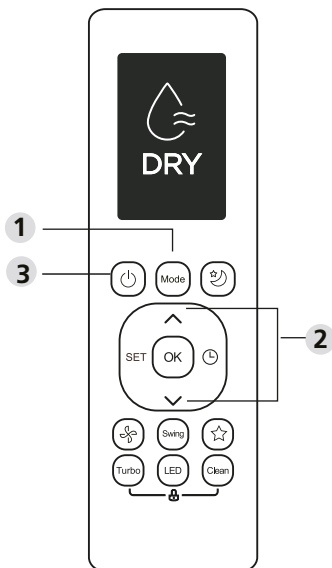

DRY Mode (dehumidifying)

1. Press the MODE button to select DRY.
2. Set your desired temperature using the **TEMP** ^ or **TEMP** v button.
3. Press the ON/OFF button to start the unit.

NOTE: FAN SPEED cannot be changed in DRY mode.

FAN Mode

1. Press the MODE button to select FAN mode.
2. Press **FAN** button to select the fan speed: AUTO, LOW, MED or HIGH.
3. Press the **ON/OFF** button to start the unit.

NOTE: You can't set temperature in FAN mode. As a result, your remote control's LCD screen will not display temperature.

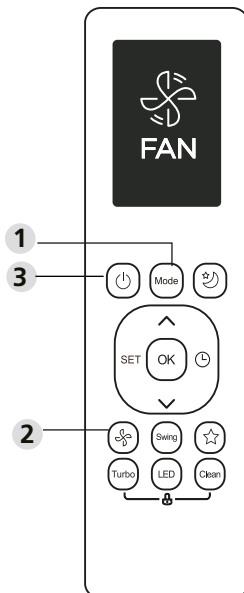

HEAT Mode

1. Press the MODE button to select **HEAT** mode.
2. Set your desired temperature using the **TEMP** ^ or **TEMP** v button.
3. Press **FAN** button to select the fan speed: AUTO, LOW, MED or HIGH.
4. Press the **ON/OFF** button to start the unit.

NOTE: As outdoor temperature drops, the performance of your unit's HEAT function may be affected. In such instances, we recommend using this air conditioner in conjunction with other heating appliances.

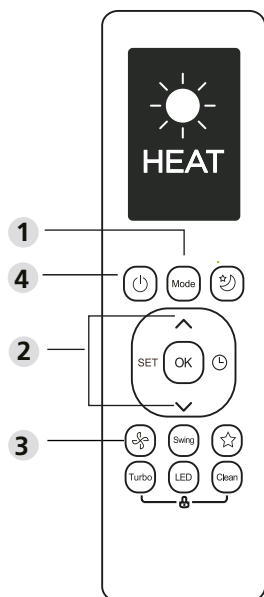

Setting the TIMER

TIMER ON/OFF - Set the amount of time, after which the unit will automatically turn on/off.

TIMER ON setting

Press TIMER button to initiate the ON time sequence.



Press Temp. up or down button for multiple times to set the desired time to turn on the unit.



Point remote to unit and wait 1sec, the TIMER ON will be activated.



TIMER OFF setting

Press TIMER button to initiate the OFF time sequence.



Press Temp. up or down button for multiple times to set the desired time to turn off the unit.



Point remote to unit and wait 1sec, the TIMER OFF will be activated.



NOTE:

1. When setting the TIMER ON or TIMER OFF, the time will increase by 30 minutes increments with each press, up to 10 hours. After 10 hours and up to 24, it will increase in 1 hour increments. (For example, press 5 times to get 2.5h, and press 10 times to get 5h.) The timer will revert to 0.0 after 24.
2. Cancel either functions by setting its timer to 0.0h.

TIMER ON & OFF setting(example)

Keep in mind that the time periods you set for both functions refer to hours after the current time.

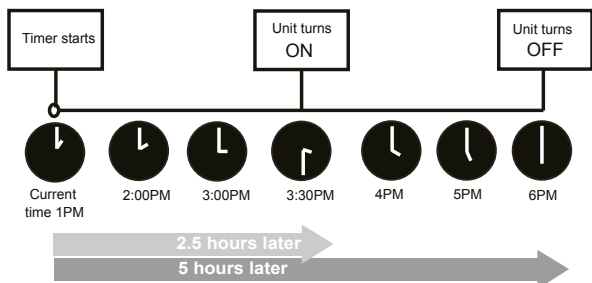
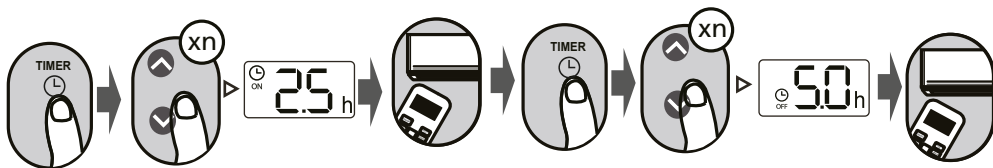

Example: If current timer is 1:00PM, to set the timer as above steps, the unit will turn on 2.5h later (3:30PM) and turn off at 6:00PM.

How to Use Advanced Functions

Swing function

Press Swing button

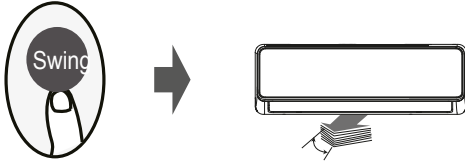

The horizontal louver will swing up and down automatically when pressing Swing button. Press again to make it stop.

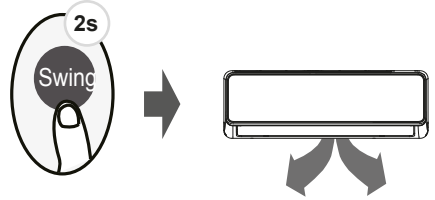

Keep pressing this button more than 2 seconds, the vertical louver swing function is activated. (Model dependent)

LED DISPLAY



Press LED button

Press this button to turn on and turn off the display on the indoor unit.

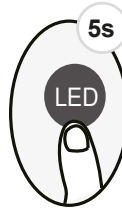

Press this button more than 5 seconds (some units)

Keep pressing this button more than 5 seconds, the indoor unit will display the actual room temperature. Press more than 5 seconds again will revert back to display the setting temperature.

Silence function



Keep pressing Fan button for more than 2 seconds to activate/disable Silence function (some units).

Due to low frequency operation of compressor, it may result in insufficient cooling and heating capacity. Press ON/OFF, Mode, Sleep, Turbo or Clean button while operating will cancel silence function.

ECO function

Press ECO button(some units)



Press ECO button to enter the energy efficient mode.

Note: This function is only available under COOL mode.

ECO operation:

Under cooling mode, press this button, the remote controller will adjust the temperature automatically to 24°C/75°F, fan speed of Auto to save energy (only when the set temperature is less than 24°C/75°F). If the set temperature is above 24°C/75°F, press the ECO button, the fan speed will change to Auto, the set temperature will remain unchanged.

NOTE:

Pressing the ECO button, or modifying the mode or adjusting the set temperature to less than 24°C/75°F will stop ECO operation.

Under ECO operation, the set temperature should be 24°C/75°F or above, it may result in insufficient cooling. If you feel uncomfortable, just press the ECO button again to stop it.

FP function



The unit will operate at high fan speed (while compressor on) with temperature automatically set to 8°C/46°F.

Note: This function is for heat pump air conditioner only.

Press this button 2 times during one second under HEAT Mode and setting temperature of 17°C/62°F or 20°C/68°F (for models RG10B10(D)/BGEF, RG10A11(D)/BGEF) to activate FP function.

Press On/Off, Sleep, Mode, Fan and Temp. button while operating will cancel this function.

LOCK function

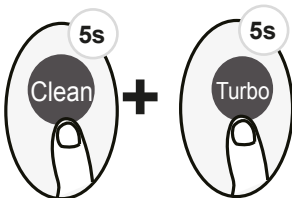

Press together **Clean** button and **Turbo** button at the same time more than 5 seconds to activate Lock function. All buttons will not response except pressing these two buttons for two seconds again to disable locking.

SHORTCUT function

Press SHORTCUT button(some units)



Push this button when remote controller is on, the system will automatically revert back to the previous settings including operating mode, setting temperature, fan speed level and sleep feature (if activated).

If pushing more than 2 seconds, the system will automatically restore the current operation settings including operating mode, setting temperature, fan speed level and sleep feature (if activated).

Clean Function

Press CLEAN button



Airborne bacteria can grow in the moisture that condenses around heat exchanger in the unit. With regular use, most of this moisture is evaporated from the unit. By pressing the CLEAN button, your unit will clean itself automatically. After cleaning, the unit will turn off automatically. Pressing the CLEAN button mid-cycle will cancel the operation and turn off the unit. You can use CLEAN as often as you like.

Note: You can only activate this function in COOL or DRY mode.

TURBO Function

Press TURBO button



When you select Turbo feature in COOL mode, the unit will blow cool air with strongest wind setting to jump-start the cooling process.

When you select Turbo feature in HEAT mode, for units with Electric heat elements, the Electric HEATER will activate and jump-start the heating process.

SET function

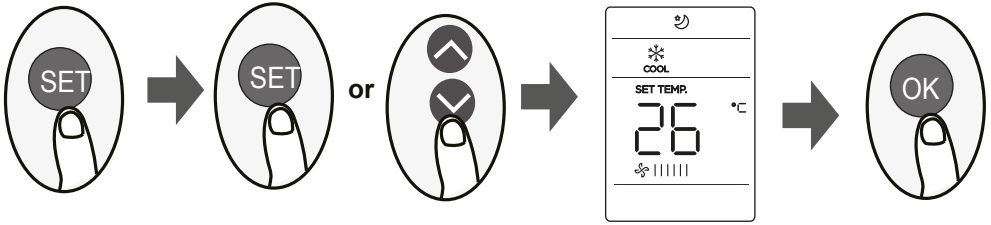

- Press the SET button to enter the function setting, then press SET button or TEMP \downarrow or TEMP \uparrow button to select the desired function. The selected symbol will flash on the display area, press the OK button to confirm.
- To cancel the selected function, just perform the same procedures as above.
- Press the SET button to scroll through operation functions as follows:

Fresh \ast (🍃) \rightarrow Sleep \ast (🌙) \rightarrow Follow Me (👤) \rightarrow AP mode (📶)

[*]: If your remote controller has Fresh and Sleep button, you can not use the SET button to select the Fresh and Sleep feature.

FRESH function (🍃) (some units) :

When the FRESH function is initiated, the ion generator is energized and will help to purify the air in the room.

Sleep function (🌙) :

The SLEEP function is used to decrease energy use while you sleep (and don't need the same temperature settings to stay comfortable). This function can only be activated via remote control.

For the detail, see "sleep operation" in "USER'S MANUAL"

Note: The SLEEP function is not available in FAN or DRY mode.

AP function (📶)(some units) :

Choose AP mode to do wireless network configuration. For some units, it doesn't work by pressing the SET button. To enter the AP mode, continuously press the LED button seven times in 10 seconds.

Follow me function (👤) :

The FOLLOW ME function enables the remote control to measure the temperature at its current location and send this signal to the air conditioner every 3 minutes interval. When using AUTO, COOL or HEAT modes, measuring ambient temperature from the remote control (instead of from the indoor unit itself) will enable the air conditioner to optimize the temperature around you and ensure maximum comfort.

NOTE: Press and hold Turbo button for seven seconds to start/stop memory feature of Follow Me function.

- If the memory feature is activated, "On" displays for 3 seconds on the screen.
- If the memory feature is stopped, "OF" displays for 3 seconds on the screen.
- While the memory feature is activated, press the ON/OFF button, shift the mode or power failure will not cancel the Follow me function.









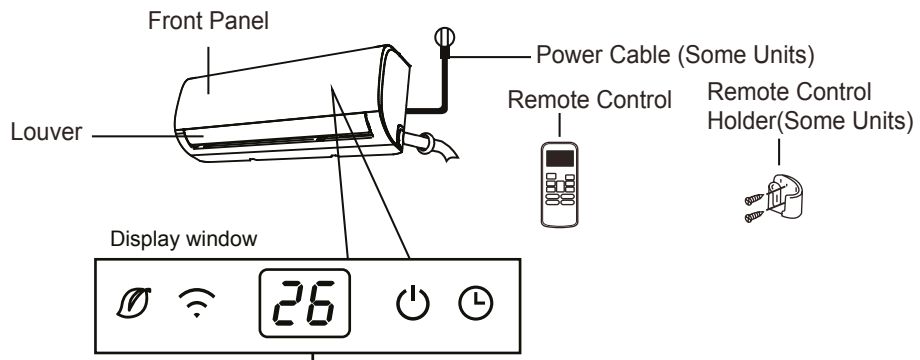





Unit Specifications and Features

Indoor unit display

NOTE: Different models have different front panel and display window. Not all the indicators described below are available for the air conditioner you purchased. Please check the indoor display window of the unit you purchased.

Illustrations in this manual are for explanatory purposes. The actual shape of your indoor unit may be slightly different. The actual shape shall prevail.



- “” when Fresh feature is activated(some units)
 - “” when Wireless Control feature is activated(some units)
 - “” when the unit is on.
 - “” when TIMER is set.
 - “” When ECO function(some units) is activated, the ‘88’ illuminates gradually one by one as   --set temperature-- ..... in one second interval.
- Displays temperature, operation feature and Error codes:
- “” for 3 seconds when:
 - TIMER ON is set (if the unit is OFF, “” remains on when TIMER ON is set)
 - FRESH, SWING, TURBO, or SILENCE features are turned on
 - “” for 3 seconds when:
 - TIMER OFF is set
 - FRESH, SWING, TURBO, or SILENCE features are turned off
 - “” when anti-cold air feature is turned on
 - “” when defrosting(cooling & heating units)
 - “” when unit is self-cleaning(some units)
 - “” when 8℃ heating feature is turned on(some units)

Display Code Meanings



**The widest service center network in the country with
more than 200 outlets**



**Dawlance Reliable service is available for all
household products**
Services at your doorstep within 24 hours
Call Center Services available
all week 24/7

Service UAN # 021-111-11-7359 (RELY)

Head Office: Dawlance Center 7/4, Civil Lines-9

Dr. Ziauddin Ahmed Road, Karachi.

Ph: (021) 35652450-9

E-mail: customer.service@dawlance.com.pk

Website: www.dawlance.com.pk

ڈاؤلینس ریلیائبل ہے!

 *Dawlance*
ریلائبیل ہے!