

Dawlance
ڈاؤلینس ریلائبل ہے!

Dawlance

FULLY AUTOMATIC WASHING MACHINE

User Manual

DWT 1165 PL

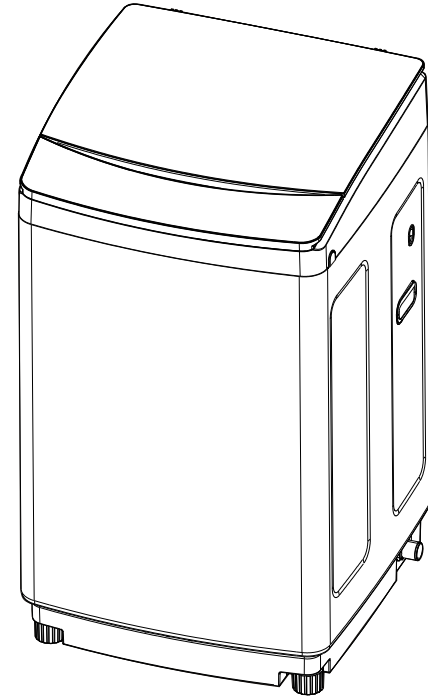

Before operating this unit, please read this manual thoroughly, and retain for future reference.

ڈاؤلینس ریلائبل ہے!

Contents

Before using

- Parts name..... 1
- Cautions.....2
- Installation and adjustment..... 4
- How to use drainpipe..... 5
- Water inlet installation..... 6

Operation

- Preparation before operation..... 8
- Load laundry..... 9
- Use of detergent..... 9
- Control panel instructions.....10
- Operation steps..... 12
- Maintenance..... 13
- Troubleshooting..... 14
- Other functions..... 16

Specifications

Model	DWT 1165 PL
Rated voltage and frequency	220V~ 50Hz
Water level/water volume (about)	65 Litre
Product dimension (WxDxH)	550x565x965 (mm)
Drum dimension (Dia x H)	455x345 (mm)
Rated input power-rated voltage	Refer to Specification LABEL
Inlet pressure	0.03 MPa – 0.3MPa

Parts name

Before using

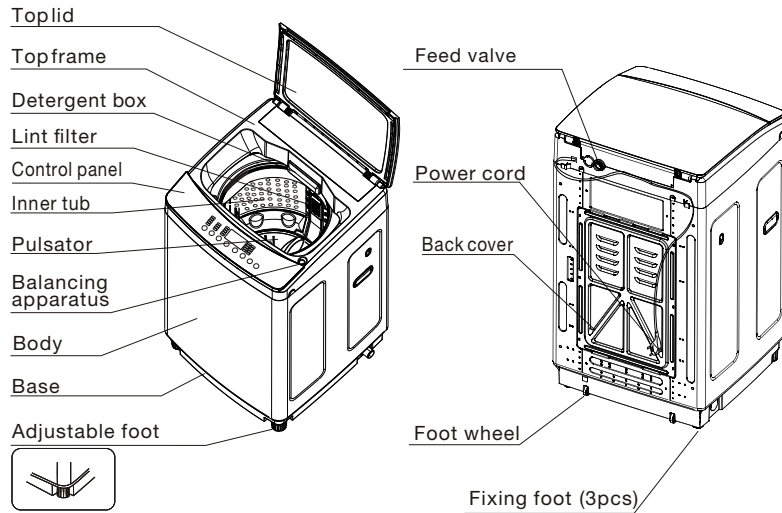

Accessories

	<p>The end connecting to the appliance</p> <p>Connector for water inlet hose and tap</p> <p>The end connecting to water inlet hose connector</p>	
Bottom cover (1pc)	Water inlet hose (1pc) Water inlet hose connector (1pc)	Drainpipe (1pc) Drainpipe clip (1pc)

Symbol definition

Warning symbols 	Pay special attention to the warning symbols. There may be serious risks to body safety or damages to the washing machine, if not followed.
Forbidden symbols 	Please stop doing the laundry in case of this symbol, otherwise it will damage the appliance or injure your body.

Cautions

Before using

Please insert the plug into the power socket with voltage rating 220V A/C.

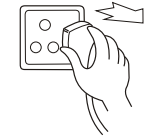

Always unplug the appliance and turn off the water when the power is cut, the machine is moving or getting cleaned, or it is not in use. Do not insert or pull off the plug with wet hands.

Do not bend, stretch, twist, strap, change, press or nip the electric cable. If the electric cable or plug is damaged or the socket becomes loose, they must be repaired or changed by our appointed repair stations or the professionals of our post-sale service department to avoid danger. The pin of the plug must remain clean. Please clean it carefully with dry cloth, if it is dirty.



Do not install the washing machine in bathroom or any other damp places. Do not wash the machine with water and do not put wet clothes on the control panel film.



Do not use water hotter than 50°C.



If the machine is placed on a carpeted floor, please adjust the feet in order to allow air to circulate freely.

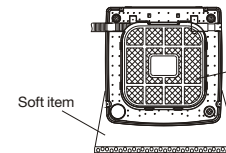

Ventilation holes at the bottom



Do not wash raincoat, bike cover, feather dress and such waterproof laundry as it will cause unusual vibrations during spinning.



Do not share the same socket with other electric appliances. Do not use a damaged plug or a loose socket.

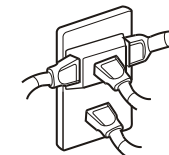

Cautions

Before using

Do not put your hands while the machine is working. It is dangerous even if the speed is very slow. Take special care of the children and forbid them to climb onto the washing machine.



It is dangerous to alter the specifications or attempt to modify this product in any way.



Do not overload the appliance or put any hot items (such as the kettle with hot water) on the washing machine.



Garments, which have been in contact with volatile petroleum products, should not be washed in the machine.

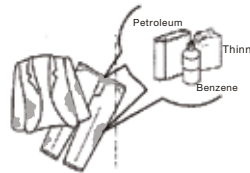

This appliance is not intended for use by persons (including children) with reduced physical, sensory or mental capabilities or lack of experience and knowledge, unless they have been given supervision or instruction concerning the use of the appliance by a person responsible for their safety. Children should be supervised to ensure that they do not play with the appliance.



Keep the appliance away from direct sunlight and heat sources like the heater.



Any objects such as coins, safety pins, nails, screws, stones or any other hard, sharp materials can cause extensive damage and must not be placed in the machine.



- Before washing, please ensure the tap is open and the inlet hose is installed properly.
- It is suggested to use low foam washing powder.

Installation and adjustment

Before using

Please install and adjust the machine according to the requirements of the manual. It is very important for your safety and correct operation.

Unpacking

- Unpack the carton and take out the bottom panel.
- Open the top lid of washing machine and take out all the accessories.
- Remove all wrappers, including the polystyrene base.
- You are advised to keep all the packaging for reuse, in case the machine is to be transported again.

Installing the bottom cover

To fix bottom cover, first cut the clamps on the cover and insert the cover in slots present at bottom in the direction mentioned in picture. Place two screws at the bottom in the present slot to permanently fix it.

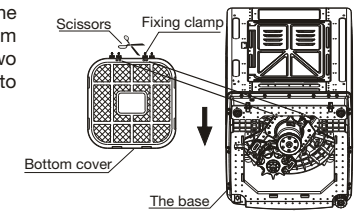

Positioning

The distance between the washing machine and the wall should be more than 50mm and the maximum allowed angle of the shank base of the machine is 1°. The slanting or rough ground may cause instability or the operation to stop. Please adjust it with the following methods:

● Horizontal checking

Observe, if the water bubble in balancing apparatus is in red circle or not. In red circle, it is horizontal.

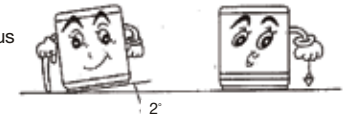

● Adjust the adjustable foot

1. Lift up the adjustable foot gently. Now loosen the adjustable nut and twist the adjustable foot.
2. Fasten the nut after adjustment.
3. Set the machine flat and observe again. If the water bubble is not in red circle, repeat the above procedure till the water bubble is in red circle.

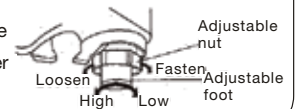

How to use drainpipe

Before using

Install drainpipe

Set drainpipe clip into the drainpipe to above 2-3cm (from the drainpipe end without pothook). Now, install the drainpipe into the right drainpipe connector and fix the drainpipe and drainpipe connector with the clip. After that, put the drainpipe clip on the cabinet.

How to change the direction of the drainpipe

1. Take off the drainpipe and its clip from the connector. Put a soft mat on the floor & make the washing machine front side down. Now, gently demount the screws on the back cover with a screwdriver and take it out. Demount one screw from the drainpipe connector (on right side of the washing machine) & loosen it.
2. Extrude the drainpipe with proper force and take out drainpipe hoop (on right of the washing machine). Loosen the inner drainpipe.



(Section sketch map for washing machine right side)

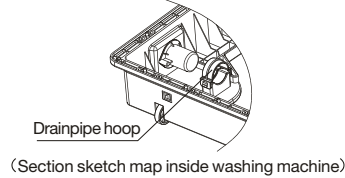

(Section sketch map inside washing machine)

3. With proper force, take down the drainpipe gate stopper the left side of the washing machine. The drainpipe gate stopper is fixed on washing machine base with two clips. Please see the fixing type from the place of back cover opening.
4. Pull the inner drainpipe to another side. Please do not make any distortion in the inner pipe; as per foregoing description, fix inner drainpipe with a drainpipe hoop. With one screw fix drainpipe connector and install the drainpipe gate stopper to another side. Make the washing machine stand gently and fix the back cover with a screw. Now, install the drainpipe and drainpipe clip into the drainpipe connector.

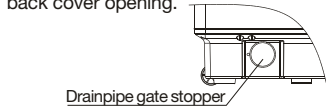

(Section sketch map for washing machine left side)

Water drainage

The drain hose should drain smoothly

1. The height of the drain hose should be less than 10cm, otherwise the drainage will not be smooth and would need a long time to drain. The machine may stop during working.
2. Do not step on or press the drain hose.
4. Purchase a proper hose, if you need an additional one. Its diameter should not be less than 30mm and length should not exceed 1.5m.

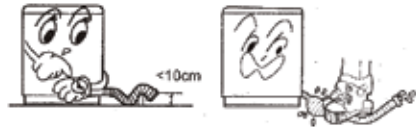

3. Cut the drain hose, if it is too long. Cut the front end of the hose slantingly to make drainage smooth.

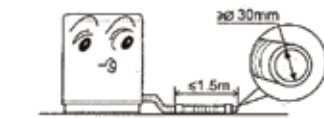

If the additional drain hose is too long, cut some at A or B point.

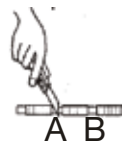

Water inlet installation

Before using

Tap selection

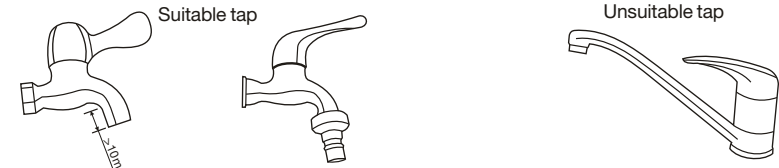

The front end should be longer than 10mm.
The tap exit end face should be flat and smooth, if not, file it to avoid leakage.

Connect the inlet hose connector with the tap

1. Press the lower end of the lock lever and push down the slider. Take off the inlet hose connector from the inlet hose, see illustration 1.
2. Loosen the four bolts on the inlet hose connector till the tap can be accessed. Then set the inlet hose connector to the tap, see illustration 2. (If the tap caliber is too large and could not fit the inlet hose end, unscrew the four bolts and take out the bushing. The tap exit end must be flat, otherwise it will leak, see illustration 3).

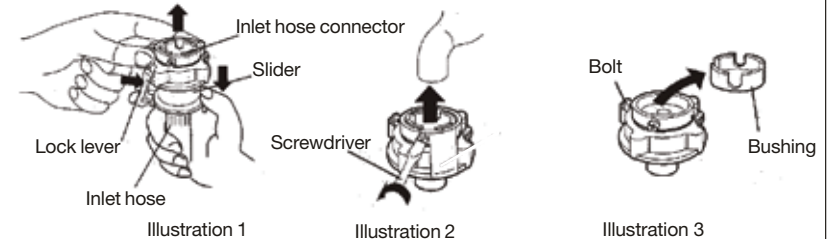

3. Fasten the four bolts in the inlet hose connector evenly, see illustration 4.
4. Twist the fastening nut as the illustration, see illustration 5.

Remark: Before twisting the nut, the threading should be about 4mm above the upper surface of the nut. After twisting, the threading becomes less than 2mm above the upper surface of the nut, see illustration 6.

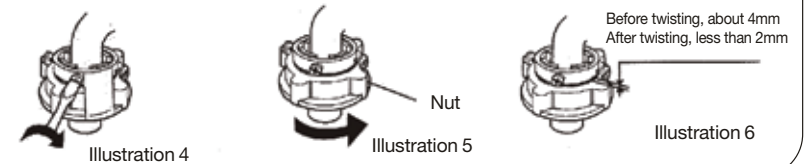

Water inlet installation

Before using

Connect the inlet hose with the washing machine

1. Do not take off the water absorption cushion. Please check if the cushion is dropped or damaged before each use. If it is, contact the seller immediately.
2. Put the inlet hose nut on the inlet valve connector.
3. Fasten the inlet hose nut and swing it gently to make sure it is suitable.

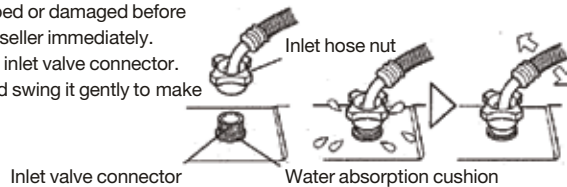

Cautions: When installing the washing machine, please use the new hose along with the washing machine. Old hose cannot be reused.

Connect the inlet hose connector with the inlet hose

1. Push down the slider and insert the inlet hose into the connector.
2. Hang the lock lever to the inlet hose connector and release the slider till a click sound is heard.

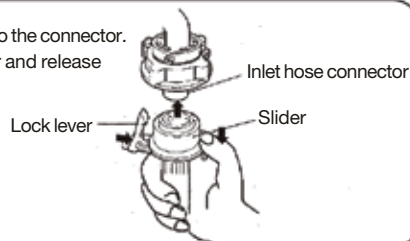

Check the connection between inlet hose connector and the tap

1. Swing the inlet hose gently to confirm if it is fastened.
2. After installation, open the tap and check if it leaks.
3. Do not bend the inlet hose with overstrain.
4. Before each usage, check the connection between inlet hose connector and the tap. Also, make sure that the inlet hose is installed properly. Confirm that they are firmly fitted to prevent dripping from improper installation position.

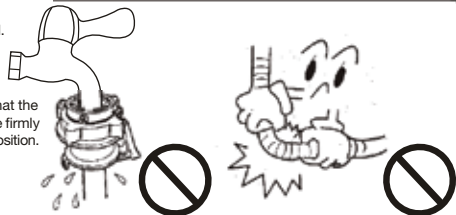

Dismantle the inlet hose

1. Close the tap.
2. Press the locking lever, push down the slider, and pull off the inlet hose. If the machine is used frequently, the connector of the inlet hose can be kept on the tap to prevent damage to the fixing screw.

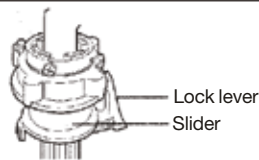

Preparation before operation

Operation

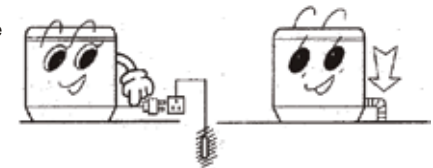

Preparation before washing

1. Connect the inlet hose and open the tap.
2. This appliance must be earthed. Confirm the socket is earthed reliably and insert the power plug. The earth terminal should not link to the gas pipeline, tap pipeline etc.
3. Put down the drainpipe.



Warning: The temperature of the water should be less than 50°C!

Before washing the laundry, please pay attention to the following:

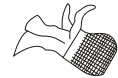
<p>Make sure if there are any special requirements for the laundry.</p>	<p>Before washing, empty all the pockets of small objects, which may have been left inside (coins, keys, screws etc.) as these could damage the drain pump.</p>	<p>Knot the long band, fasten the buttons and close the zippers.</p>	<p>Do not overload the machine. Load the laundry loosely alternating large items with small ones.</p>	<p>Sort the laundry according to the type of fabric, color-fastness and how dirty it is. Put thin laundry, woolens and such prone to wear and tear laundry into a washing bag.</p>
				

- A. Make sure the laundry is washable.
- B. It is essential to wash new colored items separately when washing for the first time. White items should not be washed with colored items.
- C. Please immerge the non-absorbable laundry by hand.
- D. Some stains such as fruit, wine, grass, rust etc. are difficult to remove and should be treated before washing with specific products, which can be found in most household shops. In some cases, it may help soak the stain before washing with a special pre-soak product or biological detergent.
- E. Overturn the nap fabric and long floss laundry before putting them into the machine.
- F. Do not put the laundry polluted by chemicals into the machine directly.
- G. Very small items (handkerchiefs, ribbons, socks etc.) should be washed in a washing bag or a pillow case.

Load laundry

Operation



- The capacity of washing and spinning of the machine refers to the largest weight of the standard laundry under dry conditions. Washing quantity shall be lower than the rated capacity.
- Different thickness, size and type of the laundry will influence the actual washing capacity. It is suitable that the laundry can be turned around normally during washing.
- Do not select high water level when the laundry is less.

Use of detergent

Detergent box

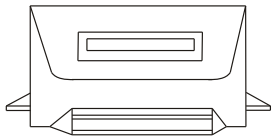

- Withdraw the dispenser box before adding the detergent.
- Pour concentrated synthetic washing powder into the box directly as shown in the left illustration.
- For the dosage of washing powder, please refer below.
- It is suggested to use low sud washing powder.

How to use the washing powder

- Dissolve in the machine directly (not suitable for preset program)
 1. It is suitable for low water level.
 2. Add the washing powder and run the machine for 30 seconds to dissolve it completely.
 3. Put the laundry in and select suitable water level.
- For instant dissolving of the washing powder
 1. Prepare warm water about 30 °C in a container.
 2. Pour the powder while stirring to fully dissolve it.
- The washing powder is more prone to pollute the laundry than the detergent, therefore, please use it in proper quantity.
- Washing powder with poor quality or not used for a long period may get blocked. Please clean the detergent box frequently.

How to use bleach

- Fill water to the selected level. Dilute the bleach in the container and pour it slowly into the washing tub.
- Do not use bleach for colored or figured laundries as they are prone to lose colors.
- Do not put bleach in the laundry directly.
- Refer to the manual for the usage and quantity of the bleach.
- Please dissolve powdered bleach before use.

- It is suggested to use low foam washing powder.
- For the quantity of the concentrated washing powder, please refer to its manual.
- Remarks: Avoid splashing of water and wastage of washing powder. Water level should not be too high, if the laundry is less.

Control panel instructions

Mode and meaning of the indicator light

- ☑ On: Indicates the selected mode.
- ⚡ Flashing: Indicates the program is running.

Additional functions

- At the start of the program, press WATER LEVEL and PRESET at the same time. This will give you an option to either select WATER RECYCLE, LOW NOISE, or LOW NOISE-WATER RECYCLE.
- If LOW NOISE is selected, then the program's default setting will be NORMAL and the PROGRAM button will get locked.
- If only RINSE and SPIN are selected, then WATER RECYCLE preset can be chosen.
- To set CHILD LOCK press WATER LEVEL and PRESET while the machine is working. To unlock, press the same buttons again.

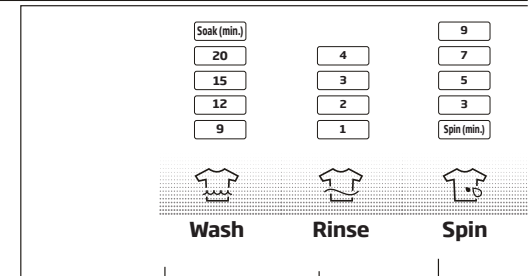

- With DIY program, you can set the spin time.
 - At the start of the program, the spin time setting is "7 minutes".
 - At the start of the program, you can press "SPIN" to set spin process only and press "SPIN" again to set spin time.
- With DIY program, you can set rinse time.
 - At the start of the program, the rinse time setting is "2 times".
- With DIY program, you can choose soak function and wash time.
 - Press "WASH" button for 2 seconds to choose soak function and press for 2 seconds again to cancel soak function.
 - Under "NORMAL" and "HEAVY" programs, you can choose soak function. The soak is before wash.
 - At the start of the program, the wash time is "15 minutes".

At the start of the program

- Put power supply through and press "POWER" button. Now the washing machine is at the start of the program:
1. If there is no water in the inner tub, the washing machine is in "FUZZY" condition. At this point, the washing time is "15 minutes", rinse time is "2 times", spin time is "7 minutes", water level and preset are displayed "--" and the program is "NORMAL" (or press "PROGRAM" to select "HEAVY"). If "START/PAUSE" button is pressed, the washing machine will automatically sense the weight of laundry. It will also set the water level and will adjust the time accordingly.
 2. If there is water in the inner tub, the washing machine is not in "FUZZY" condition. At this point, the washing time is "15 minutes", rinse time is "2 times", spin time is "7 minutes", water level is "7", program is "NORMAL", and digital time displays the time to finish washing.

- Before washing, the digital timer shows preset time. The unit displayed is HOUR.
- If AIR DRY is selected, the digital timer displays air dry time. The unit displayed is MIN.
- When washing, the digital timer shows the rest time of washing. The unit displayed is MIN.
- When trouble is encountered, the digital time shows trouble code.
- At the start of the program, if the machine is in FUZZY logic, the digital timer shows "--".
- After selecting the program, process and water level, press this button to start.
- Press this button to pause the working and press again to continue.
- To control the washing machine in working or waiting state.

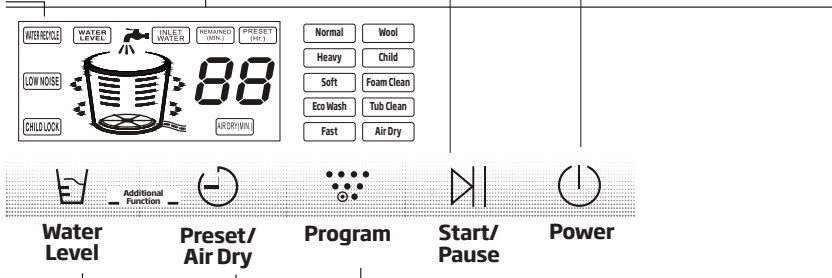

- You can select one program from NORMAL, HEAVY, SOFT, ECO WASH, FAST, WOOL, CHILD, FOAM CLEAN, TUB CLEAN and AIR DRY.
- If you choose "ECO WASH" program, then the wash time is "9 minutes", rinse time is "2", and spin time is "5 minutes". You can cancel one of the processes (but if you choose "SOAK", the wash time cannot be cancelled).
- If you choose "FAST" program, then the wash time is "9 minutes", rinse time is "1", and spin time is "3 minutes". You can cancel one of the processes (but if you choose "SOAK", the wash time cannot be cancelled).
- At the start of the program, the process is NORMAL.
- At the start of the program, press this button to select preset time from 2-24 hours.
- If you want to cancel the preset time, press POWER to put the washing machine in waiting state.
- If you need to select air dry, please press "PROGRAM" button to select air dry, then press this button to set air dry time.
- Fuzzy logic is present in Normal and Heavy cycles. When you select these cycles, it will take water level and set time as per the load. However, you may also select water level manually.
- At the start of the program, press WATER LEVEL to select the water level. At this time, the fuzzy logic function is not available. You can select appropriate water level according to the quantity of your laundry. 1-2 is low water level, 3-6 is middle water level, and 7-10 is high water level. During wash or rinse cycle, if you want to add extra water then you have two options:
 - Pause program, reselect water level and start machine.
 - Press water level button for a few seconds during operation and the machine will continue to take water till the button is pressed. After you release this button, the machine will start its operation.
- Automatically add water: During SOAK, WASH and RINSE processes, if the water level is lower than the setting water level, the washing machine will pause and will automatically add water to the setting water level.

● Power Button

Press this button once to operate. Press it again to turn the power off.

● Start/Pause Button

Use to pause and restart the operation. To change the washing procedure during an operation, press this button to stop, and again to restart after changing the procedure.

● Program Select Button

Each time the button is pressed, the washing programme changes.

● Remaining Time, Delay Start Time, Error Display

Displays the remaining wash time, reserved delay start time, and the error state if a problem occurs in the washing machine so that you can take action.

● Delay Start Time Button

Adjusts delay start time. Max. 24 h.

● Water Level Button

The water level is automatically adjusted. However, you can select the water level manually by pressing this button. The water level button is only active during standby status. The water level can be selected before the machine starts to run. If you want to change it while the machine is running, then press START/PAUSE, change the level and press START/PAUSE again. Displays selected programme's default water level. Low 1 to 10.

● Function Button

With every press of this button, the function changes.

Maintenance methods

After the end of the programme

- The machine will stop automatically and the buzzer will remind you to take out the laundry or start again.
- Once you have finished using the machine, you are advised to unplug it and turn off the water tap to avoid unexpected leak or fire.

External cleaning

Clean the exterior cabinet of the appliance with a soft cloth. Do not use cleanser or volatile chemical materials to clean the machine. These will damage plastic parts and the surface of the machine.



Magic filter cleaning

1. Pull out the magic filter.
2. Open the box and clean it.
3. Close it and reinstall it.
4. Check if the lint block part is in good condition. press and pull to take the magic filter out.

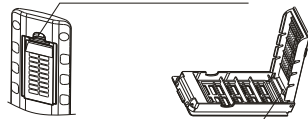

lint block part (black rubber)

Clean inlet gate

It is possible that the inlet filter net can be blocked by the dust. Please clean it according to the following steps:

1. Close the tap and turn on the power switch.
2. Start the washing machine for 5 seconds (let the water in the inlet hose flow to the tub), and cut off the power supply.
3. Pull off the inlet hose, remove and clean the inlet valve and the inlet net, and install again.



1. Once you have used the machine, you are advised to turn off the water tap. (If necessary, pull out the inlet hose).
2. Do not keep the water in tub for a long time. When washing is finished, drain it right away.
3. Once you have finished using the machine, you are advised to unplug it.
4. Put the electric cable and the drain hose in order.
5. Wipe the water on the surface and in tub with a soft cloth and keep the top lid open for a while. It helps prevent mould and stagnant smells from forming inside the appliance.

If the water in the inner tub has possibility to freeze, please do like below:

1. In winter, if the remaining water freezes, it can cause the washing machine trouble. Please take off the water inlet hose and drain out the water from the hose and inner tub.
2. If the water freezes, please don't operate the washing machine. Put 40°C hot water in the tub. The hot water should submerge the pulsator. After a few minutes, rotate the pulsator by hand gently. Now, you can operate the washing machine.

Before contacting the technicians, please make the following checks:

Phenomena	Possible reason
Control panel has no display	Plug is not inserted tightly. No electricity in the socket. Power switch is not turned on. Power supply is cut off.
Inlet hose leaks	Inlet hose connector (connecting with the tap) is not fixed tightly. Inlet hose and washing machine connector is loose.
It does not drain	Drainpipe is not put down. Drainpipe is bended or blocked.
It does not inlet	No water supply. Tap is not open. Inlet hose is blocked.
Spinning stops and begins to supply water during spin program	Laundry has been overloaded or underloaded or the machine is not placed on a stable surface.
Press the program button to select SPIN, but it does not work	The top lid is closed when the water is draining.
The spin is intermittent when spinning starts	Balance the laundry to reach to the best spin effect.
When used for the first time, some water flows from the drainpipe	Because of the remaining water inside, when the factory did the test.

Settlement	
	Insert the plug tightly. Make sure the socket is functioning, else change to another socket. Press power switch. Check power supply.
	Install the inlet hose again. Tighten the connector of the machine.
	Put down the drainpipe. Straighten or clean the drainpipe.
	Restart when water supply is resumed. Open the tap. Clean the filter according to before "clean inlet gate".
	The machine is adjusting automatically.
	Close the top lid.
	Normal
	Normal

Notes: If there is still a fault after the above checks, please pull out the plug and contact the seller right away. It is dangerous to repair this product by yourself.

Other functions

1. Give an alarm

Display	Explanation	Settlement
E0	The top lid is opened when preset is started.	Close the top lid and clear up the alarm.
E1	After draining for 5 minutes, it still does not reach to the water level.	Open top lid, according to before troubleshooting and settlement to settle it, then close the top lid and clear up the alarm.
E2	The top lid is open while spinning.	Close the top lid and clear up the alarm.
E3	Spin does not balance.	Open the top lid, place the laundry equally, then close it and clear up the alarm.
E4	After 40 minutes, the inlet still does not reach to the setting water level.	Open top lid, according to before troubleshooting and settlement to settle it, then close the top lid and clear up the alarm.
E5 Child-lock light flashing synchronously.	The top lid is opened after setting child-lock.	Close the top lid and clear up the alarm.
F1	Water level sensor is wrong.	Cut the power supply and call the technicians.

2. Imbalance adjustment

During spinning, if the laundry is not placed equally in the tub, it would cause the machine to vibrate violently. This machine has imbalance adjustment function and the vibration testing system will supervise the running. Once vibration is beyond certain level, the adjustment system will start to adjust the imbalance automatically.

3. Power supply is cut off automatically

- 1) Press the power supply button. If it does not start the program in 10 minutes, the power supply will be cut off automatically.
- 2) After the washing is finished, the buzzer will remind, and the power supply will be cut off automatically.

4. Child lock function

- (1) If you set child lock function, all the buttons will be locked including POWER. If the top lid is opened while the washing machine is working, the washing will stop and the machine will give an alarm. But if you close the top lid in 5 seconds, the washing machine will stop the alarm and continue working. If you do not close the top lid in 5 seconds, the washing machine will begin draining if there is water in the inner tub. Even closing the top lid now will not work. During the draining, alarm will be given every 10 seconds. When the water in the inner tub is about 5 cm higher, alarm will be given every 10 minutes (alarm is always given). When the draining is finished, the washing machine will be in the state of waiting. If the top lid is closed, the washing machine is unlocked and will start working as per the previous setting.
- (2) Once child lock is set and the top lid is opened in 5 seconds during washing or rinse (there is water in the inner tub), washing machine will drain and give an alarm. If you unlock the function during draining, the washing machine will add water to setting water level and continue working.

5. Water recycle function

If you set water recycle function, after the last rinse is finished, the washing machine will not drain and spin. The SPIN and WATER RECYCLE indicator light will flash and an alarm will be given. The washing machine will stop working (if nobody operates, the alarm will be given every 10 minutes and in 1 hour, power supply will be cut off automatically). When you press START/PAUSE, the WATER RECYCLE indicator light will turn on and the washing machine will begin to drain and spin. The user can reuse the water.

Dawlance

وسیع ترین سروس سینٹر نیٹ ورک ملک بھر میں 200 سے زائد مراکز کیساتھ

ڈاؤ لینس ریلائبل سروس تمام گھریلو مصنوعات کے لئے
سروسز آپ کی دہلیز پر 24 گھنٹے کے اندر
کال سینٹر کی سہولت پورا ہفتہ 24 گھنٹے

UAN # 021-111-11-7359 (RELY)

Head Office: Dawlance Center 7/4, Civil Lines-9

Dr. Ziauddin Ahmed Road, Karachi.

Ph: (021) 35652450-9

E-mail: customer.service@dawlance.com.pk

Website: www.dawlance.com.pk

ڈاؤ لینس ریلائبل ہے!