



TV USER MANUAL (Start Guidebook)

品牌名称 (BRAND NAME)	DAWLANCE
销售型号 (SALES MODEL)	32E3A/43E3A

<p>材质印刷及质量要求： 1.80G双胶纸黑白印刷。 2.骑马钉尺寸 A5 (148*210mm)(公差+/-2)。 3.符合RoHS最新标准。 4.质量技术要求同企标Q/SCWB 2136-2021。</p> <p>Material and printing requirements: 1.80G double adhesive paper black and white printing 2.Horse riding nail A5 (tolerance +/-2). 3.Meet the latest RoHS standards. 4.Quality and technology requirements are same as company standard "Q/SCWB 2136-2021".</p>	深圳创维-RGB电子有限公司 SHENZHEN CHUANGWEI-RGB ELECTRONICS CO., LTD.			
	产品型号 (MODEL)	32E3A/43E3A	单 位 (UNITS)	
	物料名称 (TITLE)	快速操作指南	零件编号 (PART NO.)	N080105-
	材 料 (MATERIAL)	双胶纸	模具编号 (MOLD NO.)	
	表面处理 (FINISH)		绘制/日期 (DWN./DATE)	刘东海 2022-3
	比 例 (SCALE)	1:1	校核/日期 (CHK./DATE)	马洋
	视 角 (PROJECTION)		批准/日期 (APP./DATE)	陈军霞

SPECTRUM SERIES

LED TV



32E3A (HD TV)
43E3A (FHD TV)

- Please read this User manual for details
- Keep this in safe place for Troubleshooting

Preparation

Unpacking and Installation

Note: The pictures are only for reference.

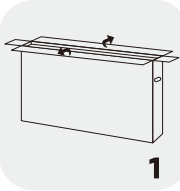

1

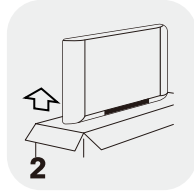

2



3

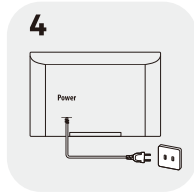

4

1. Open the package.
2. Take out the TV.
3. Install the TV stands.
4. Connect the power cord.

Standard Accessories

Note: The pictures are only for reference.



Batteries/2



Remote Control



32":Screws/2
43":Screws/4

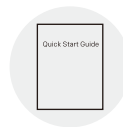

Quick Start Guide



Base Stands/2

Stand Installation

Step 1: Take out the TV and carefully put it (screen downward) on a stable and flat table with a soft cloth or cushion on it.

Step 2: Please check to make sure there is the same mark(A/B) on the TV back and the correct stand base. This step is not available for the bases without any mark on it, or not available for the TV with one stand base only.

Step 3: Fix the stand bases to the TV by fastening the matching screws provided in the box. The bases may vary depending on the region or model.

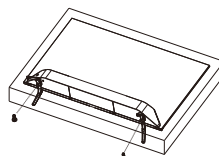
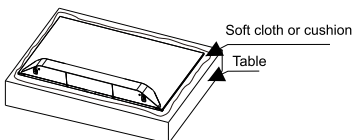

For 32"

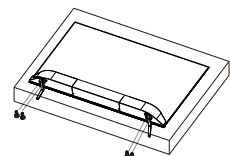

For 43"

Warning and Precaution

Read all of the instructions before operating the set. Keep these instructions well for later use.

Important Safety Instructions

- Read these instructions – All the safety and operating instructions should be read before this product is operated.
- Keep these instructions – The safety and operating instructions should be retained for future reference.
- Heed all warnings – All warnings on the appliance and in the operating instructions should be adhered to.
- Follow all instructions – All operating and use instructions should be followed.
- Do not use this apparatus near water – The appliance should not be used near water or moisture – for example, in a wet basement or near a swimming pool, and the like.
- Clean only with dry cloth.
- Do not block any ventilation openings. Install in accordance with the manufacturer's instructions.
- Do not install near any heat sources such as radiators, heat registers, stoves, or other apparatus (including amplifiers) that produce heat.
- Do not defeat the safety purpose of the polarized or grounding plug. A polarized plug has two blades with one wider than the other. A grounding plug has two blades and a third grounding prong. The wide blade or the third prong is provided for your safety. If the provided plug does not fit into your outlet, consult an electrician for replacement of the obsolete outlet.
- Protect the power cord from being walked on or pinched particularly at the plugs, convenience receptacles, and at the point where they exit from the apparatus. Only use attachments/accessories specified by the manufacturer.



- Use only with the cart, stand, tripod, bracket, or table specified by the manufacturer, or sold with the apparatus.

When a cart or rack is used, use caution when moving the cart/apparatus combination to avoid injury from tip-over.

- Unplug the apparatus during lightning storms or when unused for long periods of time.
- Refer all servicing to qualified personnel. Servicing is required when the apparatus has been damaged in any way, such as power supply cord or plug is damaged, liquid has been spilled or objects have fallen into the apparatus, the apparatus has been exposed to rain or moisture, does not operate normally, or has been dropped.

- **CAUTION:** These servicing instructions are for use by qualified service personnel only. To reduce the risk of electric shock, do not perform any servicing other than that contained in the operating instructions unless you are qualified to do so.
- Do not install this equipment in a confined or building-in space such as a book case or similar unit, and remain a well ventilation conditions at open site. The ventilation should not be impeded by covering the ventilation openings with items such as newspaper, table-cloths, curtains etc.
- ⚠ **CAUTION** – To prevent electric shock hazard, replace grille.
- Please refer the information on rear enclosure for electrical and safety information before installing or operating the apparatus.
- To reduce the risk of fire or electric shock, do not expose this apparatus to rain or moisture.
- The apparatus shall not be exposed to dripping or splashing and that no objects filled with liquids, such as vases, shall be placed on the apparatus.
- For the terminals marked with symbol of “⚡” may be of sufficient magnitude to constitute a risk of electric shock. The external wiring connected to the terminals requires installation by an instructed person or the used of ready-made leads or cords.
- To prevent injury, use the stand/wall-mount bracket to securely install this apparatus on the table/wall in accordance with the installation instructions.
- Danger of explosion if battery is incorrectly replaced. Replace only with the same or equivalent type.
- The battery (battery or batteries or battery pack) shall not be exposed to excessive heat such as sunshine, fire or the like.
- Excessive sound pressure from earphones and headphones can cause hearing loss. Listening to music at high volume levels and for extended durations can damage one's hearing. In order to reduce the risk of damage to hearing, one should lower the volume to a safe, comfortable level, and reduce the amount of time listening at high levels.
- The appliance coupler is used as disconnect device, the disconnect device shall remain readily operable.
- When not in use and during movement, please take care of the power cordset, e.g. tie up the power cordset with cable tie or something like that. It shall be free from sharp edges and the like that can cause abrasion of the power cordset. When put into use again, please make sure the power cordset being not damaged, If any damages found, please look for the service person to replace the power cordset

Warning and Precaution

specified by the manufacturer or have the same characteristics as the original one.

- Attention should be drawn to environmental aspects of battery disposal.
- No naked flame sources, such as lighted candles, should be placed on the apparatus. To prevent the spread of fire, keep candles or other open flames away from the apparatus at all times.
- If the apparatus have the symbol  in its rating label and the power cord has two pins, it means that the equipment is a Class II or double insulated electrical appliance. It has been designed in such a way that it does not require a safety connection to electrical earth.(Only for Class II appliance)
- The following information are recommended to be included as far as applicable where applicable:

~ Refers to alternating current(AC).

— Refers to direct current(DC).

 Refers to ClassII equipment.

⏻ Refers to stand-by.

I Refers to power ON.

⚡ Refers to dangerous voltage.

- Warning for Apparatus containing COIN / BUTTON CELL BATTERIES (Below instruction only used for the apparatus containing a user-replaceable coin/button cell battery)

WARNING:

Do not ingest the battery, Chemical Burn Hazard (The remote control supplied with) this product contains a coin/button cell battery. If the coin/button cell battery is swallowed, it can cause severe Internal burns in just 2 hours and can lead to death. Keep new and used batteries away from children. If the battery compartment does not close securely, stop using the product and keep it away from children. If you think batteries might have been swallowed or placed inside any part of the body, seek immediate medical attention.

- WEEE Directive

 indicates Correct Disposal of this product. This marking indicates that this product should not be disposed with other household wastes throughout the EU. To prevent possible harm to the environment or human health from uncontrolled waste disposal, recycle it responsibly to promote the sustainable reuse of material resources. To return your used device, please use the return and collection systems or contact the retailer where the product was purchased. They can take this product for environmental safe recycling.



- This lightning flash with arrowhead symbol within an equilateral triangle is intended to alert the user to the presence of non-insulated "dangerous voltage" within the product's enclosure that may be of sufficient magnitude to constitute a risk of electric shock.
- To reduce the risk of electric shock. Do not remove cover (or back). No user serviceable parts inside. Refer to qualified service personnel.
- The exclamation point within an equilateral triangle is intended to alert the user to the presence of important operating and maintenance instructions in the literature accompanying the appliance.

Warning and Precaution

Positioning the TV

- Install Display on solid horizontal surface such as a table or desk. For ventilation, leave a space of at least 10cm free all around the set. To prevent any fault and unsafe situations, please do not place any objects on top of the set. This apparatus can be used in tropical and/or moderate climates. Fix the rear of enclosure to wall (only for some countries).

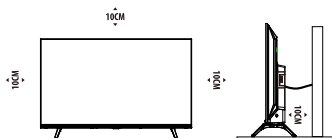

- **Warning: Stability Hazard**
A television set may fall, causing serious personal injury or death. Many injuries, particularly to children, can be avoided by taking simple precautions such as:
 - ALWAYS use cabinets or stands or mounting methods recommended by the manufacturer of the television set.
 - ALWAYS use furniture that can safely support the television set.
 - ALWAYS ensure the television set is not overhanging the edge of the supporting furniture.
 - ALWAYS educate children about the dangers of climbing on furniture to reach the television set or its controls.
 - ALWAYS route cords and cables connected to your television so they cannot be tripped over, pulled or grabbed.
 - NEVER place a television set in an unstable location.
 - NEVER place the television set on tall furniture (for example, cupboards or bookcases) without anchoring both the furniture and the television set to a suitable support.
 - NEVER place the television set on cloth or other materials that may be located between the television set and supporting furniture.
 - NEVER place items that might tempt children to climb, such as toys and remote controls, on the top of the television or furniture on which the television is placed.

If the existing television set is being retained and relocated, the same considerations as above should be applied.

Wall-hanging bracket

- An optional wall mount can be used with your television. Consult with your local dealer to purchase the recommended wall mount bracket. Carefully attach the wall mount bracket at the rear of the TV. Install the wall mount bracket on a solid wall perpendicular to the floor. If you are attaching the TV to other building materials, please contact qualified personnel to install the wall mount. Detailed instructions will be included with the wall mount. Please use a wall mount bracket where the device is adequately secured to the wall with enough space to allow connectivity to external devices.

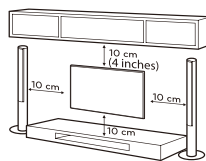

Note: The picture is only for reference.

- Disconnect the power before moving or installing the TV. Otherwise electric shock may occur.
- Remove the stand before installing the TV on a wall mount by performing the stand attachment in reverse.
- If you install the TV on a ceiling or slanted wall, it may fall and result in severe injury. Use an authorized wall mount and contact the local dealer or qualified personnel. Otherwise it is not covered by the warranty.
- Do not over tighten the screws as this may cause damage to the TV and void your warranty.
- To prevent injury, this apparatus must be securely attached to the floor/wall in accordance with the installation instructions.
- Use the screws and wall mounts that meet the following specifications. Any damages or injuries buy misuse or using an improper accessory are not covered by the warranty.

Warning and Precaution

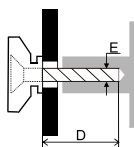
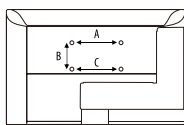

Model Size: 32"			Top	Down
Screw	Diameter(mm) "E"		M4	M4
	Depth(mm) "D"	Max	9	9
		Min	6	6
	Quantity		2	2
VESA (A*B*C)			200*200*200	

Model Size: 43"			Top	Down
Screw	Diameter(mm) "E"		M6	M6
	Depth(mm) "D"	Max	15	15
		Min	10	10
	Quantity		2	2
VESA (A*B*C)			200*200*200	

Note:

- 1) The pictures in this manual are for reference only.
- 2) For the TV sets with terminals towards the wall, in order to leave enough space to use the terminals, a rubber cushion is needed together with the screw to fix the wall mount. It is a small hollow pillar with a height of 30mm.
3. The information in this document is subject to change without notice. The manufacturer accepts no liability for damage resulting directly or indirectly from faults, incompleteness or discrepancies between the user manual and the product described.
4. In dry environment due to static electricity, the product may restart and return to the main OSD interface, USB player interface or the previous source mode. It is normal and please continue to operate the TV as you will.

Operating Environment

- Do not install this equipment in a confined space such as a bookcase or similar unit.
- Do not use the set near damp, and cold areas, protect the set from overheating.
- Keep away from direct sunlight.
- Do not use the set near dust place.
- Do not attach candle to accessible opening area, to avoid flammable foreign material from entering the TV.

Precautions For Using Remote Control

- Use the remote control by pointing it towards the remote sensor. The items between the remote control and the remote sensor will interfere the normal operation.
- Do not make remote control vibrate violently. Also, do not splash liquid on the remote control, also do not put the remote control in high humidity place.
- Do not place remote control under direct sunlight which will cause deformation of the unit by heat.
- When the remote sensor is under direct sunlight or strong lighting, the remote control will not work. If so please change the lighting or TV's position, or operate the remote control closer to the remote sensor.

Precautions For Using Battery

- Improper using of the battery will cause leakage. So please do as the following methods and use carefully.
1. Please note the batteries' polarity, to avoid short circuit.
 2. When the battery's voltage is insufficient which affect the use range, you should replace new battery. Remove the batteries from the remote control unit if you do not intend to use it for a long time.
 3. Do not use different types of batteries (for example, Manganese and Alkaline batteries) together.
 4. Do not put the battery into fire, and charge or decompose the battery.
 5. Please dispose batteries abide by relevant environmental protection regulation.
 6. WARNING: The batteries (battery pack or batteries installed) shall not be exposed to excessive heat such as sunshine, fire or the like.

Remote Control Function

Note:

- 1) The picture is only for reference.
- 2) Some buttons may not be available for some regions or some models.

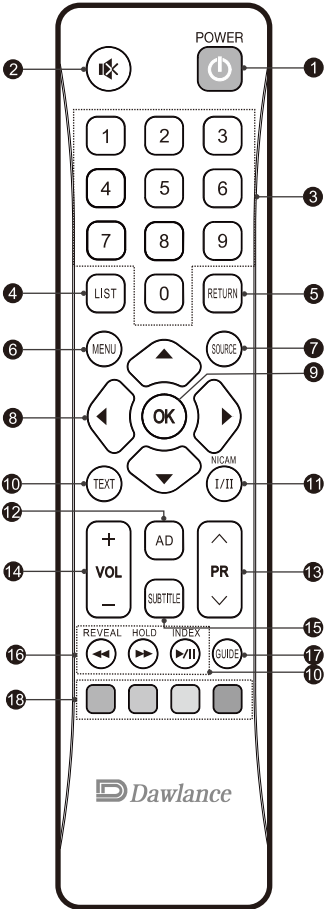

1. **POWER**(⏻): Turn the TV on or standby.
2. **MUTE**(🔇): Mute or restore the volume.
3. **Number buttons**: Choose the channel directly.
4. **LIST**: Access the channel list.
5. **RETURN**: Return to the previously viewed channel or exit from the TV menu.
6. **MENU**: Enter or exit from the TV menu.
7. **SOURCE**: Select the input source mode.
8. **UP/DOWN/LEFT/RIGHT** (▲ / ▼ / ◀ / ▶): Navigate the menu.
9. **OK**: Confirm the selection or show the detailed information.
10. **Teletext Buttons**
 - TEXT**: Enter the teletext menu.
 - Reveal**: Display concealed information.
 - HOLD**: Hold the teletext page on screen without updates or changes.
 - Index**: Display index page.
11. **NICAM I/II**: Select the desired sound output depending on the broadcasting channel.
12. **AD**: No function.
13. **Program Up/Down (PR^/PR~)**: Change to the next or previous channel.
14. **Volume Up/Down (VOL+/VOL-)**: Increase or decrease the sound volume.
15. **SUBTITLE**: Open or close the subtitle in USB mode.
16. **USB Play Control Buttons**
 - Fast Backward** (◀◀): Fast backward the playback.
 - Fast Forward** (▶▶): Fast forward the playback.
 - Play & Pause** (▶||): Pause or continue the playback.
17. **GUIDE**: Access the EPG interface.
18. **Color Buttons (RED/GREEN/YELLOW/BLUE)**: Execute the prompt function in specific mode.

Basic Operation

Install Remote Control Battery

Place two AAA size batteries in the remote controls battery compartment, making sure to match the polarity markings inside the compartment.

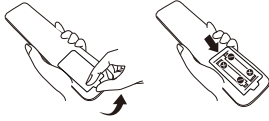

Note: The picture is only for reference.

TV Control Button

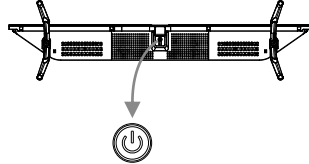

Note: The picture is only for reference.

How to use E-manual

E-manual are built into your TV and can be displayed on the screen. To learn more about your TV features, access your e-Manual by referring to the following.

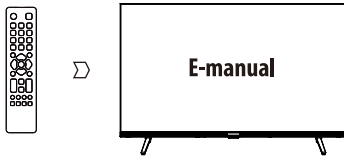

Note: The picture is only for reference.

- Turn on the TV:
In standby mode, short press TV control button to turn on the TV.
- Turn off the TV:
In working mode, short press TV control button to turn the TV standby.

1. Press MENU button to access the main menu.
There is a display "E-Manual" at the bottom.
2. Press BLUE button to access the E-Manual interface.
3. The following buttons on the remote control can be used to operate the TV in E-Manual interface.

0-9 Number Buttons	Select Page
OK	Go to page
⏪ ⏩	Go to the previous page. Go to the next page.
BLUE Button	Exit the E-manual.

Terminal Connection

Terminals

■ ANTENNA IN

Connect a coaxial cable to receive signal from the antenna or cable.

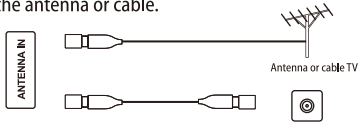

■ DIGITAL AUDIO OUT

Use a coaxial cable to output your TV audio signal to a compatible audio receiver.

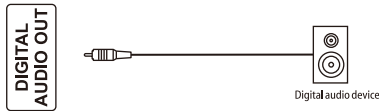

■ HDMI

Connect HDMI input signal from signal source such as DVD.

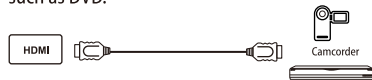

■ AV IN

Connect audio and video signal from signal source such as DVD.

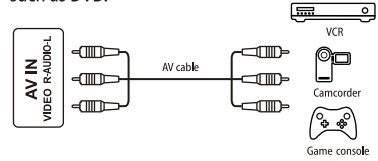

■ USB

USB port.

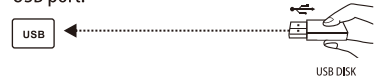

■ LINE OUT

Speakers won't be muted, and sound level is fixed.

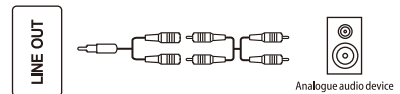

Note:

1) The pictures are only for reference.

2) External equipments and cables shown herein are not supplied with the TV.

3) Some terminals may differ by different regions or models, and please take your actual TV set as the standard.

Troubleshooting

Before calling a service technician, please check the following table for a possible cause of the symptom and some solutions.

■ General Problem / Solution

Remote control does not work

- . Check the remote sensor on the remote control.
- . Change the batteries.
- . Batteries are not installed correctly.
- . Main power is not connected.

Poor Signal

This is usually caused by interference from cell phones, walkie-talkie, automotive ignition system; neon, electric drill or other electronic equipment or radio interference sources.

■ Picture & Sound / Solution

No picture, no sound

- . Check the signal source.
- . Plug another electrical device into the outlet to make sure it is working or turned on.
- . Power Plug is bad contact with the outlet.
- . Check the signal.

No sound, picture OK

- . If no sound, do not mute or increase the sound volume.
- . Open the sound menu and adjust 'Balance'.
- . Check if a headphone has been inserted in, if so, pull out the headphone.

Abnormal picture

- . For no color or bad picture quality, you may:
 1. Adjust the color option in menu settings.
 2. Keep the TV at a sufficient distance from other electronic products.
 3. Try another channel, maybe exit broadcasting signal problem.
- . Bad TV signal (Display mosaic or snowflakes)
 1. Check the signal cable and adjust the antenna.
 2. Fine tune the channel.
 3. Try another channel.

■ Multimedia Player / Solution

'This file is invalid' appears or audio is normal but video is abnormal

- . The media file maybe damaged, check if the file can be played on the PC.
- . Check if video and audio codec is supported.

'Unsupported audio' appears or video is normal but audio is abnormal

- . The media file maybe damaged, check if the file can be played on the PC.
- . Check if video and audio codec is supported.

■ Network / Solution

(May not be available)

Network failure

- . Check if the router works well.
- . Make sure the TV has connected to the router successfully.

■ Browser / Solution

(May not be available)

Web page can not be displayed completely

- . Some third-party extensions are not supported.

Browser is forced to be shut down

- . Web page includes too many large pictures, thus leads to insufficient memory and close the browser.

Specification

Working voltage	100-240V~50/60 Hz
Dimensions (W x H x D) without stand	32": 718.2 X 426 X 84.8 mm 43": 954.5 X 558.3 X 88.2 mm
Net weight without stand	32": 3.5 Kg 43": 5.9 Kg
RF aerial input	75 ohm unbalanced
Language of OSD	Multiple options
System	ATV: PAL BG/DK/I/L + NTSC-M
Channel coverage	ATV: 48.25MHz~855.25MHz
Environment (only for Tropical climates zone)	Working temperature: 5°C~40°C Working humidity: 20%~80% Storage temperature: -15°C~50°C Storage humidity: 10%~90%
Environment (only for Moderate climates zone)	Working temperature: 5°C~40°C Working humidity: 20%~80% Storage temperature: -15°C~45°C Storage humidity: 10%~90%

Note: Some specifications may differ by different regions or models, and please take your actual TV set as the standard.

License



The Adopted Trademarks HDMI, HDMI High-Definition Multimedia Interface, and the HDMI Logo are trademarks or registered trademarks of HDMI Licensing Administrator, Inc. in the United States and other countries.



**The widest service center network in the country with
more than 200 outlets**



**Dawlance Reliable service is available for all
household products
Services at your doorstep within 24 hours
Call Center Services available
all week 24/7**

Service UAN # 021-111-11-7359 (RELY)

**Head Office: Dawlance Center 7/4, Civil Lines-9
Dr. Ziauddin Ahmed Road, Karachi.**

Ph: (021) 35652450-9

E-mail: customer.service@dawlance.com.pk

Website: www.dawlance.com.pk

ڈاؤلینس ریلائبل ہے!